

OPERATOR'S MANUAL

LATITUDE™

Programming System

REF 3300

Остаряла версия. Да не се използва.
Zastaralá verze. Nepoužívat.
Forældet version. Må ikke anvendes.
Version überholt. Nicht verwenden.
Aegunud version. Må ekki notuð.
Παλιά έκδοση. Μην την χρησιμοποιείτε.
Outdated version. Do not use.
Version obsolete. Ne pas utiliser.
Version périmée. Nemojte upotrebljavati.
Zastarjela verzija. Ne koristiti.
Úreilt útgáfa. Notið ekki.
Versione obsoleta. Non utilizzare.
Novecojsi versija. Nenaudokite.
Pasenusi versija. Neizmantot.
Elavult verzió. Ne használjál.
Dit is een verouderde versie. Niet gebruiken.
Wersja przeterminowana. Nie używać.
Versiune expirată. A nu se utiliza.
Zastarana verzija. Nepoužívat.
Zastarela različica. Ne uporabite.
Vanhentunut versio. Älä käytä.
Föråldrad version. Använd ej.
Güncel olmayan sürüm. Kullanmayın.

Table of Contents

INFORMATION FOR USE	1
Trademark Statement.....	1
Description and Use	1
Intended Use	1
Clinical Benefits of the Device.....	1
Intended Audience.....	2
Required Expertise and Knowledge	2
Medical Product Operator's Ordinance	2
Essential Performance	2
Summary of Safety and Clinical Performance.....	3
Contraindications.....	3
Warnings.....	3
Precautions	7
Adverse Effects	11
SYSTEM CAPABILITIES	12
Hardware	12
Interrogation and Programming	12
Patient Data Management	13
Networking	13
Heart Connect	13
Automated Screening Tool.....	13
Software	13
ALTRUA™, INSIGNIA™ I, and NEXUS™ Pulse Generator Support	14
SYSTEM ACCESSORIES	14
Optional External Equipment	15
Stand.....	16
External Printer.....	16
USB Grounding Plug and Cable.....	16
External Display	17
Cellular Adapter	17
CONNECTIONS	17
Patient Side Panel (Right Side)	18
Physician Side Panel (Left Side).....	18
Indicator Lights.....	19
STAT Button	19
USING THE LATITUDE PROGRAMMING SYSTEM.....	19
Preparation for Use	19
Battery Charge Level and Charging.....	19
Prepare a Telemetry Wand.....	20
Cable Connections	20

Make Patient Side Connections	20
Make Physician Side Connections.....	22
Electrosurgical Cables.....	23
Prepare for Telemetry with a Transvenous PG	23
Startup	25
PSA Button	28
Quick Start Button	28
S-ICD Applications Button	28
Patient Data Management Button	28
STAT Button for Transvenous PGs	28
STAT Button for S-ICD PGs	30
Start a Transvenous PG Session	30
Quick Start (Button).....	31
Select PG (Button).....	31
Start an S-ICD PG Session	31
Surface ECG	32
ECG Display	32
Intracardiac Electrogram	33
Pacing System Analyzer (PSA)	33
Patient Data Management Utility	33
Parameter Changes, Data Entry, Demo Mode, and Utilities	34
Changing Parameter Values.....	34
Demo Mode	35
Utilities Button	36
Setup - Configure Settings.....	36
Date and Time Tab.....	36
Network Setup Tab	37
Software Update Tab	37
About Button	39
Selecting a Transvenous PG	39
Real-time Log for Transvenous PGs	41
Real-time Log Tools	43
Electronic Calipers.....	43
Real-time Log Events	43
MAINTENANCE.....	45
Cleaning the Programmer and Accessories	45
Cleaning Cables and Wands.....	45
Disinfecting the ECG Cable	46
Sterilization.....	46
Battery Status, Installation, Replacement, and Recycling	47
Battery Replacement.....	49
Battery Recycling.....	51

Operation and Storage	51
Storing the LATITUDE Programming System.....	52
Maintenance Check and Safety Measures	53
LATITUDE Programming System Maintenance Check	53
Safety Measurements.....	53
Service	54
TROUBLESHOOTING	54
HANDLING	59
Using an External ECG Monitor with the Model 3300 Programmer.....	59
Environmental Protection and Disposal	61
Symbols on Devices and Packaging	61
SAFETY, COMPLIANCE, AND COMPATIBILITY STANDARDS	65
Safety Standards	65
Electromagnetic Compatibility Standards.....	65
Radio Spectrum Compliance Standards	65
Electromagnetic Emissions and Immunity	66
IEC 60601-1-2:2014 Information	66
Industry Canada (IC)	66
LATITUDE PROGRAMMING SYSTEM SECURITY.....	68
Software	68
Patient Data Management	69
Network.....	69
Unsupported Hardware.....	69
Security Vigilance.....	69
Physical Controls	69
Compromised Programmer.....	69
SPECIFICATIONS	70
WARRANTY INFORMATION	74
European Union Importer	74

Остаряла версия. Да не се използва.
Zastaralá verze. Nepoužívat.
Forældet version. Må ikke anvendes.
Version überholt. Nicht verwenden.
Aegunud version. Må ekki notuð.
Παλιά έκδοση. Μην την χρησιμοποιείτε.
Outdated version. Do not use.
Version obsolete. Ne pas utiliser.
Version périmée. Nemojte upotrebljavati.
Zastarjela verzija. Ne uporabite.
Úrejt útɡáfa. Notið ekki.
Versione obsoleta. Non utilizzare.
Novcojusi versija. Nenaudokite.
Pasenusi versija. Neizmantot.
Elavult verzió. Ne használjal.
Dit is een verouderde versie. Niet gebruiken.
Utdatert versjon. Skal ikke brukes.
Wersja przeterminowana. Nie używać.
Versão expirada. Não utilize.
Versiune expirată. A nu se utiliza.
Zastaraná verzija. Nepoužívat.
Zastarela različica. Ne uporabite.
Vanhentunut versio. Älä käytä.
Föråldrad version. Använd ej.
Güncel olmayan sürüm. Kullanmayın.

INFORMATION FOR USE

Trademark Statement

The following are trademarks of Boston Scientific Corporation or its affiliates: AF Monitor, EMBLEM, ImageReady, LATITUDE, LATITUDE NXT, Quick Start, ZIP, ZOOM, Heart Connect, ALTRUA, INSIGNIA, and NEXUS.

The Bluetooth® word mark and logos are registered trademarks owned by Bluetooth SIG, Inc. and any use of such marks is under license.

DisplayPort is a trademark of the Video Electronics Standards Association (VESA).

All other trademarks are the property of their respective owners.

Description and Use

Seven separate Operator's Manuals describe the LATITUDE Programming System:

1. *LATITUDE™ Programming System Operator's Manual (Model 3300)*
2. *Pacing System Analyzer (PSA) Operator's Manual (Model 3922)*
3. *Patient Data Management Operator's Manual (Model 3931)*
4. *Network and Connectivity Operator's Manual (Model 3924)*
5. *Heart Connect™ System Operator's Manual (Model 3932)*
6. *EMBLEM™ S-ICD Automated Screening Tool (AST) Instructions for Use (Model 3889)*
7. *EMBLEM™ S-ICD Application Operator's Manual (Model 3877)*

These manuals are also available online at:
www.bostonscientific-elabeling.com.

The Model 3300 Programmer is the programming device of the LATITUDE Programming System, which is a portable cardiac rhythm management system designed to be used with specific Boston Scientific systems, i.e., implantable pulse generators (PGs) and leads.

Intended Use

The LATITUDE Programming System is intended for use in hospital and clinical environments to communicate with Boston Scientific implantable systems. The software in use controls all communication functions for the PG. For detailed software application instructions, refer to the associated product literature for the PG being interrogated.

Clinical Benefits of the Device

The Model 3300 LATITUDE™ Programming System provides a direct clinical benefit to the patient by non-invasively communicating with the cardiovascular implantable electronic device (CIED) to record data pertaining to the patient's health and indicators of device function; allowing the medical team to monitor, adjust, and optimize the capabilities of the implantable device, as needed, through interrogation and/or programming of the implantable device based on the accurate transmission of information. In addition, the Programming System allows transmission of software updates to the implantable device for periodic changes to its operating software, ensuring the device operates as intended in a safe and effective manner.

The Model 3300 LATITUDE™ Programmer contains an integrated Pacing System Analyzer (PSA), and the Model 3922 PSA software support application, which eliminates the need for a stand-alone PSA device. The benefit of using the PSA as an integrated function of the programmer includes being able to measure and record device parameters required during device implantation, and to verify lead system status at device changeout, including lead impedance, pacing threshold, and sensing threshold. The PSA has the added clinical benefit to be used for temporary pacing from an external source during device implantation, while the patient is being continuously monitored by medical personnel. The PSA is contraindicated as a permanent external pacemaker.

Intended Audience

This literature is intended for use by health care professionals trained or experienced in device implant and/or follow-up procedures.

Required Expertise and Knowledge

Users must be thoroughly familiar with electrotherapy of the heart. Only qualified medical specialists having the special knowledge required for the proper use of the device are permitted to use it.

Physician Supervision

The LATITUDE Programming System may only be operated under the constant supervision of a physician. During a procedure, the patient must be continuously monitored by medical personnel with the aid of a surface ECG monitor.

Medical Product Operator's Ordinance

National regulations may require that the user, manufacturer or manufacturer representative perform and document safety checks of the device during installation. They may also require that the manufacturer or its representative provide training to users on the proper use of the device and its accessories.

If you do not know the national regulations in your country, please contact your local Boston Scientific representative.

Essential Performance

In order for the LATITUDE Programming System to meet its intended use, it must communicate with Boston Scientific implantable PGs. Therefore those functions that pertain to communications with the implanted PGs using telemetry wands are considered essential performance.

LATITUDE Programming System performance determined to be essential by Boston Scientific for electromagnetic compatibility testing, as per IEC 60601-1-2, has the ability to:

- Interrogate and program a supported PG using wanded telemetry
- Initiate a PG STAT PACE, PSA STAT PACE, STAT SHOCK, or DIVERT THERAPY command to a PG where supported
- Display real-time intracardiac electrograms
- Support touchscreen tap and button press interactions
- Deliver pacing and assess pace sense lead measurements with the Pacing System Analyzer (PSA) function

NOTE: No recurring calibration of the LATITUDE Programming System or its applications is required or needed.

Summary of Safety and Clinical Performance

For customers in the European Union, use the device name found in the labeling to search for the device's Summary of Safety and Clinical Performance, which is available on the European database on medical devices (Eudamed) website:

<https://ec.europa.eu/tools/eudamed>

Contraindications

The LATITUDE Programming System is contraindicated for use with any PG other than a Boston Scientific PG. For contraindications for use related to the PG, refer to the associated product literature for the PG being interrogated.

The PSA application is contraindicated for use with any programming system other than the Boston Scientific LATITUDE Programming System, Model 3300.

The following uses of the PSA are contraindicated:

- With AV conduction disorders; atrial single-chamber pacing
- With competing intrinsic rhythms; asynchronous modes
- With chronic atrial tachycardia as well as chronic atrial fibrillation or flutter; modes with atrial control (DDD, VDD)
- With poor tolerance of high ventricular rates (e.g., with angina pectoris); tracking modes (i.e., atrial control modes) and propensity for atrial tachycardia
- Use as an external pacemaker¹

WARNINGS

- **Use of unspecified cables and accessories.** The use of any cables or accessories with the LATITUDE Programming System other than those provided by or specified by Boston Scientific could result in increased electromagnetic emissions, decreased electromagnetic immunity, or electrical shock of the LATITUDE Programming System. Anyone connecting such cables or accessories to the LATITUDE Programming System, including the use of MSOs (Multiple Socket Outlets), may be configuring a medical system and is responsible to ensure that the system complies with the requirements of IEC/EN 60601-1, Clause 16 for medical electrical systems.
- **Equipment modifications.** No modification of this equipment is allowed unless approved by Boston Scientific. Changes or modifications not expressly approved by Boston Scientific could void the user's authority to operate the equipment.
- **Radio frequency (RF) communications equipment.** Keep all RF communications equipment (including peripherals such as antennas, wands, and cables) at least 30 cm (12 in.) away from the Model 3300 Programmer, including cables specified by Boston Scientific, to avoid degradation of the performance of this equipment.

1. During implantation, the PSA application is suitable for temporary external pacing while the patient is being continuously monitored by medical personnel.

- **Connector contacts.** Do not simultaneously touch the patient and any accessible LATITUDE Programming System connector or exposed conductor.
- **Electric shock.** To avoid the risk of electric shock, only connect the Programmer's Model 6689 Power Adapter with the appropriate power cord to a grounded/earthed power outlet.
- **Battery access.** When accessing the battery, ensure that power to the Programmer is turned off. Do not touch the connector terminals in the battery compartment while removing or replacing the battery because an electrical charge is present.
- **Electrostatic charges.** The PSA lead system is in electrical contact with the patient's heart and blood.
 - Do not touch the metal clips on the patient cable or the pacing lead. Electrical currents can be dangerous to the patient and the user.
 - Discharge any electrical static charge on your person by touching a grounded metal surface before touching the patient, the patient cables, or the device.
- **Electrical currents.** Unused PSA cable connections contacting conductive surfaces can induce electrical currents into the patient's heart.
 - Attach unused cable connections to surgical draping near the patient or disconnect the unused cables from the system.
- **Electrocautery.** The LATITUDE Programming System is designed and tested to be electrocautery safe.
 - While the device is designed and tested to be electrocautery safe, electrocautery can induce electrical currents in the PSA cables that can be conducted into the patient's heart. However, Boston Scientific recommends that the Programmer be placed as far from the electrocautery system and associated components as possible to minimize noise being introduced into the LATITUDE Programming System and patient cables.
 - Electrocautery may also produce unexpected behavior in the Programmer display or operation. If electrocautery is medically necessary, maintain a distance of at least 30 cm (12 inches) between electrocautery equipment and the Programmer and its associated components. Similarly, maintain this distance between the Programmer and its associated components and the patient during these procedures.
 - Do not drape electrocautery components or cables on or near the Programmer or associated cables and components.
 - Whenever possible disconnect the PSA cables from the pacing leads when performing an electrocautery procedure.
 - If the Programmer is connected to the patient during an electrocautery procedure, check its operation afterwards.
 - If the Programmer experiences an issue that causes an error condition, the Programmer will need to be power cycled. During the reset and reboot, which takes up to one minute, there will be no pacing support. For this reason, a backup PSA/pace resource must be available in case electrocautery is applied.
- **LATITUDE Programming System location.** Use of the Model 3300 Programmer adjacent to or stacked with other equipment should be avoided because it could result in improper operation. If such use is necessary, this equipment and the other equipment should be observed to verify that they are operating normally.

- **LATITUDE Programming System must remain outside sterile field.** The Programmer is non-sterile and cannot be sterilized. Do not allow the device to enter a sterile zone in an implant environment.
- **Physiological signals.** Operation of the LATITUDE Programming System with physiological signals that are lower than the minimum detectable amplitude may cause inaccurate results.
- **LATITUDE Programming System is MR unsafe.** The LATITUDE Programming System is MR Unsafe and must remain outside the MRI site Zone III (and higher) as defined by the American College of Radiology Guidance Document on MR Safe Practices². Under no circumstances should the LATITUDE Programming System be brought into the MRI scanner room, the control room, or the MRI site Zone III or IV areas.
- **Induction.** When activating PSA Burst Pacing, which may cause unpredictable arrhythmias, always have cardiac emergency equipment (e.g., external pacemaker, external defibrillator) in an operational status available for immediate life support.
 - Consider additional preemptive measures in patients where acceleration or a loss of rhythm could cause life-threatening danger.
- **External defibrillation.** The LATITUDE Programming System is designed and tested to be defibrillation safe.
 - While the Programmer is designed and tested to be defibrillation safe, the patient can be endangered and the Programmer can be damaged.
 - The PSA cable **must** be disconnected from the lead(s) before using external defibrillation.
 - Whenever possible, disconnect all cables from the patient when using external defibrillation equipment.
 - If the LATITUDE Programming System is connected to the patient during defibrillation, verify that the Programmer is operating as expected after defibrillation.
- **Loss of power.** Operating the Programmer with a depleted internal battery can suspend Programmer function. Operating the Programmer with no battery can suspend Programmer function if AC power is temporarily interrupted.
 - If the battery has been depleted to 10% or less, the Programmer may need to be powered Off to allow charging to begin and then may be powered back On to continue charging.
 - If an optional battery is used, do not use a depleted or unapproved battery. For additional patient safety, when the battery level indicator shows 25% or less remaining, connect the AC power to the Programmer.
 - When operating on battery power, do not attempt to replace the battery.
 - A yellow attention message displays on the Programmer screen when the battery reaches 25% depletion. When the battery reaches 10% depletion or less, a red warning message displays. At 5%, there is another red warning message followed by a 60-second automatic shutdown.
- **Loss of pacing support.** Always have external cardiac pacing equipment in an operational status available for immediate life support.

2. Kanal E, Barkovich AJ, Bell C, et al. ACR guidance document on MR safe practices: 2013. J. Magn. Reson. Imaging 2013;37:501-530.

- Initially, when the Programmer is switched on, the pacing functions of the PSA are switched off while a self-test is conducted. It is not possible to initiate pacing support until after the self-test has completed, which can take up to one minute.
- Connecting the PSA cable to the wrong lead may result in ineffective sensing and pacing behavior and loss of pacing support.
- If the Programmer encounters a fault condition, pacing operation continues until a restart is initiated unless the fault was in the PSA component itself.
- When the user manually restarts the Programmer, pacing support will be lost. The user must manually reinitiate PSA pacing after the system has completed the self-test. The self-test can take up to one minute.
- If there is no battery installed or the battery is depleted (5% or less), pacing support will be lost if AC power is lost.
- Consider additional preemptive measures in patients where loss of pacing could cause life threatening danger.
- **Backup defibrillation protection.** Always have external defibrillation equipment and medical personnel skilled in CPR available during implant and follow up testing. If not terminated in a timely fashion, an induced ventricular tachyarrhythmia can result in the patient's death.
- **Impaired AV conduction.** Single chamber atrial modes are contraindicated for patients with impaired AV conduction.
 - If the patient has impaired AV conduction, AAI programming and antegrade conduction tests must not be performed.
- **Abruptly terminating pacing.** Abruptly terminating pacing may result in extended periods of asystole in some patients.
 - Gradually decrease the pacing rate until the patient's intrinsic rate is detected for a controlled transition from pace to intrinsic rhythm.
- **Loss of capture.** Pacing threshold testing implies loss of capture. At loss of capture, asystole and pacing during vulnerable periods can occur.
 - Consider the health of the patient prior to performing a pacing threshold test.
- **Use of protective sleeves.** Incorrect positioning of the protective silicone rubber sleeves over the PSA cable clip(s) can cause unintended electrical connections that can impair cable function and endanger the patient.
 - Before connecting cables, ensure correct position of protective sleeves.
- **Do not use wet cables.** Moisture on wet cables can impair cable function and endanger the patient.
- **Exposure to fluids.** Before cleaning and disinfecting the Programmer surfaces, power down the device and disconnect the external power supply. Before operating the LATITUDE Programming System, let cleaning and disinfection agents used on the Programmer evaporate.
- **Emissions and interference.** The emissions characteristics of this equipment make it suitable for use in industrial areas and hospitals (CISPR 11 class A). If it is used in a residential environment (for which CISPR 11 class B is normally required), this equipment might not offer adequate protection to radio-frequency communication services. The user might need to take mitigation measures, such as relocating or

reorienting the equipment. Other equipment may interfere with the LATITUDE Programming System, even if that equipment complies with the CISPR emission requirements.

- **Lithium-ion battery.** The Model 6753 Battery is a Lithium-ion battery and, as such, is deemed a Dangerous Good in regards to shipping. Do not return the Model 6753 battery to Boston Scientific. Dispose of the battery as required by local regulations. If the battery must be shipped, contact your local shipper for instructions and shipping requirements.
- **Power up.** Do not touch the screen while the Programmer is powering up, as this may cause the area that you touched to become unresponsive when pressed later on.

EMBLEM S-ICD Warnings

For warnings specific to programming the EMBLEM S-ICD pulse generator, refer to the *EMBLEM™ S-ICD Application Operator's Manual (Model 3877)*.

PRECAUTIONS

- **Functional impairment due to external damage.** Mechanical impact, for example dropping the Programmer unpackaged, can permanently impair the function of the system. Do not use the Programmer if there is apparent damage. If damage has occurred, contact Boston Scientific to return the Programmer using the information on the back cover of this manual.
- **LATITUDE Programming System.** Use only the appropriate software to program specific Boston Scientific PGs.
- **Model 6395 Telemetry Wand use.** For inductive PG telemetry, use only the Model 6395 Telemetry Wand with the LATITUDE Programming System.
- **Wand temperature (Model 6395 only).** Telemetry procedures exceeding 8 hours may require a thermal insulator between the Model 6395 Telemetry Wand head and the patient's skin as the wand head temperature can range from 33 - 41 °C (88 - 106 °F).
- **Model 6395 Telemetry Wand shipped non-sterile.** The Model 6395 Telemetry Wand is shipped non-sterile. Remove the wand from all packaging material before sterilizing it. If the wand is to be used in a sterile field, it must be actively sterilized before use or enclosed in a sterile Model 3320 Intraoperative Probe Cover during use. Refer to "Cleaning the Programmer and Accessories" on page 45 for sterilization and cleaning information.
- **Model 3203 S-ICD Telemetry Wand shipped non-sterile.** The Model 3203 S-ICD Telemetry Wand is shipped non-sterile. Remove the wand from all packaging material before use. If the wand is to be used in a sterile field, it must be enclosed in a sterile Model 3320 Intraoperative Probe Cover during use. Refer to "Cleaning the Programmer and Accessories" on page 45 for cleaning information.
- **Model 3203 S-ICD Telemetry Wand use.** For S-ICD PG telemetry, use only the Model 3203 S-ICD Telemetry Wand with the LATITUDE Programming System.

For transvenous PG programming, the Model 3203 S-ICD Telemetry Wand may be used as an auxiliary antenna to improve RF telemetry performance (see "External antenna usage for RF telemetry with transvenous PGs" on page 10).

- **Stylus use.** If you want to use a stylus, ensure that it is a projected capacitance stylus. The use of any other object could damage the touchscreen.
- **Electrocautery cables.** Keep all electrocautery cables at least 30 cm (12 in) away from the LATITUDE Programming System to avoid false signals due to electrocautery energy.
- **Leakage current.** Although optional external equipment connected to the Model 3300 Programmer must meet the applicable leakage-current requirements for commercial products, it may not meet the more stringent leakage requirements for medical products. Consequently, all external equipment must be kept outside the patient environment.
 - Never touch the electrical contacts on the side panels of the Model 3300 Programmer and the patient, a telemetry wand, or any cable at the same time.
- **PSA connections.** Ensure leads are connected appropriately for desired use; incorrect setup can result in pacing/sensing events, which display under a different chamber on the screen. The PSA application user interface associates specific lead connections with the RA, RV, and LV chambers on screen to support testing all three chambers with minimal change of physical connections. Saved PSA measurements are also labeled automatically based upon the chamber in use on the screen. These labels can later be adjusted by the user if the decision is made to use one physical connection to test other chambers (for example, using only the RV connection to test RA, RV, and LV leads).
- **PSA connector clips.** Do not clip any PSA connector directly to the skin, pocket, or other tissue of the patient.
- **Ventricular Sensing.** During a PSA session, ventricular sensing behavior is driven by the most recently selected ventricular pacing configuration: RV-only, LV-only, or Bi-V.
 - At system startup, the PSA mode is set to ODO (non-pacing) and the effective ventricular pacing configuration is Bi-V.
 - When a non-pacing mode (ODO or OVO) is selected from the mode palette, sensing is set to Bi-V to ensure sensing is enabled on both leads regardless of any prior configuration.
- **Cross-chamber over-sensing.** A unipolar configuration may lead to cross-chamber artifact over-sensing that affects pacing behavior.
 - In a unipolar configuration, it is common to see cross-chamber artifacts on electrograms (EGMs). If you move the A+ connector clip back to the atrial lead anode while the Can electrode button and "Use the A+ connection" button are still selected, the PSA remains programmed to a unipolar configuration. In this case, you may see pronounced cross-chamber artifacts on the EGMs which may lead to over-sensing that affects pacing behavior.
- **ECG cable open/short.** Loss of the ECG signal in case of an ECG cable open/short can affect diagnosis and screening by prolonging the procedure or preventing the procedure from completing.
 - Check cables first and replace if cracked or worn.
 - If cable is not functioning properly, replace it.
- **Electrical and magnetic interference.** Electrical interference or "noise" from devices such as electrocautery and monitoring equipment, monitors, or strong magnetic

fields may interfere with establishing or maintaining telemetry for interrogating or programming the device and may produce unexpected behavior in the Programmer display or operation. In the presence of such interference, move the Programmer away from electrical devices, and ensure that the wand cord and cables are not crossing one another. Electrical interference or “noise” from concomitant implanted devices such as a ventricular assist device (VAD), drug pump, or insulin pump may interfere with establishing or maintaining telemetry for interrogating or programming the pulse generator. In the presence of such interference, place the wand over the pulse generator and shield both with a radiation-resistant material.

- **Electrocautery and RF ablation.** Electrocautery and RF ablation may induce ventricular arrhythmias and/or fibrillation, and may cause inappropriate shocks and inhibition of post-shock pacing and may produce unexpected behavior in the Programmer display or operation. Additionally, exercise caution when performing any other type of cardiac ablation procedure in patients with implanted devices. If electrocautery or RF ablation is medically necessary, maintain a distance of at least 30 cm (12 inches) between electrocautery and RF ablation equipment and the Programmer and telemetry wand. Similarly, maintain this same distance between the Programmer and telemetry wand and the patient during these procedures.
- **Model 6689 Power Adapter.** The power adapter normally gets warm when it is in use or charging. Do not place the power adapter in the storage pocket of the stand while it is in use or charging as the confined space will not allow the heat to dissipate adequately.
- **Ethernet.** If desired for use, connect the Ethernet cable only to the RJ45 Ethernet port connector on the Model 3300 Programmer. Insertion or removal of the Ethernet cable during operation may affect networking functions. The RJ45 Ethernet connection on the Model 3300 Programmer is for Local Area Networking (LAN) use only. It is not to be used for a telephone connection.
- **Inductive telemetry.** Using the Programmer on battery power only may reduce the telemetry distance (from wand to implanted device). If needed, use AC power to improve inductive telemetry.
- **Battery operation during long-term storage.** Remove battery to prevent discharging when storing the Programmer for long periods (e.g., months).
- **Date and time accuracy.** Inability to access a remote time server could lead to discrepancies in the Programmer time. As a backup, contact your Boston Scientific representative to have the time and date set manually.
- **Patient data.** Patient data may be stored on the Programmer and appropriate precautions should be taken to secure the Programmer from unauthorized access.
 - Patient data from transvenous PGs can be stored on the Programmer internal disk for up to 14 days.
 - Patient data from S-ICD PGs can be stored on the Programmer internal disk for up to 50 patient sessions for up to 90 days.

Before shipping the Programmer or at any time when the Programmer leaves your direct control, refer to the *Patient Data Management Operator’s Manual (Model 3931)* for instructions to delete all patient data (transvenous and S-ICD) from the Programmer.

Only connect to known Bluetooth® devices to reduce the potential of transmitting patient data to inappropriate printers or devices.

- **USB devices.** USB devices connected to the Programmer should be controlled to limit the potential introduction of malware.
- **External device battery usage.** Using external devices (USB, display monitor) will deplete the battery. To extend Programmer performance, refrain from using external devices when on battery power only and the battery level indicator shows 25% or less remaining.
- **Software.** Ensure that you have the latest software versions installed (see "Software Update Tab" on page 37). As a backup, your local Boston Scientific representative can provide software updates using a USB pen drive.
- **External antenna usage for RF telemetry with transvenous PGs.** The Model 3203 S-ICD Telemetry Wand may be used as an additional antenna to improve the Programmer's RF telemetry performance with transvenous pulse generators. If the wand is placed in a sterile field, it must be enclosed in a sterile Model 3320 Intraoperative Probe Cover during use. When the Model 3203 S-ICD Telemetry wand is not used for RF telemetry communication with transvenous PGs, be sure to disconnect the Model 3203 S-ICD Telemetry Wand from the Programmer to prevent transvenous PG telemetry dropouts.
- **Wi-Fi.** Wi-Fi connectivity is not permitted in Indonesia due to specific configuration requirements.

EMBLEM S-ICD Precautions

For precautions specific to programming the EMBLEM S-ICD pulse generator, refer to the *EMBLEM™ S-ICD Application Operator's Manual (Model 3877)*.

Maintenance and Handling

- **Cleaning the Programmer.** Do not use an abrasive cloth or volatile solvents to clean any portion of the device. See "Cleaning the Programmer and Accessories" on page 45 for recommended cleaning.
- **Magnet handling.** Do not place a magnet on the Programmer.
- **Presence of flammables.** The LATITUDE Programming System is not waterproof or explosion-proof and cannot be sterilized. Do not use it in the presence of flammable gas mixtures including anesthetics, oxygen, or nitrous oxide.
- **Disconnecting the Programmer.** To completely disconnect the Programmer from the power source, first press and release the power button  to turn the system off. Then disconnect the power cord from the side of the Programmer.
- **Programmer accessibility.** Ensure that the sides of the Programmer are accessible at all times so that the power adapter cord can be disconnected.
- **Lithium-ion battery.** The Model 6753 Lithium-ion battery contains highly flammable chemicals and should be handled with caution. Abuse of this battery can result in fire or explosion. Read the following prior to using this battery:
 - Do not expose the battery to temperatures above 140 °F (60 °C).

- Do not puncture the battery as it can lead to a fire or explosion. If the battery housing is punctured, or otherwise visibly damaged, do not attempt to use it.
- Do not strike the battery or otherwise subject it to strong impacts.
- Do not submerge the battery in any fluids.
- Do not connect the + and – terminals with wire or any conductive objects.
- Do not disassemble, modify, or repair the battery.
- Only use the Model 3300 Programmer to charge the battery. Use of any other battery charger can permanently damage the battery or even cause a fire or explosion.
- **System Power up.** Boston Scientific recommends attaching all necessary cables and devices before turning on the Model 3300 Programmer.

Radio Frequency (RF) Performance

To reduce emissions and improve RF performance, adhere to the following guidelines:

- Avoid establishing telemetry communication between the Programmer and the PG when the device is in close proximity to monitors, high-frequency electrosurgical equipment, or strong magnetic fields. The telemetry link (RF or inductive) may be impaired.
 - Do not loop any cables around or over the Programmer.
 - Cables on the physician side panel and patient side panel should be kept on their respective sides to minimize coupling.
 - Route cables directly away from the Programmer when possible.
 - When using the DisplayPort output to external video or a digital monitor:
 - Keep the external video or digital monitor and its cable routed away from the Programmer to avoid electrical interference.
 - Use high-quality shielded cables with integral conversions (e.g., DisplayPort to HDMI) when possible.
 - Minimize the use of active adapters other than those identified by Boston Scientific as they can create emissions that can interfere with PG telemetry.

Adverse Effects

The following list includes the possible adverse effects associated with programming pulse generators described in this manual.

- Asystole
- Atrial arrhythmia
- Bradycardia
- Tachycardia
- Ventricular arrhythmia

Any serious incident that occurs in relation to this device should be reported to Boston Scientific and the relevant local regulatory authority.

SYSTEM CAPABILITIES

The LATITUDE Programming System communicates with PGs and provides the following capabilities in hardware, interrogation/programming, patient data management, networking, and software:

Hardware

- Color touchscreen display with capacitive touch
- Internal solid-state drive
- Connections allow for a patient ECG cable and PSA cable to be input and displayed on the Programmer (certain applications only)
- DisplayPort for an optional external display
- USB ports (4) available for patient data export to a standard USB 2.0 or 3.0 pen drive, connection to an external printer, or used for software installation by Boston Scientific personnel

NOTE: *The USB ports are forward and backward compatible. USB 2.0 devices work in USB 3.0 ports and USB 3.0 devices work in USB 2.0 ports. The lowest version of USB determines the speed. For example, a USB 3.0 device plugged into a USB 2.0 port runs at 2.0 speed, and a USB 2.0 device plugged into a USB 3.0 port runs at 2.0 speed.*

Interrogation and Programming

- Interrogates and programs the implantable PG
- Displays records, stores patient data, and allows the physician to evaluate alternative prescription modes, generate reports, and record episodes
- Performs tests in an electrophysiology laboratory, in an operating room, in an emergency room, in clinical environments, or at a patient's bedside
- May be used to support diagnostic activities³ pertaining to implanting, programming, and monitoring Boston Scientific implantable PGs
- Provides a Pacing System Analyzer (PSA) application⁴ to assess electrical performance and placement of cardiac lead systems during implant of cardiac rhythm management devices
- Provides real-time electronic capture of various events from the PG and the PSA application
- Outputs surface ECG and telemetered signals (intracardiac electrograms and event markers) in PDF format
- Provides emergency access to STAT SHOCK, PG STAT PACE, PSA STAT PACE, and DIVERT THERAPY functionality applicable to the PG and PSA application

3. The LATITUDE Programming System is not intended for use as an ECG monitor or general diagnostic device.

4. Refer to the *Pacing System Analyzer (PSA) Operator's Manual* (Model 3922) for PSA setup and use information.

- Provides ZIP telemetry, a cordless, hands-free RF communication option that allows the Programmer to communicate with the PG

Patient Data Management

For transvenous PGs, the LATITUDE Programming System provides the ability to print, save, or transfer related data (via Bluetooth® or USB pen drive), during or after an implant/follow-up session, to a clinic computer for processing/transferring data to external systems (e.g., EMR systems).

Refer to the *Patient Data Management Operator's Manual (Model 3931)* for additional information.

NOTE: For S-ICD PGs, the S-ICD Application provides functions for patient data management. Refer to the *EMBLEM™ S-ICD Application Operator's Manual (Model 3877)* for additional details.

Networking

The LATITUDE Programming System provides Ethernet and wireless (Wi-Fi) connectivity for data transmission.⁵ Bluetooth® connectivity is available for data transfer (e.g., to a laptop) and printing.

Refer to the *Network and Connectivity Operator's Manual (Model 3924)* for additional networking and connectivity setup and use information.

Refer to the *EMBLEM™ S-ICD Application Operator's Manual (Model 3877)* for information about using Bluetooth® within the S-ICD application.

Heart Connect

Heart Connect is a data sharing application that can display and share physiological and/or other medical data from the LATITUDE Programming System. Heart Connect provides health care providers and Boston Scientific personnel with the means to establish an online meeting and share the video display from the Model 3300 Programmer with individuals in a remote location.

Refer to the *Heart Connect™ Operator's Manual (Model 3932)* for additional setup and use information.

Automated Screening Tool

The Model 3889 EMBLEM S-ICD Automated Screening Tool (AST) is software used on the Model 3300 LATITUDE Programming System to screen patients to assess them for implant of the EMBLEM Subcutaneous Implantable Cardioverter Defibrillation (S-ICD) system.

Refer to the *EMBLEM™ S-ICD Automated Screening Tool (AST) Instructions for Use (Model 3889)* for additional setup and use information.

Software

Software updates and downloads are provided via Internet or USB pen drive. If a software update or download does not complete successfully, you can re-initiate the update or download.

5. Wi-Fi connectivity is not permitted in Indonesia due to specific configuration requirements.

The Utilities tab on the Programmer screen includes a Software Update selection. The user may choose from downloading and installing all updates or reviewing and selecting updates from those available. See "Software Update Tab" on page 37.

ALTRUA™, INSIGNIA™ I, and NEXUS™ I Pulse Generator Support

The Model 3892 ALTRUA/INSIGNIA I/NEXUS I Support Application is available in eight languages: US English, UK English, French, Italian, Spanish, German, Dutch, and Swedish.

If a Model 3300 Programmer is configured to an unsupported language when the Model 3892 Support Application is started, the Model 3300 Programmer will default to English.

- Chinese and Japanese default to US English
- Portuguese and Brazilian Portuguese default to UK English

SYSTEM ACCESSORIES







The following accessories have been tested and can be used with the Model 3300 Programmer:

- Model 6395 Telemetry Wand⁶ (re-sterilizable)
- Model 3203 S-ICD Telemetry Wand⁷
- Model 3320 Intraoperative Probe Cover, sterile and disposable, may be required with the re-sterilizable Model 6395 Telemetry Wand and is required with the non-sterilizable Model 3203 S-ICD Telemetry Wand if the wand is located within the sterile field
- Model 6697 (Remington Model S-101-97) PSA Disposable Cable, single-use only
- Model 6763 PSA Cable, re-sterilizable and re-usable; the cable clip protective covers contain Elastosil R401 (silicone rubber)
- Model 6133 (Remington Model ADAP-2R) Safety Adapter
- Model 3154 Fixed Patient Leads ECG Cable; For Canada and China only, use the Model 3153 Fixed Patient Leads ECG Cable⁸
- Model 6629 ECG-BNC Cable
- Model 6689 Power Adapter (supply)
- Model 6753 Lithium-ion Battery, rechargeable and replaceable

The following AC power cords are also available for use with the Model 3300 Programmer:

AC Power Cord Model	Outlet
Model 6175 and Model 6286 AC Power Cord (Type B; e.g. Canada, Mexico, Japan)	

6. The Model 6395 Telemetry Wand does not include a magnet.
7. The Model 3203 S-ICD Telemetry Wand must be used to interrogate an S-ICD PG, and it may be used as an additional antenna to improve RF telemetry communication performance with some transvenous PGs.
8. The Model 3154 and 3153 Fixed Patient Leads ECG Cables contain current-limiting features to protect against defibrillation and should be the ECG cables used with the LATITUDE Programming System.

Model 6285 AC Power Cord (Type F; e.g. Europe)	
Model 6282 AC Power Cord (Type J; e.g. Switzerland)	
Model 6343 AC Power Cord (Type G; e.g. United Kingdom)	
Model 6289 AC Power Cord (Type N; e.g. Brazil)	
Model 6284 and Model 6287 AC Power Cord (Type I; e.g. Australia, China)	
Model 6283 AC Power Cord (Type M; e.g. South Africa)	

To order accessories, contact Boston Scientific using the information on the back cover of this manual.

WARNING: The use of any cables or accessories with the LATITUDE Programming System other than those provided by or specified by Boston Scientific could result in increased electromagnetic emissions, decreased electromagnetic immunity, or electrical shock of the LATITUDE Programming System. Anyone connecting such cables or accessories to the LATITUDE Programming System, including the use of MSOs (Multiple Socket Outlets), may be configuring a medical system and is responsible to ensure that the system complies with the requirements of IEC/EN 60601-1, Clause 16 for medical electrical systems.

Optional External Equipment

Optional external equipment can be used with the LATITUDE Programming System. Contact your Boston Scientific sales representative to determine what external equipment can be used.

NOTE: If adding external equipment, you are configuring a medical system and are responsible to ensure that the system complies with the requirements of IEC/EN 60601-1, Clause 16 for medical electrical systems.

NOTE: If adding a USB device, make sure it conforms with IEC/EN 60950-1 for information technology equipment.

WARNING: Do not simultaneously touch the patient and any accessible LATITUDE Programming System connector or exposed conductor.

CAUTION: Although optional external equipment connected to the Model 3300 Programmer must meet the applicable leakage-current requirements for commercial products, it may not meet the more stringent leakage requirements for medical products. Consequently, all external equipment must be kept outside the patient environment.

- Never touch the electrical contacts on the side panels of the Model 3300 Programmer and the patient, a telemetry wand, or any cable at the same time.

Stand

A stand (Model 6755) is available for the LATITUDE Programming System. It easily attaches to the bottom of the Programmer with a clip. It provides two convenient viewing angles and has a storage pocket in the back for storing cables and wands.

When the stand is used in the flat position, do not use downward force on the handle as the unit may tip.

To attach the stand, slip the stand under the Programmer and tilt the stand up to engage the clip as illustrated in Figure 1 Optional Stand for the LATITUDE Programming System on page 16.

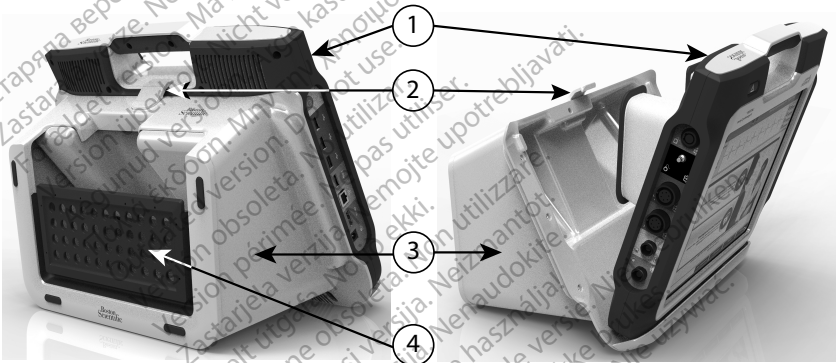

[1] Model 3300 Programmer [2] Stand Clip [3] Model 6755 Stand [4] storage pocket

Figure 1. Optional Stand for the LATITUDE Programming System

CAUTION: The power adapter normally gets warm when it is in use or charging. Do not place the power adapter in the storage pocket of the stand while it is in use or charging as the confined space will not allow the heat to dissipate adequately.

External Printer

The LATITUDE Programming System supports a broad range of external USB 2.0 and USB 3.0 printer drivers. Refer to "Connections" on page 17 to connect the printer's USB cable.

Some Bluetooth® printers are also supported. Refer to the *Network and Connectivity Operator's Manual (Model 3924)* for additional setup and use information.

USB Grounding Plug and Cable

A USB grounding plug and cable may be used with the Model 3300 Programmer to provide an earth ground to decrease noise interference to the LATITUDE Programming

System. Contact your hospital/clinic biomedical engineering department for this standard piece of equipment.

WARNING: The use of any cables or accessories with the LATITUDE Programming System other than those provided by or specified by Boston Scientific could result in increased electromagnetic emissions, decreased electromagnetic immunity, or electrical shock of the LATITUDE Programming System. Anyone connecting such cables or accessories to the LATITUDE Programming System, including the use of MSOs (Multiple Socket Outlets), may be configuring a medical system and is responsible to ensure that the system complies with the requirements of IEC/EN 60601-1, Clause 16 for medical electrical systems.

External Display

You can use an external monitor (or equivalent) that can synchronize to any horizontal scan frequency.

NOTE: *External monitors may require an adapter and/or cable to connect to the DisplayPort on the Programmer.*

NOTE: *Equipment connected to the external connections must comply with applicable standards for data processing equipment and for medical equipment.*

WARNING: The use of any cables or accessories with the LATITUDE Programming System other than those provided by or specified by Boston Scientific could result in increased electromagnetic emissions, decreased electromagnetic immunity, or electrical shock of the LATITUDE Programming System. Anyone connecting such cables or accessories to the LATITUDE Programming System, including the use of MSOs (Multiple Socket Outlets), may be configuring a medical system and is responsible to ensure that the system complies with the requirements of IEC/EN 60601-1, Clause 16 for medical electrical systems.

Cellular Adapter

NOTE: *Boston Scientific recommends attaching or removing the cellular adapter while the Model 3300 Programmer is powered Off.*

A cellular adapter is available for the LATITUDE Programming System to connect to a cellular network. It attaches to any available USB port on the left side of the Programmer. Refer to the *Network and Connectivity Operator's Manual (Model 3924)* for instructions and use.

CONNECTIONS

Refer to Figure 2 Right Side Panel of the Programmer on page 18 and Figure 3 Left Side Panel of the Programmer on page 18 to identify the port connections to the Programmer.

Patient Side Panel (Right Side)

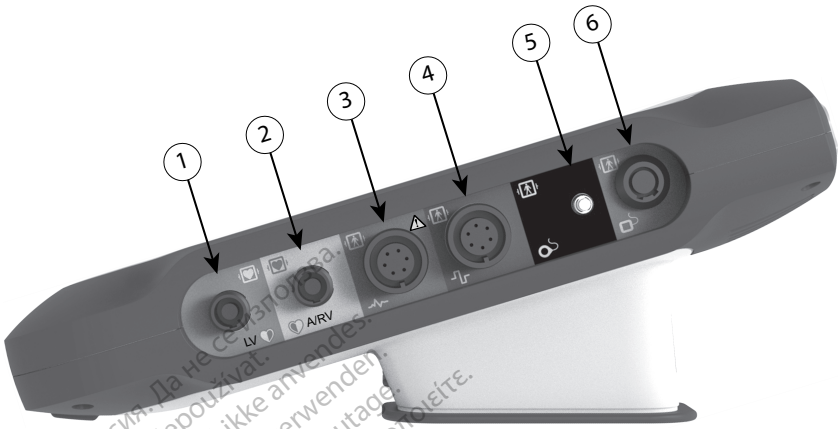

[1] Model 6763 PSA Cable for LV (green) [2] Model 6763 PSA Cable for A/RV (light gray) [3] Model 3154/3153 ECG Cable (dark gray) [4] connection port for future use (brown) [5] Model 3203 S-ICD Telemetry Wand (black) [6] Model 6395 Telemetry Wand (blue).

Figure 2. Right Side Panel of the Programmer

Physician Side Panel (Left Side)

NOTE: Equipment connected to the external connections must comply with applicable standards for data processing equipment and for medical equipment.

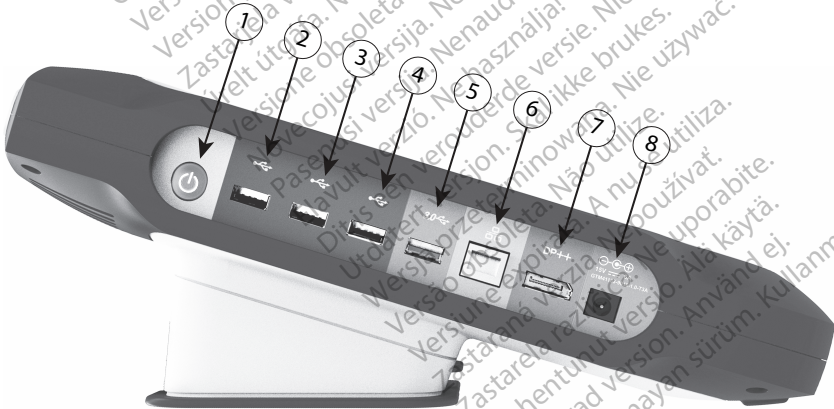

[1] Power (on/off) button (light gray) [2-4] USB 2.0 ports (dark gray) [5] USB 3.0 port (blue) [6] Ethernet port (orange) [7] DisplayPort Out (red-orange) [8] DC power connection for Model 6689 power adapter (green)

Figure 3. Left Side Panel of the Programmer

Indicator Lights

The Programmer has an indicator light on the left side of the device contained within the power (on/off) button . The Model 6395 Telemetry Wand has an indicator light on the front face. The functions are described below.

-  Power (on/off) button is lit when the Programmer is on.
- The light on the Model 6395 Telemetry Wand illuminates to indicate that inductive telemetry is established and is actively communicating to a PG.

STAT Button

The Programmer has a red STAT button  on the front top-right of the device. Depending on the situation, the STAT function provides STAT PACE, STAT SHOCK, or DIVERT THERAPY.

For transvenous PGs, see "STAT Button for Transvenous PGs" on page 28 for STAT button operation.

For S-ICD PGs, only STAT SHOCK can be delivered. See "STAT Button for S-ICD PGs" on page 30 for STAT button and Rescue Shock operation.



[1] Red STAT button

Figure 4. Front View of LATITUDE Programming System Indicating the Red STAT Button Location

USING THE LATITUDE PROGRAMMING SYSTEM

Preparation for Use

Battery Charge Level and Charging

The Lithium-ion battery for the Programmer is not charged when shipped. To charge the battery, perform the following steps.

NOTE: Before using the battery with the LATITUDE Programming System, ensure that the battery is fully charged.

1. Connect the AC power to the Programmer and leave the Programmer powered Off. See Figure 3 Left Side Panel of the Programmer on page 18.

2. Leave the Programmer Off for at least several minutes to allow Programmer battery charging to begin.
3. Turn On the Programmer. See Figure 3 Left Side Panel of the Programmer on page 18.
4. Check the battery charge by noting the battery status indicator in the upper left of the screen, which displays the battery charge percent. See Figure 9 Model 3300 Programmer Main Screen on page 26.
5. Nominally, battery charging can take 1-2 hours when the battery is less than 30% charged.

NOTE: *As long as the Programmer is plugged in (connected to AC power), the battery will charge. The Programmer does not have to be powered on to recharge the battery.*

Prepare a Telemetry Wand

Depending on the PG being used, prepare the appropriate wand.

Model 6395 Telemetry Wand

CAUTION: The Model 6395 Telemetry Wand is shipped non-sterile. Remove the wand from all packaging material before sterilizing it. If the wand is to be used in a sterile field, it must be actively sterilized before use or enclosed in a sterile Model 3320 Intraoperative Probe Cover during use. Refer to "Cleaning the Programmer and Accessories" on page 45 for sterilization and cleaning information.

If needed, prepare the Model 6395 Telemetry Wand for the sterile field by following the procedures in "Cleaning the Programmer and Accessories" on page 45 or by enclosing the wand in a sterile Model 3320 Intraoperative Probe Cover.

Model 3203 S-ICD Telemetry Wand

CAUTION: The Model 3203 S-ICD Telemetry Wand is shipped non-sterile. Remove the wand from all packaging material before use. If the wand is to be used in a sterile field, it must be enclosed in a sterile Model 3320 Intraoperative Probe Cover during use. Refer to "Cleaning the Programmer and Accessories" on page 45 for cleaning information.

To use the Model 3203 S-ICD Telemetry Wand as an additional antenna for RF telemetry, refer to "Prepare for Telemetry with a Transvenous PG" on page 23.

If needed, prepare the Model 3203 S-ICD Telemetry Wand for the sterile field by enclosing the wand in a sterile Model 3320 Intraoperative Probe Cover.

Cable Connections

For connector locations, refer to the panels on the Model 3300 Programmer System right side and left side (Figure 2 Right Side Panel of the Programmer on page 18 and Figure 3 Left Side Panel of the Programmer on page 18).

Make Patient Side Connections

As needed, make the following connections on the right side of the Programmer.

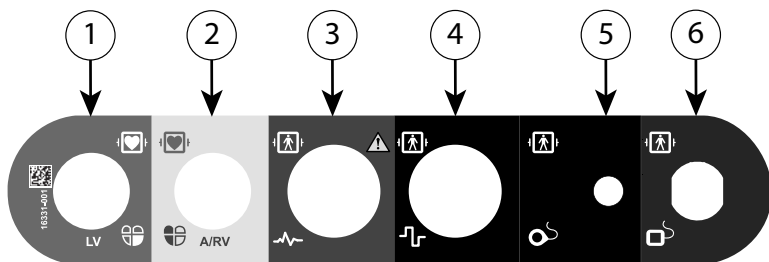

[1] Model 6763 PSA Cable for LV (green) [2] Model 6763 PSA Cable for A/RV (light gray) [3] Model 3154/3153 ECG Cable (dark gray) [4] connection port for future use (brown) [5] Model 3203 S-ICD Telemetry Wand (black) [6] Model 6395 Telemetry Wand (blue)

Figure 5. Right Side (Patient) Panel

1. For PSA measurements, connect the appropriate PSA cable to the appropriate connector (LV or A/RV).
2. Connect the appropriate telemetry wand to its connector:

- Model 6395 Telemetry Wand
- Model 3203 S-ICD Telemetry Wand

NOTE: Under battery-operated power with wanded telemetry, the LATITUDE Programming System is able to communicate with the PG beneath the patient's skin. For most pectoral implants, the telemetry is sufficient to communicate with the PG. For abdominal implants, the distance may be greater and battery-operated power only may not be sufficient to maintain reliable communication. To achieve maximum inductive telemetry communication with the PG, always use external power.

3. Connect the surface ECG patient cable to the ECG connector. Attach the surface electrodes to the patient in a standard three-wire or five-wire configuration.

NOTE: The ECG function may be sensitive to high-frequency ambient noise when the ECG inputs are not attached. If the electrodes are not attached to the patient, they may be sensitive to high-frequency environmental noise and therefore provide a poor signal. The ECG surface traces can be turned off if excessive noise is present.

NOTE: The ECG function is intended to be used during patient exams for tests such as pace threshold testing.

NOTE: The ECG function may exhibit noise interference if the LATITUDE Programming System is in close proximity to high-frequency electro-surgical equipment. For corrective action, refer to "Troubleshooting" on page 54.

4. If RF telemetry is insufficient, connect the Model 3203 S-ICD Telemetry Wand to its connector. The S-ICD telemetry wand acts as an extra RF antenna. Orient this wand as necessary to improve RF telemetry communication performance. Refer to "Steps to Improve ZIP (RF) Telemetry Performance" in "Prepare for Telemetry with a Transvenous PG" on page 23 for additional information.

Make Physician Side Connections

As needed, make the following connections on the left side of the LATITUDE Programming System.

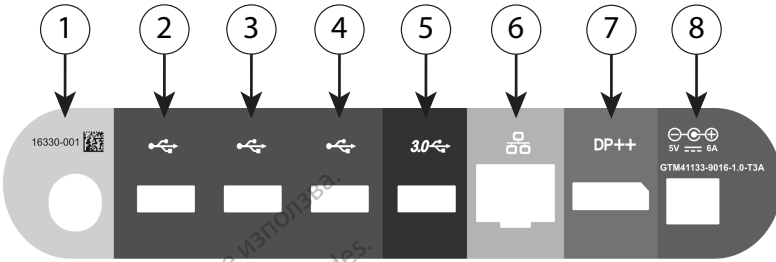

[1] Power (on/off) button (light gray) [2-4] USB 2.0 ports (dark gray) [5] USB 3.0 port (blue) [6] Ethernet port (orange) [7] DisplayPort out (red-orange) [8] DC power connection for Model 6689 Power Adapter (green)

Figure 6. Left Side (Physician) Panel

1. Connect the power cord to the DC receptacle on the left side panel of the Programmer.
2. To connect an external USB printer, attach the appropriate USB cable (2.0 or 3.0) to the appropriate USB port on the Programmer. Then, ensure that the printer is connected to external power.

NOTE: Connect the printer to the USB port, then wait 30 seconds for the system to recognize the printer before sending files to the printer.

NOTE: The LATITUDE Programming System has Bluetooth® capability, which can be used to connect with Bluetooth® capable printers. Refer to the Network and Connectivity Operator's Manual (Model 3924) for additional setup and use Information.

3. Use the DisplayPort Out connector to attach an external monitor. Then, ensure that the monitor is connected to external power.
4. To connect to a LAN, attach an Ethernet cable to the Ethernet port.

NOTE: Connect the Ethernet cable only to the RJ45 Ethernet port connector on the Model 3300 Programmer.

NOTE: Additional steps need to be completed when using Bluetooth® or LAN communications. Refer to the Network and Connectivity Operator's Manual (Model 3924) for additional information.

5. Ensure the power adapter cable is plugged into the DC port on the left side of the Programmer and the power cord is plugged into the power adapter.

NOTE: Ensure the left side of the device is accessible at all times so that the power cord can be connected or disconnected.

Electrosurgical Cables

Electrosurgical cables must be kept at least 30 cm (12 in) away from the LATITUDE Programming System to avoid false screen traces when electrosurgical energy is applied.

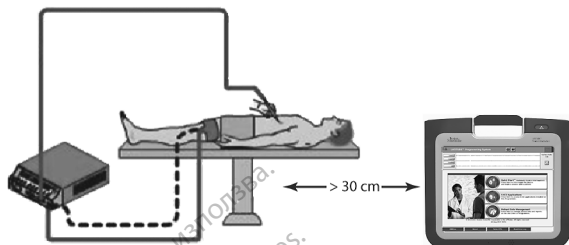

Figure 7. Electrosurgical Cables Distance from LATITUDE Programming System

Prepare for Telemetry with a Transvenous PG

Transvenous PGs⁹ can be interrogated using either ZIP telemetry or wanded telemetry.

ZIP Telemetry

NOTE: The ZIP telemetry feature is not available for all Boston Scientific PGs. For more information, refer to the associated product literature for the PG being interrogated.

For PGs that communicate using ZIP telemetry:

1. For optimum ZIP telemetry communication, position the LATITUDE Programming System within 3 m (10 ft) of the PG.
2. Remove obstructions between the LATITUDE Programming System and the PG.

NOTE: Reorienting or repositioning the LATITUDE Programming System may improve ZIP telemetry performance.

NOTE: The Model 3203 S-ICD Telemetry Wand may be used as a third RF antenna to improve RF telemetry performance.

NOTE: If ZIP telemetry performance is not successful, use the Model 6395 Telemetry Wand to interrogate the PG.

9. ALTRUA/INSIGNIA I/NEXUS I PGs use only wanded telemetry.



[1] Internal antenna locations, approximate

Figure 8. Front View of LATITUDE Programming System Indicating Approximate Antenna Locations Within the Enclosure

Steps to Improve ZIP (RF) Telemetry Performance

Perform the following to increase RF telemetry performance:

1. Disconnect all unused cables and wands and stow them.
2. All remaining connected patient side cables (PSA, ECG) should exit perpendicular to the Programmer and (as much as possible) directly toward the patient.
3. All remaining connected physician side cables (power, USB, DisplayPort, Ethernet) should be routed away from the patient.
4. If there are any electrical equipment (laptop, monitor, etc.) or metal objects adjacent to the Programmer, move them away from the Programmer as much as possible.
5. Move the Programmer closer to the patient, ideally away from a busy or crowded location in the room.
6. Change the Programmer orientation by rotating the Programmer up to 45 degrees clockwise or counter-clockwise or by placing the Programmer into the optional Model 6755 Stand.
7. Ensure that clinic staff are not in the line of sight between the Programmer and the implanted PG.
8. If ZIP telemetry is still not consistent, attach the Model 3203 S-ICD Telemetry Wand and place it within 0.6 m (2 ft) of the implanted PG. In the sterile field, use a Model 3320 Intraoperative Probe Cover and place the wand on top of the patient's stomach.
 - When not used for RF telemetry, be sure to disconnect the Model 3203 S-ICD Telemetry Wand from the Programmer to prevent telemetry dropouts.
9. If ZIP telemetry is not successful for a PG capable of RF telemetry, use the Model 6395 Telemetry Wand to interrogate the PG.

Wanded Telemetry

ALTRUA/INSIGNIA I/NEXUS I PGs must use the Model 6395 Telemetry Wand to interrogate the PG.

Startup

To turn on the LATITUDE Programming System:

1. Connect the power adapter cord to the DC receptacle on the left side panel of the LATITUDE Programming System (Figure 3 Left Side Panel of the Programmer on page 18).
2. Plug the AC power cord into the power adapter and an appropriate AC outlet.
3. Press the power button .

NOTE: It can take up to one minute for the Model 3300 Programmer to complete its self tests and display the startup screen. During this time, the screen may be flashing or blank.

4. Wait for the startup screen to appear.

NOTE: During system startup, observe the screen for any messages. If an error message appears, do not use the device, write a detailed description of the error, and contact Boston Scientific using the information on the back cover of this manual.

5. When startup is complete, the main screen displays (Figure 9 Model 3300 Programmer Main Screen on page 26), and the system is ready for use.

The Programmer's touchscreen allows you to select items such as buttons, check-boxes, and tabs that are displayed on the screen. Only one item can be selected at a time.

NOTE: The screen images in this manual are representative and may not exactly match your screens.

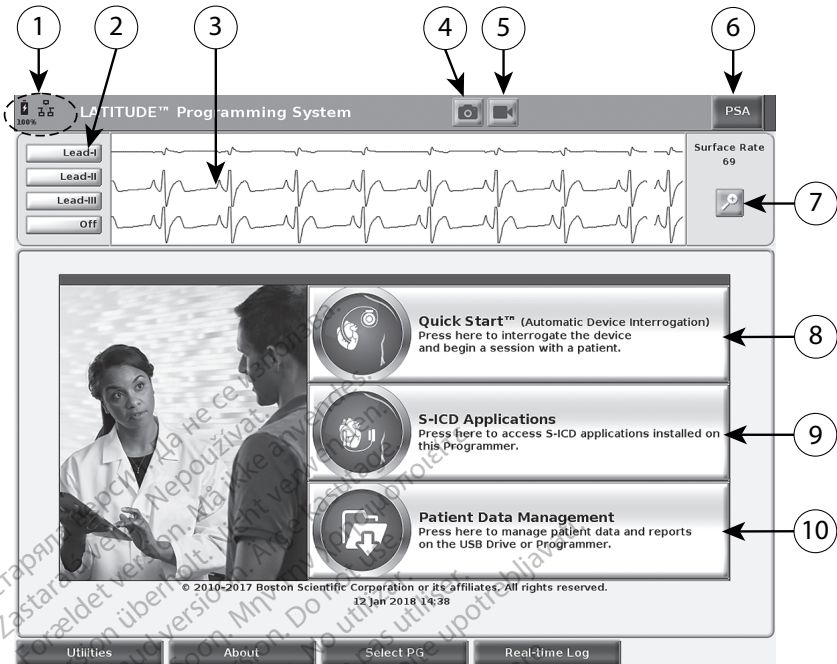

CAUTION: If you want to use a stylus, ensure that it is a projected capacitance stylus. The use of any other object could damage the touchscreen.





[1] Battery status, Ethernet, and Bluetooth® indicators [2] ECG and EGM lead trace selections, up to four [3] lead trace display area [4] Snapshot button [5] Real-time Recorder button [6] PSA application button [7] Magnify Traces button [8] Quick Start button [9] S-ICD Applications button [10] Patient Data Management button

Figure 9. Model 3300 Programmer Main Screen

When the LATITUDE Programming System is powered on, a Start Application window displays a progress bar as the software loads. Normally this takes up to one minute. When complete, the main screen displays the following as illustrated in Figure 9 Model 3300 Programmer Main Screen on page 26:

- The status area displays battery charge status and Wi-Fi, Ethernet, and Bluetooth® connectivity indicators
- The lead trace display, which can show up to four lead traces for patient assessment such as from a surface ECG or a PSA
- There are two buttons (Snapshot  and Real-time Recorder ) at the top of the screen for capturing real-time recordings of lead traces during ECG, PG, and PSA activity
- The PSA button activates the PSA application (see "Pacing System Analyzer (PSA)" on page 33)
- The Quick Start button  initiates PG communication to read a specific transvenous PG

- The S-ICD Applications button  opens the S-ICD Applications window (see "S-ICD Applications Button" on page 28)
- The Patient Data Management button  is used only with transvenous PGs and accesses patient data for export, printing, transfer, and deletion
- The Magnify Traces button  enlarges the lead trace area to fill the display window and provides additional information as illustrated in Figure 10 Magnify Traces Screen (During PG Session) on page 27

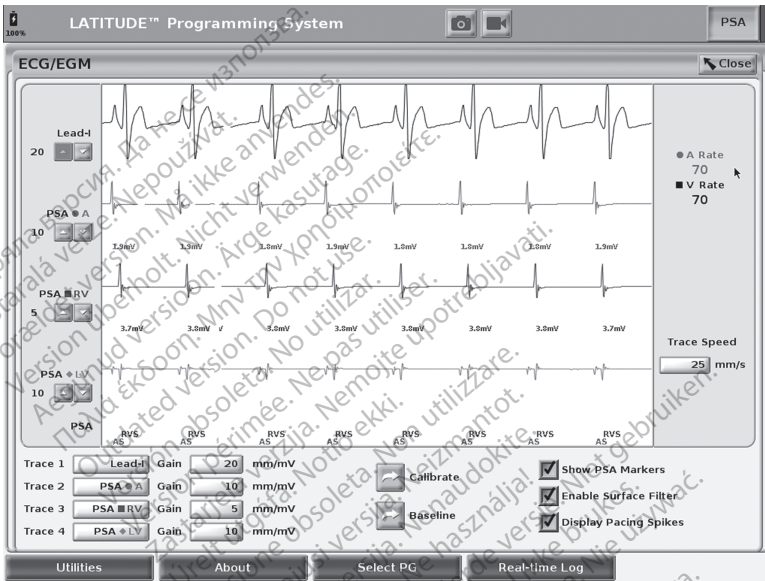

Figure 10. Magnify Traces Screen (During PG Session)

At the bottom of the screen are the following:

- The Utilities button, which allows access to LATITUDE Programming System information and setup functions the user may use prior to accessing the application software
- The About button, which allows the user to view, print, or save to a USB pen drive the LATITUDE Programming System configuration information (applications installed on the system and their associated version numbers)
- The Select PG button allows the desired transvenous PG application software to be selected and started, and includes the DEMO MODE option for some PG applications (see "Demo Mode" on page 35)
- The Real-time Log button, which is used only with transvenous PGs¹⁰ event recording, provides access to recording of various events from surface ECG and PSA

10. For S-ICD PGs, refer to the *EMBLEM™ S-ICD Application Operator's Manual (Model 3877)* for event recording.

- The date and time are located at the bottom-center area of the screen as shown in Figure 9 Model 3300 Programmer Main Screen on page 26 (see "Date and Time Tab" on page 36 for time zone setting)

PSA Button

The PSA button in the upper right of the startup screen switches the screen view and activates the PSA application. Refer to the *Pacing System Analyzer (PSA) Operator's Manual* (Model 3922) for details and instruction on using this application.

Quick Start Button

The Quick Start button on the main screen is used to automatically identify and interrogate the implanted transvenous PG. Refer to "Start a Transvenous PG Session" on page 30 for additional information.

S-ICD Applications Button

The S-ICD Applications button on the main screen opens the S-ICD Applications window. From this window, the S-ICD applications may be selected:

- The EMBLEM S-ICD Automated Screening Tool button opens the AST application. The AST application is used to screen patients to assess them for implant of the EMBLEM S-ICD system. Refer to the *EMBLEM™ S-ICD Automated Screening Tool (AST) Instructions for Use* (Model 3889) for details and instructions on using this application.
- The EMBLEM S-ICD Device Programmer Application button opens the S-ICD programming application. This application is used to program the EMBLEM S-ICD system. Refer to the *EMBLEM™ [S-ICD Application Operator's Manual* (Model 3877) for details and instructions on using this application.

Patient Data Management Button

The Patient Data Management application is used only with transvenous pulse generators and allows you to export, transfer, print, read, and delete patient data, which has been saved to the Programmer internal drive or USB pen drive. Refer to the *Patient Data Management Operator's Manual* (Model 3931) for details and instruction on using this application.

NOTE: For S-ICD pulse generators, the S-ICD Programmer Application provides functions for patient data management. Refer to the *EMBLEM™ S-ICD Application Operator's Manual* (Model 3877) for additional details.

STAT Button for Transvenous PGs

The STAT button  is at the top-right of the Model 3300 Programmer.

The following actions occur when the STAT button is pressed:

- When the PG is in storage, off, or monitor only mode, STAT SHOCK or PG STAT PACE is delivered. If the STAT SHOCK or PG STAT PACE is delivered in storage, the tachy mode changes to off.
- When in telemetry communication with a high-voltage (ICD or CRT-D) PG, a pop-up displays allowing the user to initiate a PG STAT PACE, STAT SHOCK, or DIVERT THERAPY command. If a PSA session is in progress, a PSA STAT PACE option also displays.

- When in telemetry communication with a low-voltage PG, a pop-up displays allowing the user to initiate a PG STAT PACE or DIVERT THERAPY command. If a PSA session is in progress, a PSA STAT PACE option also displays as shown in Figure 11 STAT Button Pop-up in a High-voltage PG Session with the PSA Application Running on page 29.
- When not in communication with a PG, an Interrogate button displays with text prompting the user to perform Quick Start to attempt to identify the device (see Figure 12 PSA STAT PACE Button Pop-up Outside Any PG session with the PSA Application Running on page 30). Once in a session with an implanted transvenous device, press the red STAT button again to display available options.
- PG STAT PACE - initiates PG STAT PACE functionality for any supported transvenous device (ICD, CRT-D, Pacemaker/CRT-P).
- STAT SHOCK - initiates PG STAT SHOCK functionality for supported high-voltage transvenous ICD and CRT-D PGs.
- DIVERT THERAPY - initiates PG DIVERT THERAPY for any supported transvenous device (ICD, CRT-D, Pacemaker/CRT-P) and, while in a PG session, stops the pending therapy.
- PSA STAT PACE - when a PSA session has been enabled, it configures the PSA with STAT PACE settings and functionality.

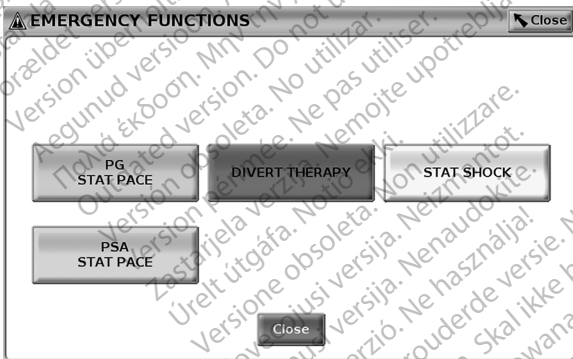

Figure 11. STAT Button Pop-up in a High-voltage PG Session with the PSA Application Running

The top row buttons (PG STAT PACE, DIVERT THERAPY, and STAT SHOCK) display during a PG session.

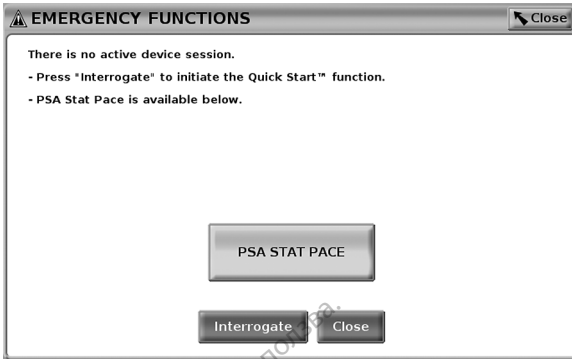



Figure 12. PSA STAT PACE Button Pop-up Outside Any PG session with the PSA Application Running

If not in a PG session, the STAT button brings up the following dialog with no buttons: "There is no active device session. Press "Interrogate" to initiate the Quick Start™ function."

If in a PSA session only (no PG interrogated), then the same dialogue displays along with the PSA STAT PACE button (see Figure 12 PSA STAT PACE Button Pop-up Outside Any PG session with the PSA Application Running on page 30).

STAT Button for S-ICD PGs

The STAT button is at the top right of the Model 3300 Programmer. During an S-ICD programming session, pressing either the STAT button  on the Programmer or the Rescue Shock icon  on the S-ICD screen, the following actions occur:

1. When in telemetry communication with an S-ICD pulse generator, a pop-up displays allowing the user to initiate a STAT SHOCK.
2. Select the Shock button to begin charging the pulse generator for a Rescue shock.
3. A red background screen with the word "Charging" displays and a loud, rising tone alarm sounds for the entire time the S-ICD is charging.
4. A confirmation screen displays with notification that the shock was delivered successfully along with the corresponding shock impedance.

NOTE: Anytime during charging, selecting the Cancel button from the Rescue Shock screen prevents delivery of a rescue shock and returns to the previous screen.

If for any reason the shock could not be delivered, a red background screen displays with a message stating "The shock could not be delivered."

For additional information about delivering a STAT Shock or Rescue Shock with an S-ICD PG, refer to the *EMBLEM™ S-ICD Application Operator's Manual (Model 3877)*.

Start a Transvenous PG Session

A transvenous PG session can be started two ways:

1. Use the Quick Start button to automatically identify the PG that is connected to the system.

2. Use the Select PG button to manually choose which application to start a session with the PG device.

Quick Start (Button)

1. Place the Model 6395 Telemetry Wand over the PG, and select the Quick Start button.
2. A message window displays, indicating one of the following conditions, based on the implanted PG:
 - Application startup in progress – If the software for the implanted PG is installed on the LATITUDE Programming System, it will identify the PG, start the correct application, and automatically interrogate the PG.
 - PG not identified – If a non-Boston Scientific PG or a Boston Scientific PG for which there is no application loaded on this Programmer is interrogated, a message window displays indicating that the PG is not identified¹¹.
 - Out-of-range and noise messages display to notify the user that the wand is out of range or telemetry noise is present.
3. To proceed with the interrogation session, refer to the associated product literature for the PG being interrogated.

Select PG (Button)

Use the Select PG button at the bottom of the screen to manually interrogate a transvenous PG.

1. Place the Model 6395 Telemetry Wand over the PG, and click the Select PG button on the startup screen.
2. Select the icon that represents the desired PG family.
3. Click the Interrogate button on the pop-up window.
4. To proceed with the interrogation session, refer to the associated product literature for the PG being interrogated.

For more information about the Quick Start and Select PG options, refer to the associated product literature for the PG being interrogated.

NOTE: The Select PG button also allows you to access DEMO MODE. See "Demo Mode" on page 35.

Start an S-ICD PG Session

The S-ICD application of the Model 3300 Programmer is used to interrogate and program an S-ICD pulse generator.

To start the S-ICD application, perform the following:

1. Select the S-ICD Applications button on the Programmer main screen to display the S-ICD Applications panel.
 2. Select the S-ICD Device Programmer Application button to load the S-ICD Application on the Programmer.
-
11. Some older Boston Scientific PGs require the use of the ZOOM™ LATITUDE™ Programmer/Recorder/Monitor (PRM), Model 3120 for programming. For questions, contact Boston Scientific using the information on the back cover of this manual.

NOTE: It can take approximately 30 seconds for the S-ICD Application to load. During this time, the screen displays the Start Application message and hourglass icon followed by a large text display of Boston Scientific.

3. When the S-ICD Programmer Application loads, the S-ICD main screen displays.
4. Refer to the *EMBLEM™ S-ICD Operator's Manual (Model 3877)* to configure and program the S-ICD pulse generator and to save and export S-ICD patient data.

Surface ECG

To run a surface ECG:

1. Connect the Model 3154 ECG cable¹² to the Model 3300 Programmer.
2. Connect the cable to the electrodes attached to the patient.
3. As needed, use the Snapshot and Real-time Recorder buttons to record ECG trace information.

The ECG or PSA traces will display on the main screen. Refer to Figure 9 Model 3300 Programmer Main Screen on page 26 for additional main screen information.

ECG Display

When the ECG patient cable is connected to the patient and the Programmer, the ECG display shows surface ECG signals without PG interrogation.

If ECG information is desired to be reviewed or saved, use the Snapshot or Real-time Recorder buttons to create a real-time log.

NOTE: The LATITUDE Programming System can display four surface traces of up to six limb leads or one chest lead. The top displayed lead will be annotated with the pacing spike marker if that feature is selected. To display the pacing spike markers correctly, the electrodes connected to the Lead-II display trace must be connected to the patient regardless of which lead is displayed. The Surface Rate will display the ventricular rate.

NOTE: The ECG functionality of the LATITUDE Programming System is intended to support diagnostic activities pertaining to implanting, programming, and monitoring Boston Scientific implantable PGs. The LATITUDE Programming System is not intended for use as an ECG monitor or general diagnostic device.

NOTE: Refer to the *EMBLEM™ S-ICD Application Operator's Manual (Model 3877)* for information about real-time display options.

WARNING: Operation of the LATITUDE Programming System with physiological signals that are lower than the minimum detectable amplitude may cause inaccurate results.

ECG Full Screen Display

To expand the ECG display to a full screen, select the Magnify Traces button  on the right side of the trace display area, then use the following screen buttons to change the values and appearance of the traces (see Figure 10 Magnify Traces Screen (During PG Session) on page 27):

- Trace Speed – Select the desired speed on the ECG display: 0 (stop), 25, 50, 100, or 200 mm/s

12. For Canada and China use the Model 3153 ECG Cable.

- Trace 1, Trace 2, Trace 3, and Trace 4 – Select the lead traces to be displayed
- Gain – Select the appropriate value to adjust the surface gain of the traces that are captured on printouts
- Calibrate button – Transmits a 1 mV calibration pulse so the user has a reference point to evaluate amplitudes
- Baseline button – Forces the trace back to the baseline and is normally used after a defibrillation shock
- Enable Surface Filter – Select the check box to minimize noise on the surface ECG
- Display Pacing Spikes – Select the check box to show detected pacing spikes, annotated by a marker on the top waveform
- Show PG Markers – When in a PSA application session, select the check box to enable the PG markers.

NOTE: The values as set up on the startup screen will be the defaults used for the application traces. The corresponding values can be changed from the trace selections screen while in the application. For detailed application programming instructions, refer to the associated product literature for the PG being interrogated.

Intracardiac Electrogram

Intracardiac electrograms may be displayed on the Programmer screen. Intracardiac electrograms and event markers can be captured and printed using the Real-time Log feature. For detailed instructions, refer to the associated product literature for the PG being interrogated.

NOTE: Refer to the *EMBLEM™ S-ICD Application Operator's Manual (Model 3877)* for information about intracardiac electrogram display options.

Pacing System Analyzer (PSA)

The PSA application is used to assess electrical performance and placement of cardiac lead systems during implant of cardiac rhythm management devices. The PSA application displays real-time EGM traces and event markers for each enabled channel. Real-time EGMs display on the same screen as the surface ECG, which includes a heart-rate indicator.

Refer to the *Pacing System Analyzer (PSA) Operator's Manual (Model 3922)* for additional information on how to use the PSA application of the LATITUDE Programming System, Model 3300.

Patient Data Management Utility

For transvenous PGs, the Patient Data Management application provides the ability to generate reports, and print, save, or transfer related data. The printable reports detail PG functions, stored patient data, and test results. Stored patient session data can be recalled later in the patient session for analysis (for certain applications only) and saved to the Model 3300 Programmer internal drive and/or saved to a removable USB pen drive and optionally encrypted. Refer to the *Patient Data Management Operator's Manual (Model 3931)* for additional information on the use of this application with transvenous PGs.

For S-ICD PGs, the S-ICD Device Programmer Application provides functions for viewing, printing, and exporting patient data. Refer to the *EMBLEM™ S-ICD Application Operator's Manual (Model 3877)* for these features.

Parameter Changes, Data Entry, Demo Mode, and Utilities

Changing Parameter Values

The screens for many of the features contain parameter information that can be changed via either a palette window or a keyboard window.



Figure 13. Palette Window - Parameter Selection Example

Palette Window

To change a parameter value, first select the appropriate parameter's value box. A palette window will appear. Select a value from the palette window by touching the desired value; the window will automatically close when a selection is made. To close a window without making a selection, touch the screen outside the window.

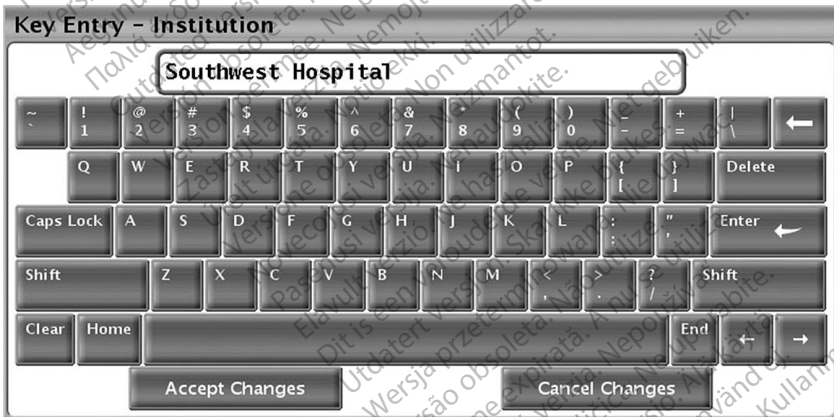

Figure 14. Keyboard Window Example

Keyboard Window

Some screens display value boxes that require unique data to be entered, typically from a keyboard window. To enter data from a keyboard window, first select the appropriate value box. A keyboard window will appear. Touch the first character of the new value; it will appear in the data-entry box in the graphic keyboard. Continue until the entire new value appears in the box. To delete one character at a time, starting with the last character, select the left arrow key on the graphic keyboard. Each time the left arrow key is selected, a character will be deleted in the box. To cancel any deletions or additions just made,

select the Cancel Changes button on the graphic keyboard. When all the appropriate characters have been selected, select the Accept Changes button on the graphic keyboard.

NOTE: If, when the keyboard window initially appears, it contains data in the data-entry box, select the Clear button on the graphic keyboard to delete all the characters in the data-entry box.

Demo Mode

Demonstration (Demo) mode is available for some transvenous PGs. To access the Demo mode, click on the Select PG button at the bottom of the screen, identify the device/family by clicking its icon, then click the Demo button on the SELECT PG MODE pop-up.

NOTE: Demo mode is not available for the Model 3892 ALTRUA/INSIGNIA I/NEXUS I Support Application.

NOTE: Demo mode is not available for the S-ICD Device Programmer Application.

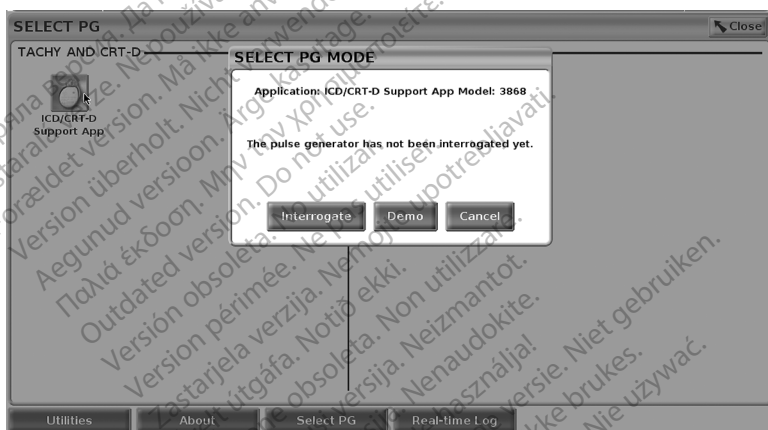

Figure 15. SELECT PG MODE (Demo) Pop-up (ICD/CRT-D Selected)

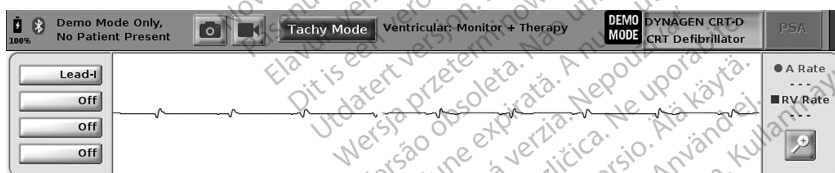

Figure 16. PG Demo Mode

The main application screen displays with the demo mode message and DEMO MODE logo at the top of the screen as illustrated in Figure 16 PG Demo Mode on page 35. The software application screens displayed during the demo mode reflect the features and programmable values of the PG family selected.

To exit the demonstration mode, select the End Session button in the lower right corner of the screen.

Utilities Button

Before accessing the PG software application, you can select the Utilities button to perform the following actions described in this section.

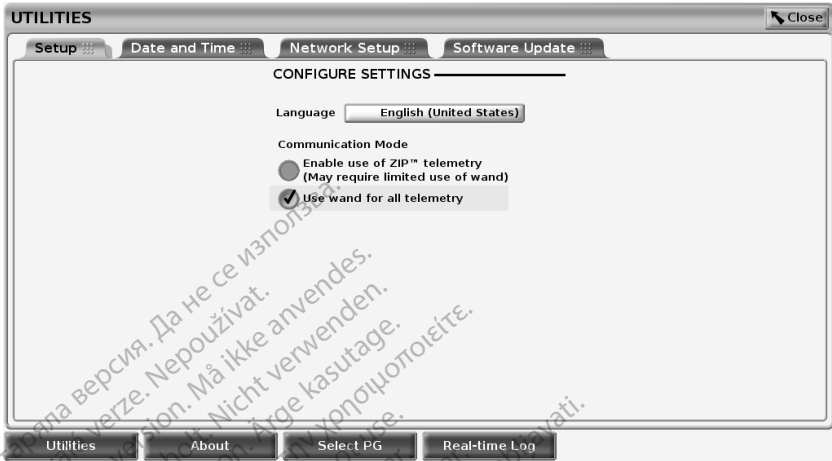

Figure 17. Utilities

The Utilities screen displays four tabs – Setup, Date and Time, Network Setup, and Software Update.

Setup - Configure Settings

The Setup tab (see Figure 17 Utilities on page 36) allows you to:

- Change the language displayed.
- Set the Communication Mode¹³ to enable Model 6395 wanded telemetry or ZIP telemetry for transvenous PGs (if it is approved for use in your geography).
- As indicated in Figure 17 Utilities on page 36, ZIP telemetry may not be enabled (the button is grayed out). If needed, contact Boston Scientific using the information on the back cover of this manual to have a representative enable ZIP telemetry.

Date and Time Tab

The Date and Time tab is used to select the TIME ZONE for the Programmer. The date and time display at the bottom of the main screen.

13. S-ICD PGs do not use this Communication Mode setup.



Figure 18. Utilities – Date and Time

NOTE: The LATITUDE Programming System clock synchronizes automatically when connected to a network. If there is no network connection, then the Boston Scientific representative can set the Programmer internal clock using a special USB key.

NOTE: If a pop-up displays asking to synchronize the clocks, follow the prompts to synchronize them.

NOTE: The S-ICD Device Programmer application will initially use the time and date of the 3300 Programmer. Once an S-ICD PG is interrogated, the S-ICD application uses the S-ICD PG's clock which cannot be changed. The S-ICD PG clock is factory set.

Network Setup Tab

The Network Setup tab provides connectivity to networks and devices via Wi-Fi, Bluetooth®, and Ethernet. Refer to the *Network and Connectivity Operator's Manual (Model 3924)* for additional network configuration and setup information.

NOTE: For S-ICD programming, patient data may be exported using Bluetooth®. However, Bluetooth® must be enabled on the Network Setup tab. Refer to the *EMBLEM™ S-ICD Application Operator's Manual (Model 3877)* for exporting S-ICD patient data.

Software Update Tab

The Software Update tab allows you to install software updates. The user may choose from downloading and installing all updates or reviewing and selecting updates from those available.

Updates are delivered online via the Internet. In addition, updates may be supplied on USB pen drives. Contact your local Boston Scientific representative using the information on the back cover of this manual for additional details concerning software updates on a USB pen drive.

Online Updates

From the Utilities screen, select the Software Update tab, which displays two buttons:

- Easy Install—directly begins downloading all available and qualified update packages. Once complete, the Programmer automatically restarts in install mode, completes the update, and returns to normal operation.
- Custom Install—displays the available and qualified update packages for user review/selection. Once the user completes the selection(s), they can proceed with the update and installation process.

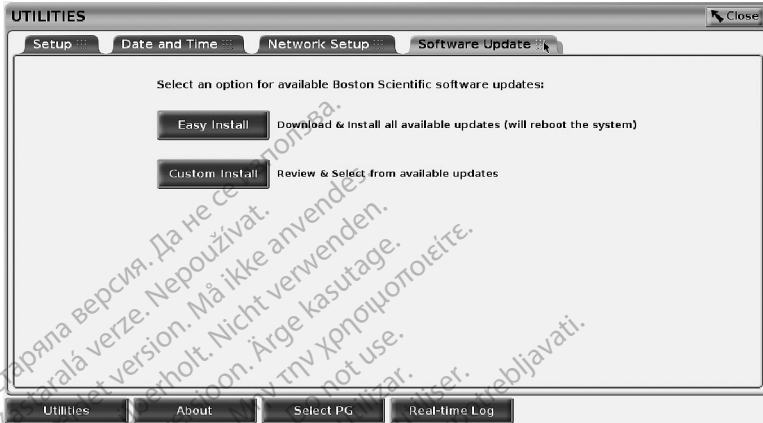

Figure 19. Utilities - Software Update

NOTE: *Mandatory updates must be installed and cannot be unselected.*

Boston Scientific is automatically informed when the software update has been successfully downloaded.

If the download is not successful, retry the download before contacting Boston Scientific for assistance.

Once downloading completes successfully, the Programmer restarts in install mode and displays the list of qualified Update Packages. Click on the Install button to begin installation.

When installation is complete, the programmer will restart (reboot).

NOTE: *Allow the Programmer to fully restart because an update confirmation will be sent via the network to Boston Scientific indicating a successful software install.*

Offline Updates

The Programmer can be updated via a special Software Install¹⁴ USB pen drive. When the software installation completes an offline update, power the Programmer off and back on to complete the process.

NOTE: *Allow the Programmer to fully restart because an update confirmation will be sent via the network to Boston Scientific indicating a successful software install.*

14. Software Install via USB pen drive is available only by your Boston Scientific representative.

About Button

Select the About button to display the About screen.

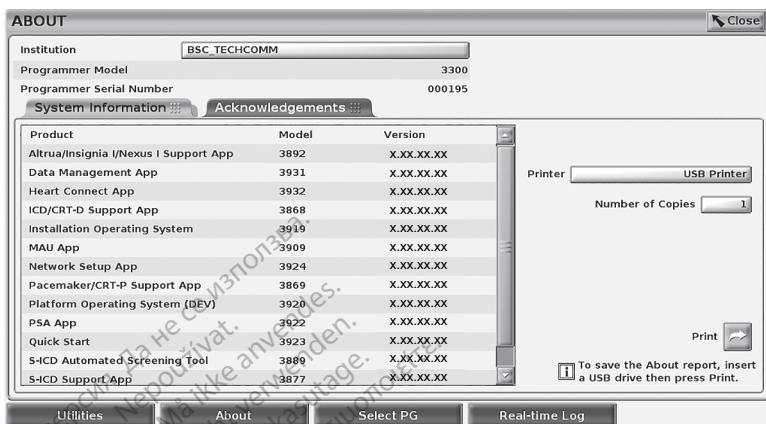

Figure 20. About Screen

Use the About screen to perform the following actions:

- Change the name of the institution: Select the value box next to Institution. Refer to detailed instructions for entering new data using the keyboard window (Figure 14 Keyboard Window Example on page 34).
- View the LATITUDE Programming System model and serial number information.
- Select the System Information tab and view the LATITUDE Programming System information including the version numbers of the system software and the installed software applications.
- Print the LATITUDE Programming System information (known as the About report).
 - From the About screen (see Figure 20 About Screen on page 39) select a printer (USB or Bluetooth®), number of copies, and then select the Print button.

NOTE: The printer (USB or Bluetooth®) selected in the Patient Data Management application (Model 3931) is the printer that displays in the About screen.

NOTE: If no printer is available, the About report can still be saved to an attached USB pen drive by pressing the Print button.

NOTE: If a USB pen drive is inserted in the Model 3300 Programmer when the About report is created, the report is converted to a PDF and saved to the USB pen drive.

Selecting a Transvenous PG

To select a transvenous PG, first select the Select PG button, shown at the bottom of Figure 20 About Screen on page 39, to display the SELECT PG screen.

NOTE: For S-ICD pulse generators, use the S-ICD Applications button from the main menu to start the S-ICD Application which interrogates an S-ICD PG.

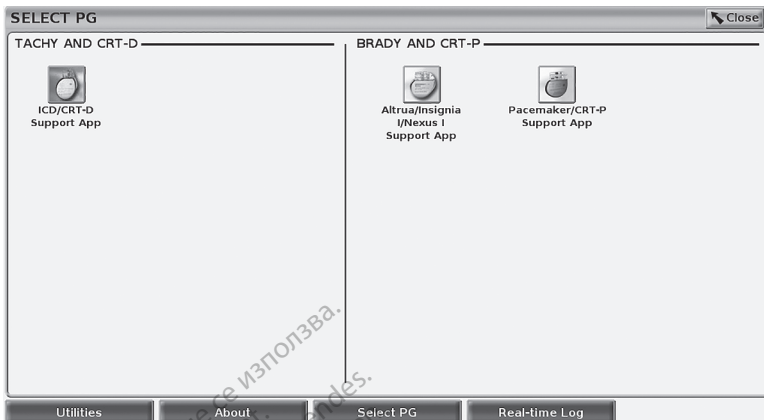

Figure 21. SELECT PG Screen

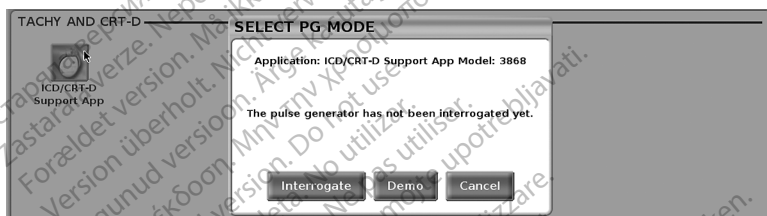

Figure 22. SELECT PG MODE

Select the device icon button (Figure 21 SELECT PG Screen on page 40), then select the Interrogate button in the message pop-up as illustrated in Figure 22 SELECT PG MODE on page 40.

Once Interrogated, the application loads, checks system status, and then displays the Summary screen (Figure 23 Summary Screen on page 41) for the chosen device therapy.

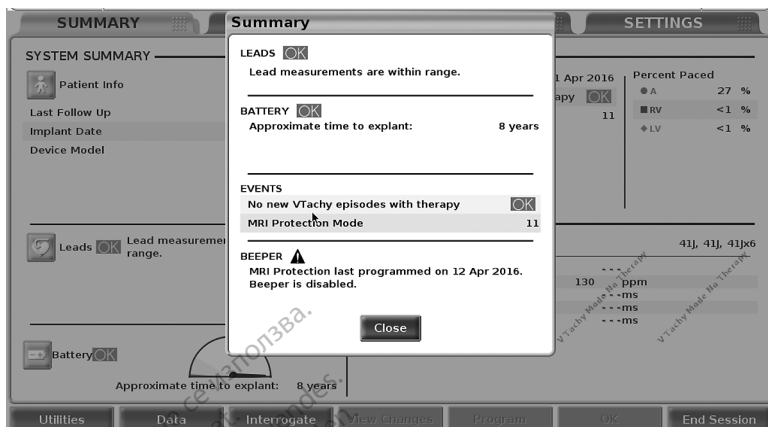

Figure 23. Summary Screen

NOTE: Not all PGs are MRI safe. The screen images in this manual are representative and may not exactly match your screens.



If the PG device is not found, a device not supported message displays and allows you to end the session.

Real-time Log for Transvenous PGs

The LATITUDE Programming System provides recording of various real-time ECG and EGM events from a transvenous PG and PSA.

NOTE: To record S-ICD PG events, refer to the EMBLEM™ S-ICD Application Operator's Manual (Model 3877).

Two buttons on the header bar of the screen are used for real-time recording of lead traces and PSA activity.

- The Snapshot button  – records up to 12 seconds per button press (10 seconds after and 2 seconds before). Press once to start and again to stop.
- Real-time Log – the Real-time Recorder button  records continuously upon button press, and stores data in 3-minute segments until a second press ceases recording. While recording is in progress, the icon blinks to reflect that storage is ongoing.
- Up to 100 individual recordings can be maintained during a session. In the event more than 100 are captured, the oldest will be deleted to accommodate newer. A Real-time Log is not retained from session to session; if not saved as a PDF or printed, it is deleted upon ending the current device session or starting a new device session.

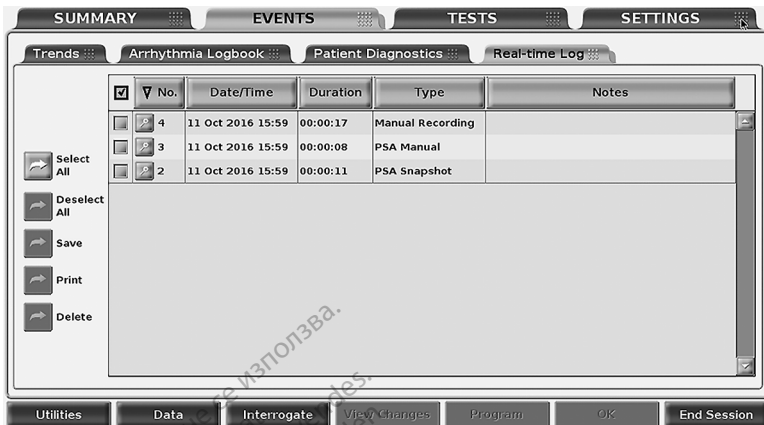

Figure 24. Real-time Log - List Screen



[1] Notes area [2] Real-time Log Tools pop-up [3] Electronic Calipers (slide bar) to adjust time span of event [4] Real-time Log Event display [5] Gain buttons [6] Scan speed adjustment





Figure 25. Real-time Log - Event Trace Example

The Notes button in the Notes area can be used to add comments. A Real-time Log can be customized using the tools in the Real-time Log Tools pop-up. The Electronic Calipers at the bottom of the screen can be adjusted to measure the desired time span.

Real-time Log Tools

Select any part of the Real-time Log Event display, and the Tools pop-up displays as in Figure 25 Real-time Log – Event Trace Example on page 42. At the top center of the pop-up is an arrow and a target icon. When a tool is selected, the tool action occurs at that target point on the screen. A new Tools pop-up displays each time you select another part of the Real-time Log Event display, so that you can use multiple tools anywhere on the display.

The five tools are:

- Circle tool  – places a circle on the display at the target point.
- Line tool  – places a dashed vertical line on the display at the target point.
- Left scissor tool  – removes the left-hand portion of the display from the target point.
- Right scissor tool  – removes the right-hand portion of the display from the target point.

NOTE: When using the scissors tools, the original trace is still available in the Real-time Log.

- Annotation tool  – displays a keyboard to type in any notes, which then appear on the trace.

Electronic Calipers

Use the Electronic Calipers (slide bar) to adjust the time span of the Snapshot trace. The time interval between the calipers is measured in seconds. A caliper can be repositioned by selecting it and then dragging it to expand or collapse the time frame. For detailed instructions on using the Electronic Calipers, refer to the associated product literature for the PG being interrogated.

Real-time Log Events

PG events that qualify for automatic real-time recording are listed in Table 1-PG Events on page 43. The device action that initiates storage is recorded in the Real-time Log.

Table 1. PG Events

Event Type	Trigger Event	Duration of Recording (seconds)
Presenting	Initial Interrogation Completed	12
Electrocautery Mode	Electrocautery Mode Entered	12
PG STAT PACE	PG STAT PACE Commanded	12
DIVERT THERAPY	DIVERT THERAPY Commanded	12

Table 1. PG Events (continued)

Event Type	Trigger Event	Duration of Recording (seconds)
PACE THRESHOLD TEST (AUTO, A, V, RV, LV, Ampl, and PW)	Threshold Test Ended	12
INTRINSIC AMPL TEST (A, V, RV, and SSI)	Intrinsic Ampl Test Completed	12
TEMP BRADY	Temp Start Entered, Temp End Entered	Temp Start to Temp End
STAT SHOCK	STAT SHOCK Commanded	48
Commanded V ATP	ATP Commanded	12
Commanded V Shock	Shock Commanded	12
Fib Induction High	Fib Induction Commanded	24
Fib Induction Low	Fib Induction Commanded	24
Shock on T Command	Shock on T Commanded	43
Ventricular PES	PES Commanded	24
Atrial PES	PES Commanded	24
PG Ventricular Burst Pacing	PG Burst Completed	24
PG Atrial Burst Pacing	PG Burst Completed	24
PG Ventricular 50 Hz Burst Pacing	PG Burst Completed	24
PG Atrial 50 Hz Burst Pacing	PG Burst Completed	24
PG Fault	PG Fault Occurred	12

PSA events are automatically labeled and stored. These event types are listed in Table 2 PSA Events on page 44.

Table 2. PSA Events

Event Type	Trigger Event	Duration of Recording (seconds)
PSA PACE THRESHOLD TEST (A, RV, and LV)	PSA Save Threshold button pressed	12
PSA BURST PACING	PSA Burst button released	24

MAINTENANCE

Cleaning the Programmer and Accessories

In addition to turning off the Model 3300 Programmer and disconnecting the power cord, Boston Scientific recommends removing the battery in the Programmer before cleaning. See "Battery Status, Installation, Replacement, and Recycling" on page 47 for instructions on removing the battery.

Clean the enclosure and touchscreen of the Programmer with a soft cloth lightly dampened with water, isopropyl alcohol, or mild detergent.

- DO NOT use a hand disinfectant solution on the Programmer or the display screen.
- DO NOT allow cleaning solution or moisture to come in contact with any port on the sides of the Programmer.
- DO NOT allow cleaning solution or moisture to come in contact with the speaker or microphone openings on the bottom front of the Programmer.



Figure 26. Microphone and Speaker Openings

The cables and the wands used with the LATITUDE Programming System are not sterile when packaged. Only the Model 6763 PSA cable and the Model 6395 Telemetry Wand can be sterilized. All other cables and the Model 3203 S-ICD Telemetry Wand cannot be sterilized, but they can be cleaned.

WARNING: Before cleaning and disinfecting the Programmer surfaces, power down the device and disconnect the external power supply. Before operating the LATITUDE Programming System, let cleaning and disinfection agents used on the Programmer evaporate.

CAUTION: Do not use an abrasive cloth or volatile solvents to clean any portion of the device. See "Cleaning the Programmer and Accessories" on page 45 for recommended cleaning.

Cleaning Cables and Wands

At point of use:

When necessary, to prevent drying of any possible contaminants immediately after use, clean the cable or wand with a soft cloth dampened with sterile water.

Thorough Cleaning:

Thoroughly clean the cable or wand with a soft cloth dampened with a mild cleaning solution such as green soap, green soap tincture (U.S. Pharmacopeia), sodium tetraborate decahydrate (such as Borax or equivalent), or alcohol-free hand soap. Prepare and use the cleaning agent per detergent manufacturer's instructions. Use a fresh soft cloth dampened with sterile water to remove residue. Towel-dry or air-dry the cable. Visually inspect the cable to ensure contaminants are removed. Repeat the cleaning step until all visible contaminants are removed.

- DO NOT use an ultrasonic cleaner or automated washer/disinfectors.
- DO NOT use an abrasive cloth or volatile solvents to clean any portion of a cable or wand.
- DO NOT immerse the cables.
- DO NOT immerse the Model 6395 Telemetry Wand or the Model 3203 S-ICD Telemetry Wand.
- DO NOT allow fluid to enter the cavity of the Model 6395 Telemetry Wand or the Model 3203 S-ICD Telemetry Wand.

NOTE: Discard the PSA and ECG cables and wands any time surface cracks appear in the cables and/or the cables discolor, become visibly worn, or if labeling becomes unreadable. See "Environmental Protection and Disposal" on page 61 for disposal information.

Disinfecting the ECG Cable

When necessary, disinfect the ECG cable using a 2% glutaraldehyde solution (such as Cidex), a bleach solution (such as 10% Sodium Hypochlorite), or a general disinfection solution approved for disinfection of medical external devices in the appropriate concentration per the product instructions for use.

Sterilization

NOTE: The Model 3203 S-ICD Telemetry Wand cannot be sterilized.

Ethylene Oxide (EO) Sterilization Instructions

- Prior to sterilization, thoroughly clean the Model 6763 PSA cable or Model 6395 Telemetry Wand as indicated in the "Cleaning Cables and Wands" on page 45.
- Individually wrap each cable in no more than two layers of 1-ply polypropylene wrap (Kimberly-Clark Kimguard™ KC600 wrap, or equivalent) ensuring no exposed surfaces of the device.
- Follow the recommendations of the EO sterilization equipment manufacturer and allow the specified aeration time to fully elapse prior to use.

The Model 6395 Telemetry Wand and the Model 6763 PSA cable may be sterilized using EO.

Table 3. Ethylene Oxide Sterilization Values

Parameter	Value
Temperature	50 °C (122 °F) minimum and 60 °C (140 °F) maximum
Humidity	40% minimum and 80% maximum; non-condensing
EO dwell time	2 hours
EO concentration minimum	450 mg/L
Minimum aeration time	12 hours at 60 °C (140 °F)
Number of sterilization cycles permitted	6395 Telemetry Wand = 25 6763 PSA cable = 50

Steam Sterilization Instructions

- Prior to sterilization, thoroughly clean the Model 6763 PSA cable as indicated in the "Cleaning Cables and Wands" on page 45.
- Individually wrap each cable in no more than two layers of 1-ply polypropylene wrap (Kimberly-Clark Kimguard™ KC600 wrap, or equivalent) ensuring no exposed surfaces of the device.
- Follow the recommendations of the steam sterilization equipment manufacturer and allow the specified drying time to fully elapse prior to use.

Only the Model 6763 PSA cable may be steam sterilized.

Table 4. Steam Sterilization Values

Parameter	Value (gravity sterilizers)		Value (dynamic-air-removal sterilizers)			
Temperature	132 °C (269.6 °F)	135 °C (275.0 °F)	132 °C (269.6 °F)	134 °C (273.2 °F)	135 °C (275.0 °F)	138 °C (280.4 °F)
Steam dwell time	15 minutes	10 minutes	4 minutes	18 minutes	3 minutes	4 minutes
Drying time ¹⁵	30 minutes	30 minutes	30 minutes	30 minutes	16 minutes	16 minutes

Battery Status, Installation, Replacement, and Recycling

The Programmer battery has been tested and approved for hospital and clinic use. Battery status is a percent of charge remaining (see Figure 28 Battery Status Icons Indicating

15. This represents the typical drying time. Once sterilized, ensure that the device is dry prior to removing it from the chamber.

Charge Percentage on page 48) and, for transvenous PGs, is displayed in the upper left corner on the main Programmer screen as illustrated in Figure 27 Battery Status Indicator on Main Screen with AC Power On on page 48 and Figure 28 Battery Status Icons Indicating Charge Percentage on page 48.

NOTE: The battery should be replaced when it no longer maintains a charge above 25%.

NOTE: Depending on the age of the battery, a full charge should last for approximately two hours of normal operation.

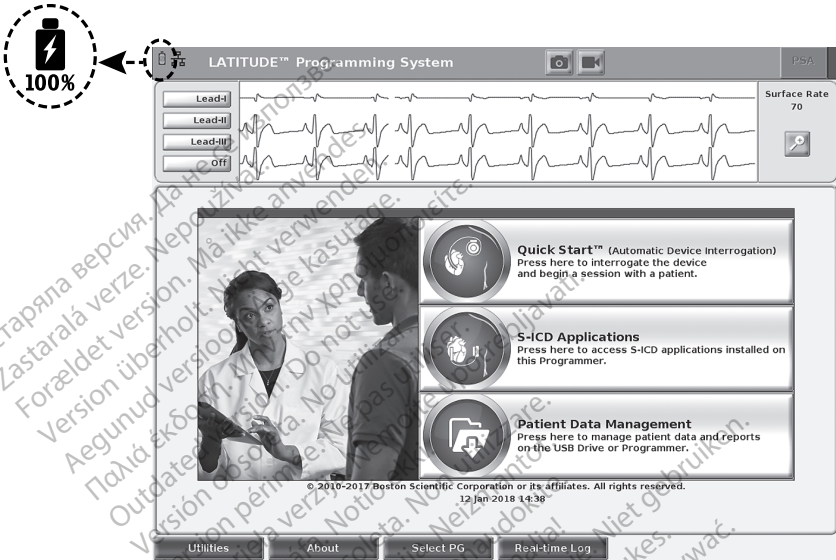

Figure 27. Battery Status Indicator on Main Screen with AC Power On



Battery color: <10% is red, 10-24% is yellow, 25-100% is green

Figure 28. Battery Status Icons Indicating Charge Percentage

An attention message displays on the Programmer screen when the battery reaches 25% depletion. When the battery reaches 10% depletion or less, a warning message displays. At 5%, there is another warning message followed by a 60 second automatic shutdown.

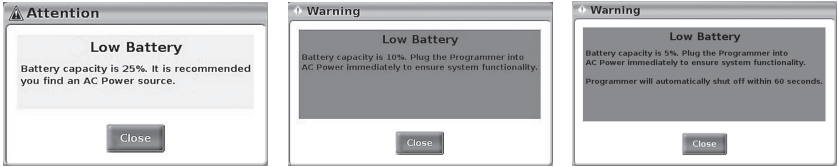

Figure 29. Battery Status - Attention and Warning Pop-ups

In addition, LED indicators on the top right of the battery itself indicate the remaining charge in 25% increments from 100%, 75%, 50%, and 25%. See Figure 31 Replaceable Programmer Battery (representative image) on page 50.

When the S-ICD Application is active, the Programmer battery status displays in the upper right corner of the screen. The battery status is indicated by illuminating from 1 to 4 bars.

- 4 bars illuminated green – 100% charged
- 3 bars illuminated green – 75% charged
- 2 bars illuminated yellow – 50% charged
- 1 bar illuminated red – 25% charged
- battery illuminated solid green with a charging bolt icon – battery is being charged

Battery Replacement



[1] Battery release button [2] Direction to slide cover for removal (reverse the direction to replace the cover)

Figure 30. Battery Compartment on Underside of the Programmer

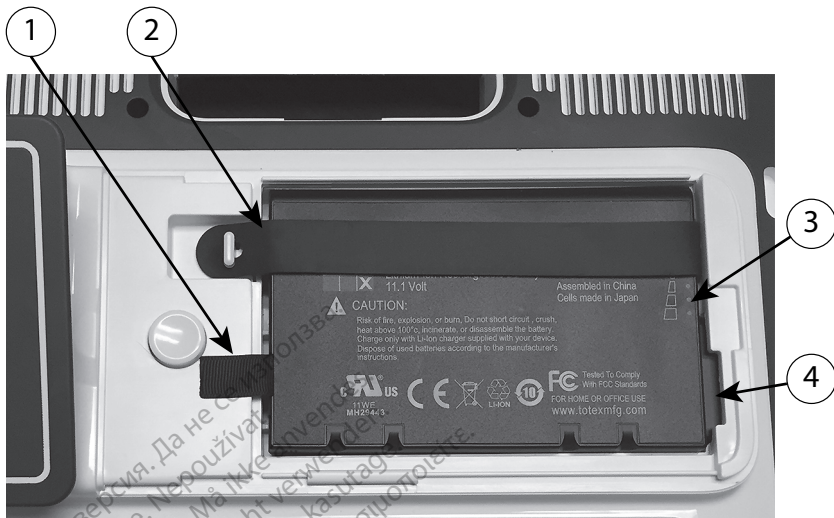

[1] Battery lift out tab [2] Battery retaining strap [3] Battery status indicator LEDs [4] Battery connector terminals (partially hidden)

Figure 31. Replaceable Programmer Battery (representative image)

NOTE: To obtain a replacement battery, contact Boston Scientific using the information on the back cover of this manual.

To remove the battery:

1. Press and release the power button  to turn OFF the Programmer.
2. If connected to AC power, unplug the AC power cord.
3. If connected to the optional stand, unclip the stand and remove it.
4. Place the device screen side down on a soft cloth.
5. Press and hold the battery release button, then slide back the battery cover as illustrated in Figure 30 Battery Compartment on Underside of the Programmer on page 49.
6. Release the battery retaining strap as identified in Figure 31 Replaceable Programmer Battery (representative image) on page 50.
7. Lift out the battery using the black tab attached to the left side of the battery.

WARNING: When accessing the battery, ensure that power to the Programmer is turned off. Do not touch the connector terminals in the battery compartment while removing or replacing the battery because an electrical charge is present.

To install the battery:

1. Insert the new battery (Model 6753) at a slight angle with the battery status indicators on the top right, to make a secure connection between the battery and Programmer contacts.

2. Press down on the left edge of the battery to ensure that the battery is fully seated, to allow the battery cover to fit flush with the case.
3. Determine the charge status by pressing the battery status button on the battery, which is located just above the battery status indicator LEDs.
4. Replace the battery retaining strap.
5. Replace the battery cover by aligning the left edge of the cover with the middle of the battery release button (see Figure 30 Battery Compartment on Underside of the Programmer on page 49).
6. Close the battery cover by sliding the door to the left until you hear an audible click.
7. If the battery charge status is less than 100%, connect the Programmer to AC power. A full recharge from a depleted battery will take about 2 to 2 1/2 hours.

If the Programmer's battery has been substantially depleted, the Programmer may need to be powered Off to allow the battery charging to begin. After several minutes, the Programmer may be powered back On while charging continues.

NOTE: *As long as the Programmer is plugged in (connected to AC power) and the Programmer is powered Off, the battery will charge. The Programmer does not have to be powered On to recharge the battery. However, the Programmer must be turned on in order to check the battery charge status (see Figure 9 Model 3300 Programmer Main Screen on page 26).*

NOTE: *For best results, be sure to charge the battery to 100% before using the Programmer on battery power only.*

Battery Recycling

Boston Scientific recommends that the Lithium-ion battery should be discharged to 25% or less of capacity, as indicated by a red or yellow battery status icon (Figure 28 Battery Status Icons Indicating Charge Percentage on page 48), then recycled in a separate collection for electrical and electronic equipment. Do not place the battery in the trash.

NOTE: *Do not include the battery when returning the Model 3300 Programmer to Boston Scientific Corporation.*

WARNING: The Model 6753 Battery is a Lithium-ion battery and, as such, is deemed a Dangerous Good in regards to shipping. Do not return the Model 6753 battery to Boston Scientific. Dispose of the battery as required by local regulations. If the battery must be shipped, contact your local shipper for instructions and shipping requirements.

Operation and Storage

The LATITUDE Programming System requires special handling. The internal drive of the Model 3300 Programmer must be protected from abusive handling. To protect the device from damage, refer to the following information:

- DO NOT turn off the LATITUDE Programming System while the internal drive is accessing data.
- DO NOT subject the LATITUDE Programming System to shocks or vibrations.
- DO NOT place a magnet on the Programmer.
- DO NOT pour or splash liquid into or onto the Programmer.

- DO NOT strike, scratch, nick, or otherwise mar the touchscreen surface. Be sure to use only fingers or a capacitive stylus on the touchscreen.
- DO NOT disassemble the LATITUDE Programming System.
- When transporting the LATITUDE Programming System from an outside environment to an inside environment, allow the LATITUDE Programming System to acclimate to ambient temperature before use.
- Turn off the LATITUDE Programming System when not in use and prior to transporting it.
- Unplug all external cables and cords prior to transporting the LATITUDE Programming System.
- Keep the vents on the bottom of the Programmer free from obstruction.

Operating and transport conditions are listed in "LATITUDE Programming System Nominal Specifications" on page 70.

If the LATITUDE Programming System has been stored outside of its normal operating conditions, let it sit at ambient temperature until it comes up to operating temperature range before use.

While the Programmer is in operation, the fan will automatically turn on and off as needed to maintain optimum internal temperature. The LATITUDE Programming System is capable of continuous operation and will not shut off automatically if unused for an extended period of time.

CAUTION: The LATITUDE Programming System is not waterproof or explosion-proof and cannot be sterilized. Do not use the Programmer in the presence of flammable gas mixtures including anesthetics, oxygen, or nitrous oxide.

CAUTION: The Model 6753 Lithium-ion battery contains highly flammable chemicals and should be handled with caution. Abuse of this battery can result in fire or explosion. Read the following prior to using this battery:

- Do not expose the battery to temperatures above 140 °F (60 °C).
- Do not puncture the battery as it can lead to a fire or explosion. If the battery housing is punctured, or otherwise visibly damaged, do not attempt to use it.
- Do not strike the battery or otherwise subject it to strong impacts.
- Do not submerge the battery in any fluids.
- Do not connect the + and – terminals with wire or any conductive objects.
- Do not disassemble, modify, or repair the battery.
- Only use the Model 3300 Programmer to charge the battery. Use of any other battery charger can permanently damage the battery or even cause a fire or explosion.

Storing the LATITUDE Programming System

1. Exit the current software application by pressing the End Session button.
2. Press and release the power button  to turn off the LATITUDE Programming System.

NOTE: Before moving the LATITUDE Programming System, always exit the software application and press and release the power button  to turn off the LATITUDE Programming System, then unplug the power cord.

NOTE: If using battery power, press and release the power button  to turn off the device.

3. Unplug the power cord from the wall.
4. Unplug all equipment cables from the side panels of the LATITUDE Programming System.

NOTE: See each accessory's product literature for transport and storage conditions. Ensure each accessory is maintained within the appropriate limits.

Long Term Storage of the LATITUDE Programming System

If the Programmer is to be stored for long periods (e.g. months), remove the battery to prevent it from discharging to a point where recharging would be required in order to use it again. See "Battery Status, Installation, Replacement, and Recycling" on page 47 for instructions on removing the battery.

Maintenance Check and Safety Measures

LATITUDE Programming System Maintenance Check

Prior to each use, you should perform a visual inspection and verify the following:

- Mechanical and functional integrity of the LATITUDE Programming System, cables, and accessories.
- Legibility and adherence of the LATITUDE Programming System labels.
- Perform "Startup" on page 25. The normal power-up process verifies that the LATITUDE Programming System has passed its internal checks and is ready for use.

NOTE: The LATITUDE Programming System does not contain any user-serviceable parts and it does not have a calibration requirement. Maintenance does not require any additional steps.

The LATITUDE Programming System contains only one user-accessible component, the Model 6753 replaceable Lithium-ion battery.

NOTE: The Programmer must be returned without the battery for replacement or repair of any internal components. See "Battery Recycling" on page 51 for additional details.

Safety Measurements

National regulations may require that the user, manufacturer, or manufacturer representative periodically perform and document safety tests of the device. If such testing is required in your country, follow the testing interval and extent of testing as regulated in your country. If you do not know the national regulations in your country, please contact your local Boston Scientific representative.

It is not necessary that technical and safety inspections be performed by Boston Scientific personnel. However, technical and safety inspections of the Programmer and its accessories must be performed by persons, who, based on their training, knowledge, and

practical experience, are capable of adequately performing such inspections and who do not require instructions with regard to the technical and safety inspection.

If IEC/EN 62353 is a required standard in your country, but no specific testing or interval is specified, it is recommended that you perform safety testing using the direct method as specified in IEC/EN 62353 at an interval of every 24 months or as per local regulations. Refer to "Compromised Programmer" on page 69.

Service

For questions regarding operation or repair of the LATITUDE Programming System, contact Boston Scientific using the information on the back cover of this manual. The LATITUDE Programming System must be serviced by Boston Scientific personnel only.

If the LATITUDE Programming System malfunctions and requires repair, help to ensure efficient service by following these guidelines:

1. Leave the configuration of the instrument exactly as it was at the time of malfunction. Contact Boston Scientific using the information on the back cover of this manual.
2. Write a detailed description of the malfunction(s).
3. Save printouts or other materials that illustrate the problem, if possible.
4. Be sure to save all PG data to a USB pen drive before returning a LATITUDE Programming System to Boston Scientific, as all patient and PG data will be erased from the LATITUDE Programming System when it is returned for service.
5. If the LATITUDE Programming System must be returned to Boston Scientific for service, remove the Lithium-ion battery from the Programmer, pack the device in the shipping container in which it was received or in a shipping container provided by Boston Scientific. Do not include the Lithium-ion battery when returning the Programmer to Boston Scientific Corporation.
6. For the shipping address, contact Boston Scientific using the information on the back cover of this manual.

TROUBLESHOOTING

If the LATITUDE Programming System does not operate properly, check that electrical cords and cables are securely connected and that cords and cables are in good working order (i. e., free of visible defects). Possible causes and corrective actions for problems listed below.

Table 5. Possible Causes and Corrective Actions for LATITUDE Programming System Problems

Symptom	Possible Cause	Corrective Action
Telemetry: poor, intermittent, or no communication	Incorrect application software or incorrect LATITUDE Programming System for PG	Install proper application software for PG in use. Use correct LATITUDE Programming System for the PG being interrogated.
		Contact Boston Scientific using the information on the back cover of this manual to confirm PG and Model 3300 Programmer compatibility.

Table 5. Possible Causes and Corrective Actions for LATITUDE Programming System Problems
(continued)

Symptom	Possible Cause	Corrective Action
	Incorrect telemetry wand	Use only the Model 6395 Telemetry Wand for transvenous PGs. Use only the Model 3203 S-ICD Telemetry Wand for S-ICD PGs. If the 3203 S-ICD PG Telemetry Wand is not being used for S-ICD programming or as an additional antenna for transvenous PG programming, ensure that it is disconnected from the Programmer.
	Poor connection between a telemetry wand and the Programmer	Disconnect and reconnect the Telemetry Wand to the Programmer. Use only the Model 6395 Telemetry Wand for transvenous PGs.
	Programmer running on battery power only	Connect the Programmer to AC power to improve telemetry performance.
	Excessive radio emissions from equipment	Reposition the LATITUDE Programming System. Also see Noise problems: ECG.
	Incomplete telemetry communication with Model 6395 Telemetry Wand	Reposition the Model 6395 Telemetry Wand over the PG; repeat interrogation. Flip the wand over. Disconnect and reconnect the wand. Turn off the Programmer, and then turn it On. Repeat interrogation.
		Use another Model 3300 Programmer or Model 6395 Telemetry Wand. Repeat interrogation.
		If this does not correct the issue, contact Boston Scientific using the information on the back cover of this manual.

Table 5. Possible Causes and Corrective Actions for LATITUDE Programming System Problems
(continued)

Symptom	Possible Cause	Corrective Action	
	Incomplete telemetry communication with Model 3203 S-ICD Telemetry Wand	For S-ICD interrogation and programming, make sure the Model 3203 S-ICD Telemetry Wand is positioned on the S-ICD PG.	
		Use another Model 3300 Programmer or Model 3203 Telemetry Wand. Repeat interrogation.	
		If this does not correct the issue, contact Boston Scientific using the information on the back cover of this manual.	
		Telemetry RF signal obstructed	Assure that a clear line-of-sight path exists between the LATITUDE Programming System and PG. Repeat interrogation.
		Telemetry RF signal interference	Reposition LATITUDE Programming System. Unplug USB devices. Repeat interrogation.
		RF Telemetry fails	Reposition the Model 6395 Telemetry Wand over the transvenous PG and repeat interrogation.
		LATITUDE Programming System software version not current	For transvenous PG ^b programming, the Model 3203 S-ICD Telemetry wand may be used as an additional antenna. Contact Boston Scientific using the information on the back cover of this manual.
Noise problems: ECG	Improper patient connections	Recheck patient leads for adequate skin contact and correct limb lead placement. Confirm Right Leg Drive is connected. Refer to ECG textbooks for additional ECG techniques.	
	Excessive radio emissions from equipment	Check surrounding area for electrical equipment that is powered on and not needed. Move unneeded equipment	

Table 5. Possible Causes and Corrective Actions for LATITUDE Programming System Problems
(continued)

Symptom	Possible Cause	Corrective Action
		away from patient and/or LATITUDE Programming System, or turn off unneeded equipment.
		Route ECG cable away from potential noise sources such as other equipment and associated cabling to include AC cords.
		Ground Programmer to the conductive patient bed (when applicable) using a USB grounding cable. Intertwine excess ECG lead lengths when possible. Refer to ECG textbooks for additional ECG techniques.
		Check for building outlet ground resistance less than 10 Ω , when measured with low impedance techniques, between the outlets and from the outlets to other grounded points in the room (e.g., room bonding point, cold-water pipe, exam table, etc.).
Telemetry: interference	Harmful interference caused by the LATITUDE Programming System or the system is negatively impacted by other RF devices	Reorient or relocate the devices.
		Increase the separation distance between the devices.
		Connect the equipment to an outlet on a different circuit or use as battery powered.
		Contact Boston Scientific using the information on the back cover of this manual.
Missing shock markers during the delivery of a shock	Noise during shock delivery may prevent the shock marker from being received at the maximum telemetry distance of 6 cm (2.35 in)	Review surface ECG for confirmation of delivered shock, if available. For transvenous PGs, review the Arrhythmia Logbook for confirmation of delivered shock.

Table 5. Possible Causes and Corrective Actions for LATITUDE Programming System Problems
(continued)

Symptom	Possible Cause	Corrective Action
Displayed clock does not consistently keep time after setting	Low internal clock battery	The internal clock battery is not field replaceable. Return the LATITUDE Programming System to Boston Scientific for replacement of the internal clock battery.
Unable to print to a USB-attached printer	Not connected properly	Check the USB cable connections between the printer and the Programmer.
	No power	Check the printer's power connection.
	Printer not recognized	Re-connect the printer to the USB port, then wait 30 seconds for the system to recognize the printer before sending files to the printer.
Touchscreen does not respond or goes blank	Selecting inactive buttons on the touchscreen	Select active buttons.
	Touchscreen not functioning	Turn off the LATITUDE Programming System, and then turn it On. Do not touch the screen while the Programmer is powering up, as this may cause the area that was touched to become unresponsive when pressed later on.
		If this does not correct the issue, contact Boston Scientific using the information on the back cover of this manual.

Table 5. Possible Causes and Corrective Actions for LATITUDE Programming System Problems
(continued)

Symptom	Possible Cause	Corrective Action
LATITUDE Programming System not responding	LATITUDE Programming System not functioning	Turn off the LATITUDE Programming System, and then turn it on. Do not touch the screen while the Programmer is powering up, as this may cause the area that was touched to become unresponsive when pressed later on.
		If this does not correct the issue, contact Boston Scientific using the information on the back cover of this manual.
External monitor not displaying properly	Cable/adaptor connection to DisplayPort	Remove and re-insert cable/adaptor into DisplayPort to re-synchronize the video signal.

- a. The Model 3203 S-ICD Telemetry Wand may be used as an additional antenna for transvenous PGs to improve reception.
b. ALTRUA/INSIGNIA I/NEXUS I PGs use only wanded telemetry.

HANDLING

The emissions characteristics of this equipment make it suitable for use in industrial areas and hospitals (CISPR 11 class A).

Using an External ECG Monitor with the Model 3300 Programmer

Use the following accessories to set up the configuration described in this section:

- Model 6629 ECG-BNC Cable
- Model 6395 Telemetry Wand for transvenous PGs

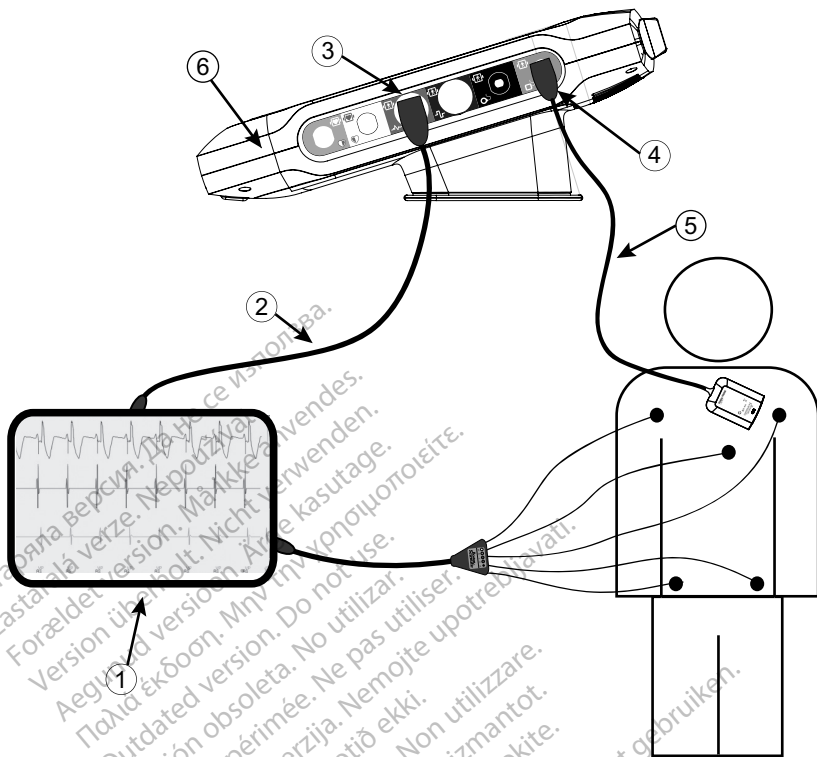

[1] ECG monitor, [2] ECG-BNC cable, [3] Programmer ECG connector, [4] Programmer Model 6395 Telemetry Wand connector, [5] Model 6395 Telemetry Wand, [6] LATITUDE Programming System (right side view)

Figure 32. External ECG Monitor Configuration

To display a tracing on an external ECG monitor and the Programmer, set up equipment as shown in Figure 32 External ECG Monitor Configuration on page 60.

In the example in Figure 32 External ECG Monitor Configuration on page 60, the surface ECG signal travels the following route for a patient with a transvenous pulse generator:

1. External ECG monitor
2. Model 6629 ECG-BNC cable
3. Programmer ECG connector
4. Programmer Model 6395 Telemetry Wand connector (used for transvenous PG programming)
5. Model 6395 Telemetry Wand for transvenous PG programming
6. Model 3300 Programmer

Environmental Protection and Disposal

The Programmer and accessories are designed to provide years of service under typical use. When no longer needed:

- Return or exchange a Programmer by contacting Boston Scientific using the information on the back cover of this manual. **Do not dispose of the Programmer in the trash or at electronics recycling facilities as it may contain sensitive personal information.**

When returning a LATITUDE Programming System to Boston Scientific, be sure to save all PG data to a USB pen drive because all patient and PG data will be erased from the LATITUDE Programming System when it is received by Boston Scientific.

- Dispose of accessories, such as the wand and power cord, in a separate collection for electrical and electronic equipment. Do not place accessories in the trash.
- Dispose of digital data storage media, such as USB pen drives, in accordance with applicable privacy and security policies and regulations.

NOTE: The Programmer must be returned without the battery. See "Battery Recycling" on page 51 for additional details.

WARNING: The Model 6753 Battery is a Lithium-ion battery and, as such, is deemed a Dangerous Good in regards to shipping. Do not return the Model 6753 battery to Boston Scientific. Dispose of the battery as required by local regulations. If the battery must be shipped, contact your local shipper for instructions and shipping requirements.

Symbols on Devices and Packaging

The following symbols may be present on LATITUDE Programming System devices, packaging, and labeling.

Table 6. Symbols on Devices and Packaging









Symbol	Description
	Reference number
	Serial number
	Lot number
	Assembly number
	Manufacturer
	Authorized Representative in the European Community
	Australian Sponsor Address
	Date of manufacture

Table 6. Symbols on Devices and Packaging (continued)













Symbol	Description
	Non-ionizing electromagnetic radiation; ZIP telemetry indicator light
	Sterilized using ethylene oxide
	Consult instructions for use
	Follow instructions for use
	Follow instructions for use; see www.bostonscientific-labeling.com
	Australia – RCM symbol Compliance with the Australian Communications and Media Authority's (ACMA) regulatory arrangements for telecommunications, radio, EMC and electromagnetic energy (EME)
R-NZ	New Zealand – RF Compliance Mark
	Japan – Giteki mark
	Alternating current
	The power button on the left side of the Programmer, which is represented by the Standby symbol
	USB 2.0
3.0 	USB 3.0
DP++	DisplayPort
	Local Area Network (LAN) Port
	Model 3203 S-ICD Telemetry Wand

Table 6. Symbols on Devices and Packaging (continued)

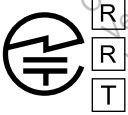



























Symbol	Description
	Model 6395 Telemetry Wand
	PSA LV
	PSA RA, RV
	Defibrillation-proof type CF applied part
	Defibrillation-proof type BF applied part
	ECG cable connector
	Future connection
	Mark for nationally recognized testing for safety standards
	Red STAT button on Programmer provides commands for low voltage and high voltage rescue
	Warning, electricity – Do not touch the connector terminals in the Programmer battery compartment while removing or replacing the battery as an electrical charge is present
	ISO 7010-W001 general warning symbol for ECG connector on the Programmer
	Indicates the risk of electric shock; (do not touch contacts inside battery compartment); refer servicing to Boston Scientific
	Waste, Electrical, and Electronic Equipment (WEEE); indicates separate collection for electrical and electronic equipment (i.e., do not throw this device in the trash)
	This side up
	Fragile, handle with care

Table 6. Symbols on Devices and Packaging (continued)

Symbol	Description
	Keep dry
	Do not use hooks
	Temperature limitation
	Humidity limitation
	Atmospheric pressure limitation
	Recycle box
	MR Unsafe
	Battery indicator symbol
	Bluetooth
	DC power connection
	Medical Device under EU Legislation
	Contents
	Non-sterile

SAFETY, COMPLIANCE, AND COMPATIBILITY STANDARDS

The following standards apply to the LATITUDE Programming System.

Safety Standards

The LATITUDE Programming System has been tested and found to comply with applicable safety portions of the following standards:

- IEC 60601-1:2005/A1:2012
- IEC 80001-1:2010
- ANSI/AAMI ES60601-1:2005(R)2012
- EN 60601-1:2006 + A1:2013
- CAN/CSA-C22 No. 60601-1:2014
- EN 62479:2010
- EN 62311:2008

Electromagnetic Compatibility Standards

The LATITUDE Programming System has been tested and found to comply with the applicable portions of the FCC and IEC electromagnetic compatibility (EMC) standards:

- FCC Part 15.209:2016 + 15.207:2016 + 15.249:2016
- IEC 60601-1-2:2014
- ETSI EN 301 489-1 V2.1.1:2017
- ETSI EN 301 489-3 V2.1.1:2017
- ETSI EN 301 489-17 V3.1.1:2017
- ETSI EN 301 489-27 V2.1.1:2017
- ETSI EN 301 489-31 V2.1.1:2016

The LATITUDE Programming System is also compliant with the Australian Communications and Media Authority's (ACMA) regulatory arrangements for telecommunications, radio, EMC, and electromagnetic energy (EME).

Radio Spectrum Compliance Standards

The LATITUDE Programming System complies with the applicable portions of the following radio spectrum compliance standards:

- ETSI EN 302 195 V2.1.1:2016
- ETSI EN 300 220-1 V3.1.1:2016
- ETSI EN 300 220-2 V3.1.1:2016
- ETSI EN 300 328 V2.1.1:2016
- ETSI EN 301 839 V2.1.1:2016
- ETSI EN 301 893 V2.1.1:2017

NOTE: Use special precautions regarding EMC during the installation and the use of the LATITUDE Programming System, according to the EMC instructions given throughout this manual. Refer to the details about the LATITUDE Programming System electromagnetic emissions and immunity in Table 8 LATITUDE Programming System Nominal Specifications on page 70 and Table 9 Radio Nominal Specifications on page 72.

NOTE: Use caution when using RF portable and mobile telephony equipment in close proximity to the LATITUDE Programming System. Refer to the details about the LATITUDE Programming System electromagnetic immunity in Table 10 Network and Connectivity Specifications on page 73.

Electromagnetic Emissions and Immunity

IEC 60601-1-2:2014 Information

This equipment has been tested and found to comply with the applicable limits for Class A medical devices in a professional healthcare facility environment to ANSI/AAMI/IEC 60601-1-2:2014 [or BS EN 60601-1-2:2015 or Active Implantable Medical Device Directive 90/385/EEC]. This testing shows the device provides reasonable protection against harmful interference in a typical medical installation. However, there is no guarantee that interference will not occur in a particular installation.

Industry Canada (IC)

This device complies with the applicable Radio Standards Specifications (RSS). Operation is subject to the following two conditions:

1. This device may not cause harmful interference, and
2. This device must accept any interference received, including interference that may cause undesired operation of the device.

WARNING: No modification of this equipment is allowed unless approved by Boston Scientific. Changes or modifications not expressly approved by Boston Scientific could void the user's authority to operate the equipment.

This device may not interfere with stations operating in the 400.150–406.000 MHz band in the meteorological aids, meteorological-satellite, and earth exploration-satellite services, and must accept any interference received, including interference that may cause undesired operation.

The electromagnetic emissions and immunity information is provided in Table 7 Guidance and Manufacturer's Declaration—Electromagnetic Compatibility on page 67.

Table 7. Guidance and Manufacturer's Declaration—Electromagnetic Compatibility

The LATITUDE Programming System, Model 3300, is suitable for use in professional health care facility environments. The customer or the user of this system should assure that it is used in such an environment.		
Test	Compliance	Electromagnetic environment—guidance
Protection of radio services and other equipment	CISPR 11 Group 1 Class A	The LATITUDE Programming System, Model 3300, uses RF energy only for its intended uses in communication with the implanted device or connectivity functions. Its RF emissions are very low and are not likely to cause any interference in nearby electronic equipment.
Protection of the public mains network	CISPR 11 Class A IEC 61000-3-2 IEC 61000-3-3	The LATITUDE Programming System, Model 3300, is suitable for use in professional health care facility environments.
Electrostatic Discharge	± 8 kV contact ± 2 kV, ± 4 kV, ± 8 kV, and ± 15 kV air	
Radiated RF EM field	3 V/m from 80 MHz to 2.7 GHz	
Proximity fields from RF wireless communications equipment	380 - 390 MHz: 27 V/m 430 - 470 MHz: 28 V/m 704 - 787 MHz: 9 V/m 800 - 960 MHz: 28 V/m 1700 - 1900 MHz: 28 V/m 2400 - 2570 MHz: 28 V/m 5100 - 5800 MHz: 9 V/m	
Rated power frequency magnetic field	30 A/m	
Electrical fast transients/bursts	± 2 kV input AC power ± 1 kV SIP/SOP	
Surges line-to-line	± 0.5 kV, ± 1 kV input AC power	
Surges line-to-ground	± 0.5 kV, ± 1 kV, ± 2 kV input AC power	
Conducted disturbances induced by RF fields	3 V/m from 0.15 MHz to 80 MHz 6 V/m in ISM bands from 0.15 MHz to 80 MHz	The ISM bands between 0.15 MHz and 80 MHz are 6.765 MHz to 6.795 MHz 13.553 MHz to 13.567 MHz 26.957 MHz to 27.283 MHz 40.66 MHz to 40.70 MHz.

Table 7. Guidance and Manufacturer’s Declaration—Electromagnetic Compatibility (continued)

The LATITUDE Programming System, Model 3300, is suitable for use in professional health care facility environments. The customer or the user of this system should assure that it is used in such an environment.		
Test	Compliance	Electromagnetic environment—guidance
		The amateur radio bands between 0.15 MHz and 80 MHz are 1.8 MHz to 2.0 MHz 3.5 MHz to 4.0 MHz 5.3 MHz to 5.4 MHz 7.0 MHz to 7.3 MHz 10.1 MHz to 10.15 MHz 14.0 MHz to 14.2 MHz 18.07 MHz to 18.17 MHz 21.0 MHz to 21.4 MHz 24.89 MHz to 24.99 MHz 28.0 MHz to 29.7 MHz 50.0 MHz to 54.0 MHz.
Voltage dips ^a	0% U_T for 0.5 cycle at 0°, 45°, 90°, 135°, 180°, 225°, 270°, and 315° 0% U_T for 1 cycle and 70% U_T for 25/30 cycles at 0°	
Voltage interruptions ^a	0% U_T for 250/300 cycles	

a. Voltage dips and interruptions: U_T is the AC mains voltage prior to application of the test level.

LATITUDE PROGRAMMING SYSTEM SECURITY

Sensible security practices are needed to protect patient data and the LATITUDE Programming System integrity when connected to a network. The Programmer incorporates features that facilitate management of network security. These features work in conjunction with the security practices of hospitals and clinics to provide safe and secure operation of the Programmer and protect the attached network.

NOTE: All patient data is encrypted on the Programmer internal drive, and the Programmer has network security safeguards in place to prevent malicious attacks.

Software

All installed software has been approved by Boston Scientific and general purpose software installation is not permitted. This minimizes the potential for vulnerabilities to be exposed. Internal software that runs the Programmer is locked from change and is re-verified upon each execution. Whenever Boston Scientific software updates are available, install them as soon as possible. Programmer settings should only be modified per guidance from verified Boston Scientific technical support or Health Care Delivery personnel.

Patient Data Management

Refer to the *Patient Data Management Operator's Manual (Model 3931)* for additional security information.

Network

Refer to the *Network and Connectivity Operator's Manual (Model 3924)* for additional networking and connectivity security information.

Unsupported Hardware

Unsupported hardware, including unsupported USB devices, is ignored by the Programmer and is not accessed.

Security Vigilance

Boston Scientific continues to work with its partners to analyze emerging threats and evaluate potential impact on the LATITUDE Programming System.

Physical Controls

Maintain good physical controls over the Programmer. Having a secure physical environment prevents access to the internals of the Programmer. USB devices connected to the Programmer should be controlled to limit potential introduction of malware. Patient sensitive information may be stored on the Programmer and appropriate precautions should be taken to secure the Programmer from unauthorized access.

Compromised Programmer

If you believe that the Programmer has been compromised by a security threat, turn off the Programmer, disconnect it from the network, then restart the LATITUDE Programming System. Discontinue use of the Programmer if it fails the start-up self test or does not operate as expected. For further assistance, contact Boston Scientific using the information on the back cover of this manual.

SPECIFICATIONS

Table 8. LATITUDE Programming System Nominal Specifications

Characteristic	Nominal
Safety classification	<p>LATITUDE Programming System: Class I.</p> <ul style="list-style-type: none"> • ECG connection: Type BF, defibrillation-protected • Model 6395 Telemetry Wand connection: Type BF, defibrillation-protected • Model 3203 S-ICD Telemetry Wand connection: Type BF, defibrillation-protected • Connection port for future use: Type BF, defibrillation-protected • PSA cable connections: Type CF, defibrillation-protected • Ingress protection rating: IPX0
Dimensions	<p>Programmer without Stand: 30.7 cm (12.1 in) deep, 34 cm (13.4 in) wide, 12.5 cm (4.9 in) high With Stand (in handle up position): 24.9 cm (9.8 in) deep, 35.1 cm (13.8 in) wide, 31.8 cm (12.5 in) high</p>
Weight (approximate)	<p>Programmer (without battery or stand): 3.58 kg (7.9 lbs) Battery: 0.45 kg (1.0 lb) Stand: 1.28 kg (2.75 lb)</p>
Model 6689 power adapter power rating	100-240 V, 50-60 Hz, 1.5 A
Maximum Output DC cord length Dimensions	<p>15 V @ 6 A, 90 W 1.53 m (5 ft) 14.94 cm x 6.26 cm x 3.35 cm (5.88 in x 2.46 in x 1.32 in)</p>
AC power cord (3 prong)	2.05 m (6.72 ft) 100-240 V
Duty cycle	Continuous
Operating temperature	10 °C to 32 °C (50 °F to 90 °F)
Transport and storage temperature	-20 °C to 60 °C (-4 °F to 140 °F)
Operating humidity	25% to 85% non-condensing
Transport and storage humidity	25% to 85% non-condensing

Table 8. LATITUDE Programming System Nominal Specifications (continued)

Characteristic	Nominal
Operating altitude	≤ 3,000 m (≤ 9,843 ft)
Transport and storage atmospheric pressure	50 kPa to 106 kPa (7.252 psi to 15.374 psi)
External support; pen drives, printer	(3) USB 2.0 ports; (1) USB 3.0 port
External digital monitor support	DisplayPort digital connector; Monitor must comply with emissions standard CISPR 32.
Battery type	Lithium-ion, IEC62133:2012 and UN38.3 compliant
Ethernet: Data Interface	Data Interface RJ-45 Ethernet Connector
Data Modulation	IEEE 802.3u, 100 Mbps full duplex and half duplex on 100BASE-T IEEE 802.3ab, 1 Gbps full duplex and half duplex on 1000BASE-T
Wi-Fi	IEEE 802.11g, 802.11n, and 802.11ac
ECG cable, Model 3154	3.9 m to 4.3 m (12.7 ft to 14.0 ft)
ECG cable, Model 3153 (for Canada and China only)	3.9 m to 4.3 m (12.7 ft to 14.0 ft)
ECG performance:	
Minimum amplitude detected	6.54 μ V
Lead selection	I, II, III, aVR, aVL, aVF
Intrinsic and paced ventricular rate display	30 min ⁻¹ to 120 min ⁻¹ \pm 4 min ⁻¹ on a three-beat average basis; 120 min ⁻¹ to 240 min ⁻¹ \pm 8 min ⁻¹ on a three-beat average basis
Input impedance	\geq 1.5 M Ω
Electrode offset tolerance	300 mV
Storage resolution	500 samples/sec, 6.54 μ V
Filter settings for storage resolution	ON: 0.5 Hz to 40 Hz, \pm 10% or \pm 0.1 Hz, whichever is greater OFF: 0.05 Hz to 100 Hz, \pm 20% or \pm 0.02 Hz, whichever is greater
Gain settings	0.5, 1, 2, 5, 10, 20 mm/mV \pm 25%
Electrical Safety Testing- Reference for testing according to the IEC 62353 (Installation, Maintenance, Repair) ^{a b}	
Earthbond testing (Groundbond testing)	\leq 300 m Ω including power cable not exceeding 3 meters

Table 8. LATITUDE Programming System Nominal Specifications (continued)

Characteristic	Nominal
Equipment leakage, direct method (accessible parts)	≤ 500 μA
Patient leakage current, direct method	Model 6395 Telemetry Wand (BF) ≤ 5000 μA, ECG (BF) ≤ 5000 μA, PSA (CF) ≤ 50 μA
Safety Feature: Defibrillator protection	Up to 5000 V

- For questions regarding operation or repair of the LATITUDE Programming System, contact Boston Scientific using the information on the back cover of this manual. The LATITUDE Programming System must be serviced by Boston Scientific personnel only.
- After successfully completing safety testing, verify the LATITUDE Programming System continues to meet the essential performance as defined in the beginning of this manual.

Table 9. Radio Nominal Specifications

Characteristic	Nominal
ZIP MICS Telemetry (MICS/MedRadio)	
Frequency band	402 – 405 MHz Medical Implant Communication Service (MICS) Medical Device Radio Communication Service (MedRadio)
Bandwidth	< 145 kHz
Modulation	FSK
Radiated power	< 25 μW E.R.P.
ZIP SRD Telemetry (Short Range Devices)	
<i>NOTE: This SRD Telemetry is NOT used in Australia and New Zealand</i>	
Frequency band	869.7 – 870.0 MHz Short Range Device radio band (SRD)
Bandwidth	< 120 kHz
Modulation	ASK
Radiated power	< 1.2 mW E.R.P.
Receiver category	2
ZIP SRD Telemetry (Short Range Devices)	
<i>NOTE: This SRD Telemetry is used only in Australia and New Zealand</i>	
Frequency	916.5 MHz Short Range Device radio band (SRD)
Bandwidth	< 650 kHz
Modulation	ASK
Radiated power	< 0.75 mW E.I.R.P.
Model 6395 Wand Telemetry (Inductive)	
Frequency band	Transmit: 21 kHz Receive: 0 – 100 kHz
Bandwidth	< 125 kHz

Table 9. Radio Nominal Specifications (continued)

Characteristic	Nominal
Modulation Radiated power Receiver category	OOK/QPSK 11.3 dBμA/m @ 10 m 3
Model 3203 S-ICD Wand Telemetry	
Frequency band Bandwidth Modulation Radiated Power	402 – 405 MHz < 145 kHz FSK < 25 μW E.R.P
Bluetooth*	
Frequency band Bandwidth Modulation Radiated power Receiver category	2400.0 – 2483.5 MHz < 1.4 MHz GFSK, π/4-DQPSK, 8DPSK < 9.6 mW E.I.R.P. 2
Wi-Fi 2.4 GHz	
Wi-Fi connectivity is not permitted in Indonesia.	
Frequency band Bandwidth Modulation Radiated power	2400.0 – 2483.5 MHz 20/40 MHz IEEE 802.11b/g/n < 80 mW E.I.R.P.
Wi-Fi 5.0 GHz	
Wi-Fi connectivity is not permitted in Indonesia.	
Frequency bands Bandwidth Modulation Radiated power	5150 – 5350 MHz 5470 – 5725 MHz 20/40/80 MHz IEEE 802.11a/n/ac < 50 mW E.I.R.P.

Table 10. Network and Connectivity Specifications

Characteristic	Specification
Required Characteristics of IT Network	
Ethernet	IEEE 802.3u, 100 Mbps full duplex and half duplex on 100BASE-TX IEEE 802.3ab, 1 Gbps full duplex and half duplex on 1000BASE-T
Wi-Fi	IEEE 802.11g, 802.11n, and 802.11ac
Hazardous situations resulting from network failure	None

Table 10. Network and Connectivity Specifications (continued)

Characteristic	Specification
Network and Security Configuration	
Ethernet	Dynamic or Static IP addressing
Ethernet Required Connectivity:	
Source Destination URLs	Model 3300 Programmer crm.iot.bsci.com cumulocity-prod-crm-us-east-1.s3.us-east-1.amazonaws.com cumulocity-prod-logs-crm-us-east-1.s3.us-east-1.amazonaws.com
Protocol Name	TLS
Transport Protocol	TCP
Port Range	443, 8443 (outbound)
Source Destination URL	Model 3300 Programmer pool.ntp.org
Protocol Name	NTP
Transport Protocol	UDP
Port Range	123 (outbound)
Wi-Fi	Dynamic IP addressing, using IEEE 802.11g, 802.11n, or 802.11ac specifications to connect to networks that are public/unsecured, WPA-PSK, or WPA2-PSK
Ethernet MAC address	The network MAC address can be displayed and the host name is editable
Internet protocol	IPv4
Dynamic Host Configuration Protocol (DHCP) mode	Both manual and automatic DHCP modes are supported
Wi-Fi MAC address	Displayable

WARRANTY INFORMATION

This product has a limited warranty. See www.bostonscientific.com/warranty for warranty information.

European Union Importer

EU Importer: Boston Scientific International B.V., Vestastraat 6, 6468 EX Kerkrade, The Netherlands.

Остаряла версия. Да не се използва.
Zastaralá verze. Nepoužívat.
Forældet version. Må ikke anvendes.
Version überholt. Nicht verwenden.
Aegunud version. Må ekki notuð.
Παλιά έκδοση. Μην την χρησιμοποιείτε.
Outdated version. Do not use.
Version obsolete. Ne pas utiliser.
Version périmée. Nemojte upotrebljavati.
Zastarjela verzija. Ne koristiti.
Úreilt útgáfa. Notið ekki.
Versione obsoleta. Non utilizzare.
Novecojsi versija. Nenaudokite.
Pasenusi versija. Neizmantot.
Elavult verzió. Ne használjal.
Dit is een verouderde versie. Niet gebruiken.
Utdatert versjon. Skal ikke brukes.
Wersja przeterminowana. Nie używać.
Versão obsoleta. Não utilize.
Versiune expirată. A nu se utiliza.
Zastaraná verzija. Nepoužívat.
Zastarela različica. Ne uporabite.
Vanhentunut versio. Älä käytä.
Föråldrad version. Använd ej.
Güncel olmayan sürüm. Kullanmayın.

Остаряла версия. Да не се използва.
Zastaralá verze. Nepoužívat.
Forældet version. Må ikke anvendes.
Version überholt. Nicht verwenden.
Version up-to-date. Μην την χρησιμοποιείτε.
Πολύ έκδοση. Μην την χρησιμοποιείτε.
Outdated version. Do not use.
Version obsolete. Ärge kasutage.
Version périmée. Ne pas utiliser.
Zastarjela verzija. Nemojte upotrebljavati.
Úrejt utgáfa. No utilitzar.
Versione obsoleta. Ne utiliziser.
Novecojsi verzija. Nenaudokite.
Pasenusi verzija. Non utilizzare.
Elavult verzió. Neizmantot.
Dit is een verouderde versie. Niet gebruiken.
Utdatert versija. Nie używać.
Wersja przeterminowana. Nie używać.
Versão obsoleta. Não utilize.
Versiune expirată. A nu se utiliza.
Zastaraná verzija. Nepoužívat.
Zastarela različica. Ne uporabite.
Vanhentunut versio. Älä käytä.
Föråldrad version. Använd ej.
Güncel olmayan sürüm. Kullanmayın.

Остаряла версия. Да не се използва.
Zastaralá verze. Nepoužívat.
Forældet version. Må ikke anvendes.
Version überholt. Nicht verwenden.
Aegunud version. Må ekki notuð.
Παλιά έκδοση. Μην την χρησιμοποιείτε.
Outdated version. Do not use.
Version obsolete. Ne pas utiliser.
Version périmée. Nemojte upotrebljavati.
Zastarjela verzija. Ne uporabite.
Úrejt útgáfa. Notið ekki.
Versione obsoleta. Non utilizzare.
Novcojusi versija. Nenaudokite.
Pasenusi versija. Neizmantot.
Elavult verzió. Ne használjal.
Dit is een verouderde versie. Niet gebruiken.
Utdatert versjon. Skal ikke brukes.
Wersja przeterminowana. Nie używać.
Versão expirada. Não utilize.
Versiune expirată. A nu se utiliza.
Zastaraná verzija. Nepoužívat.
Zastarela različica. Ne uporabite.
Vanhentunut versio. Älä käytä.
Föråldrad version. Använd ej.
Güncel olmayan sürüm. Kullanmayın.



Boston Scientific Corporation
4100 Hamline Avenue North
St. Paul, MN 55112-5798 USA



Guidant Europe NV/SA; Boston Scientific
Green Square, Lambroekstraat 5D
1831 Diegem, Belgium

www.bostonscientific.com

1.800.CARDIAC (227.3422)

+1.651.582.4000

© 2022 Boston Scientific Corporation or its affiliates.

All rights reserved.

92362142-055 EN Europe 2022-02



CE 2797

