

Endoscopy

**Boston
Scientific**
Advancing science for life™

2015

REFERENCE GUIDE

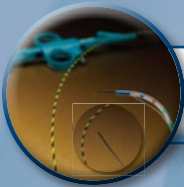

Biliary Access



Biliary Devices

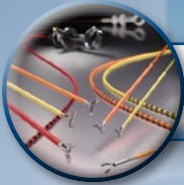

Biopsy



Dilation



Enteral Access



EUS FNA

Hemostasis



Pulmonary



SpyGlass™
Direct Visualization System



Stents:
Enteral & Esophageal



Tissue Resection



While in Stock



Future Product Updates

Product Guide

Services

Interactive Product Guide

| | |
|---|---|
|  Active Cords..... 14, 74 |  Endostat III Bipolar / Monopolar Electrosurgical Generator 52 |
|  Advanix™ Center Bend - Single Stent..... 21 |  EndoVive™ Low Profile Button 68 |
|  Advanix Center Bend Preloaded RX Stent Systems 20 |  EndoVive One-Step Button™ and Low Profile Button Accessories..... 66, 68 |
|  Advanix Double Pigtail - Single Stent..... 22 |  EndoVive One-Step Button Low Profile PEG Kits 66 |
|  Advanix Duodenal Bend - Single Stent..... 21 |  EndoVive Safety PEGs..... 65 |
|  Advanix Duodenal Bend Preloaded RX Stent Systems..... 20 |  EndoVive Standard Balloon Replacements: Right-Angle 67 |
|  Advanix Pancreatic Stent - Straight, No Leading Barb..... 27 |  EndoVive Standard Balloon Replacements: Straight..... 67 |
|  Advanix Pancreatic Stent - Straight, Leading Barb..... 28 |  EndoVive Standard PEGs 65 |
|  Advanix Pancreatic Stent - Pigtail, No Leading Barb..... 29 |  EndoVive Through-the-PEG (TTP) Jejunal Feeding Tube (3-Port)... 67 |
|  Advanix Pancreatic Stent - Pigtail, Leading Barb 30 |  eXcelon™ Transbronchial Aspiration Needle..... 81 |
|  Advanix Pancreatic Stent Kit - Pigtail, Leading Barb and No Leading Barb 26 |  Expect™ Endoscopic Ultrasound Aspiration Needle..... 41 |
|  Advanix Pancreatic Stent Kit - Straight, No Leading Barb 26 |  Expect Slimline (SL) Endoscopic Ultrasound Aspiration Needle.. 41 |
|  Alair™ Bronchial Thermoplasty System 77 |  Extractor™ Pro DL Retrieval Balloons..... 33 |
|  Alliance™ II Inflation System..... 58, 83 |  Extractor Pro RX Retrieval Balloons – Distal Injection 32 |
|  Amplatz Super Stiff™ Guidewire..... 47 |  Extractor Pro RX Retrieval Balloons – Proximal Injection..... 32 |
|  Autotome™ RX Cannulating Sphincterotome 8 |  Extractor Pro XL Retrieval Balloons – Distal Injection..... 32 |
|  Biliary Introducer..... 24 |  Extractor Pro XL Retrieval Balloons – Proximal Injection 32 |
|  C-Flex™ Double Pigtail Biliary Stent 25 |  Flexima™ Duodenal Bend Biliary Stent with Delivery System.. 23 |
|  Captiflex™ Single-Use Snares 72 |  Flexima Single Pigtail Nasobiliary Catheter 25 |
|  Captivator™ II Single-Use Snare 73 |  Fluoro Tip™ ERCP Cannulas..... 13 |
|  Captivator Single-Use Snares 72 |  Gold Probe™ Single-Use Electrohemostasis Catheters..... 49 |
|  Cellebrity™ Single-Use Endoscopic Cytology Brush – Bronchoscope 82 |  Hurricane™ RX Biliary Balloon Dilatation Catheter 35 |
|  Contour™ ERCP Cannulas 13 |  Hydra Jagwire™ High Performance Guidewire 3 |
|  CRE™ Single-Use Fixed Wire Esophageal Balloon Dilators 55 |  Hydratome™ RX Cannulating Sphincterotome 6 |
|  CRE Single-Use Wireguided Biliary Balloon Dilators 34 |  Inflation / Deflation Devices and Accessories 58 |
|  CRE Single-Use Wireguided Esophageal / Pyloric / Balloon Dilators 55, 59 |  Initial Placement PEG Accessories..... 65 |
|  CRE Single-Use Wireguided Esophageal / Pyloric / Colonic / Biliary Balloon Dilators 56 |  Injection Gold Probe™ Single-Use Electrohemostasis / Injection Catheters..... 49 |
|  CRE Single-Use Wireguided Esophageal / Pyloric / Colonic / Balloon Dilators 59 |  Interject™ Clear Single-Use Injection Therapy Needle Catheters..... 50 |
|  CRE Single-Use Pulmonary Balloon Dilator 83 |  Interject Contrast Single-Use Injection Therapy Needle Catheters..... 50 |
|  Dreamtome™ RX Cannulating Sphincterotome 6 |  Jagtome™ RX Cannulating Sphincterotome..... 7 |
|  Dreamwire™ High Performance Guidewire 3 |  Jagwire™ High Performance Guidewire 4 |
|  Dynamic™ (Y) Stent 77 |  MaxForce TTS™ Esophageal High Performance Ballooon Dilatation Catheter 57 |
|  Electrosurgical Bipolar Cable Adapter 53 |  MaxForce™ Biliary Balloon Dilatation Catheter 36 |
|  Encore™ 26 Inflation Device..... 36 |  MicroKnife™ XL Triple-Lumen Needle Knife..... 10 |
|  Endostat™ Generator Accessories 52 |  Multibite™ Single-Use Multiple Sample Biopsy Forceps..... 63 |



*Product with this symbol may be used in Magnetic Resonance environment according to the conditions described in Directions for Use.

Note: RX devices are short wire devices.

 [Terms & Conditions](#)

Interactive Product Guide

| | |
|--|--|
| <ul style="list-style-type: none"> ▶ NaviFlex™ RX Delivery System 22 ▶ NaviFlex RX Pancreatic Delivery System & NaviFlex Pushers.... 31 ▶ NaviPro™ Hydrophilic Guidewire 5 ▶ Optiflo™ Single-Use Hemostasis Catheters..... 51 ▶ Pathfinder™ Exchange Guidewire 5 ▶ Percuflex™ Duodenal Bend Biliary Stent With Introducer Kit ... 24 ▶ Percuflex Duodenal Bend Biliary Stent 24 ▶ Polyflex™ Single-Use Esophageal Stent System 46 ▶ Polyflex Single-Use Self-Expanding Silicone Airway Stent System..... 80 ▶ Profile™ Single-Use Snares 74 ▶ Pulmonary Jagwire™ Pulmonary Guidewire..... 83 ▶ Radial Jaw™ 3 Single-Use Max Capacity Biopsy Forceps 87 ▶ Radial Jaw 4 Standard Capacity Single-Use Biopsy Forceps... 61 ▶ Radial Jaw 4 Single-Use Large Capacity Biopsy Forceps 61 ▶ Radial Jaw 4 Single-Use Hot Biopsy Forceps..... 62 ▶ Radial Jaw 4 Single-Use Jumbo Biopsy Forceps..... 61 ▶ Radial Jaw 4 Single-Use Pediatric Biopsy Forceps 62 ▶ Radial Jaw 4 Single-Use Pulmonary Biopsy Forceps 81 ▶ Rapid Exchange XL Cannula 12 ▶ Rapid Refill Continuous Injection System 14 ▶ Resolution™ Clip 49 ▶ Rigiflex™ II Single-Use Achalasia Balloon Dilators 57 ▶ RX Cholangiogram Kits 8 ▶ RX Cytology Brush Wireguided Cytology Brush..... 36 ▶ RX Duodenal Bend Biliary Stent with RX Delivery System 23 ▶ RX Locking Devices and Biopsy Cap Systems..... 14 ▶ RX Needle Knife XL Triple-Lumen Needle Knife 8 ▶ RX ERCP Cannulas 12 ▶ Sensation™ Single-Use Short Throw Snares..... 71 ▶ Single-Use Rotatable Snares 71 ▶ Speedband Superview Super 7™ Multiple Band Ligators..... 51 ▶ SpyBite™ Biopsy Forceps..... 39 ▶ SpyGlass™ Direct Visualization System – Disposable and Reusable Devices 39 ▶ SpyGlass Direct Visualization System – Capital Equipment 39 ▶ Stonetome™ Stone Removal Device..... 11 ▶ Tandem™ XL Triple-Lumen ERCP Cannula..... 13 | <ul style="list-style-type: none"> ▶ Trapezoid™ RX Wireguided Retrieval Baskets..... 33 ▶ TRUEtome™ Jag Cannulating Sphincterotome..... 9 ▶ TRUEtome Hydra Cannulating Sphincterotome 9 ▶ TRUEtome Dreamwire™ Cannulating Sphincterotome 9 ▶ TRUEtome Cannulating Sphincterotome..... 10 ▶ TWISTER® PLUS Rotatable Retrieval Device..... 74 ▶ Ultraflex™ Single-Use Covered Large Esophageal NG Stent System – Distal Release 47 ▶ Ultraflex Single-Use Covered Large Esophageal NG Stent System – Proximal Release..... 47 ▶ Ultraflex Single-Use Uncovered Esophageal NG Stent System – Distal Release..... 47 ▶ Ultraflex Single-Use Uncovered Esophageal NG Stent System – Proximal Release..... 47 ▶ Ultraflex Precision Single-Use Colonic Stent System..... 44 ▶ Ultraflex Single-Use Covered Esophageal NG Stent System – Distal Release..... 46 ▶ Ultraflex Single-Use Covered Esophageal NG Stent System – Proximal Release..... 46 ▶ Ultraflex Single-Use Uncovered Tracheobronchial Stent System – Distal Release..... 78 ▶ Ultraflex Single-Use Partially Covered Tracheobronchial Stent System – Distal Release 79 ▶ Ultraflex Single-Use Uncovered Tracheobronchial Stent System – Proximal Release..... 78 ▶ Ultratome™ Double-Lumen Sphincterotome 12 ▶ Ultratome RX Cannulating Sphincterotome..... 8 ▶ Ultratome XL Triple-Lumen Sphincterotome..... 11 ▶ WallFlex™ Biliary RX Fully Covered Stent System 17 ▶ WallFlex Biliary RX Partially Covered Stent System..... 17 ▶ WallFlex Biliary RX Uncovered Stent System 17 ▶ WallFlex Fully Covered Esophageal Stent 45 ▶ WallFlex Partially Covered Esophageal Stent..... 45 ▶ WallFlex Single-Use Colonic Stent System 43 ▶ WallFlex Single-Use Duodenal Stent System..... 43 ▶ WALLSTENT™ Endoscopic Biliary Endoprosthesis Stents 19 ▶ WALLSTENT RX Biliary Endoprosthesis Stent System..... 18 ▶ WALLSTENT Single-Use Colonic and Duodenal Endoprosthesis with UniStep™ Plus Delivery System..... 44 ▶ WALLSTENT Super Stiff Guidewire 44 ▶ Zero Tip™ Airway Retrieval Basket 82 |
|--|--|

Note: RX devices are short wire devices.

[▶ Terms & Conditions](#)

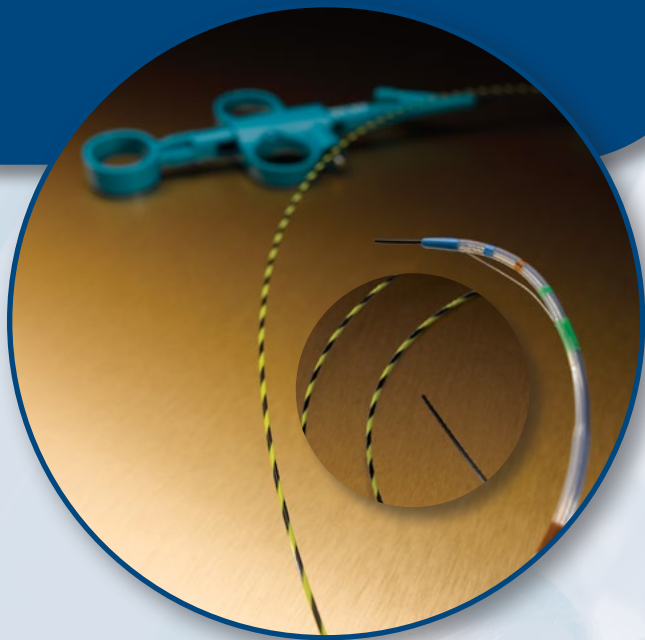

Biliary Access

Biliary Access

Guidewires

- Dreamwire™ High Performance Guidewire3
- Hydra Jagwire™ High Performance Guidewire3
- Jagtail™ High Performance Guidewire Extension4
- Jagwire™ High Performance Guidewire4
- NaviPro™ Hydrophilic Guidewire5
- Pathfinder™ Exchange Guidewire5

RX Preloaded Sphincterotomes

- Dreamtome™ RX Cannulating Sphincterotome
(Preloaded with Dreamwire High Performance Guidewire)6
- Hydratome™ RX Cannulating Sphincterotome
(Preloaded with Hydra Jagwire High Performance Guidewire).....6
- Jagtome™ RX Cannulating Sphincterotome
(Preloaded with Jagwire High Performance Guidewire)7

RX Sphincterotomes

- Autotome™ RX Cannulating Sphincterotome8
- RX Cholangiogram Kits8
- RX Needle Knife XL Triple-Lumen Needle Knife8
- Ultratome™ RX Cannulating Sphincterotome8

Preloaded Sphincterotomes

- TRUEtome™ Jag Cannulating Sphincterotome
(Preloaded with Jagwire High Performance Guidewire).....9
- TRUEtome Hydra Cannulating Sphincterotome
(Preloaded with Hydra Jagwire High Performance Guidewire)....9
- TRUEtome Dreamwire Cannulating Sphincterotome
(Preloaded with Dreamwire High Performance Guidewire)9

Sphincterotomes

- MicroKnife™ XL Triple-Lumen Needle Knife.....10
- Stonetome™ Stone Removal Device.....11
- TRUEtome Cannulating Sphincterotome.....10
- Ultratome Double-Lumen Sphincterotome12
- Ultratome XL Triple-Lumen Sphincterotome.....11

RX Cannulas

- Rapid Exchange XL Cannula12
- RX ERCP Cannulas12

Cannulas

- Contour™ ERCP Cannulas13
- Fluoro Tip™ ERCP Cannulas13
- Tandem™ XL Triple-Lumen ERCP Cannula.....13

Accessories

- Active Cords (Fits Boston Scientific
Endoscopy Sphincterotome)14
- RX Locking Devices and Biopsy Cap Systems.....14

Rapid Refill Continuous Injection System

- Rapid Refill Continuous Injection System14

Biliary

Guidewires

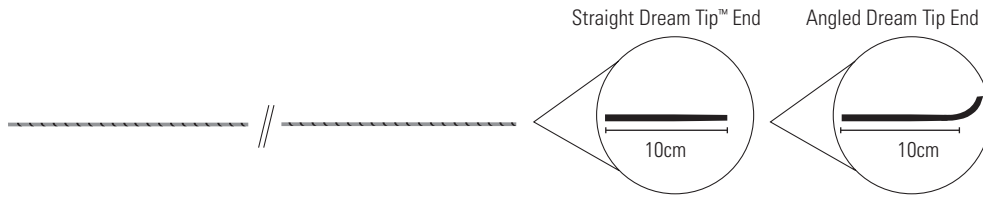

Dreamwire™ High Performance Guidewire



| Order Number | GTIN | Description | Distal Tip O.D. (in) | Working Length (cm) | Shaft Style | Dream Tip Style | Tip | Packaging |
|--------------|----------------|-------------------------------|----------------------|---------------------|-------------|-----------------|-------|-----------|
| M00556101 | 08714729777816 | Dreamwire Guidewire ST | .035 | 260 | Standard | Straight | Round | Box 2 |
| M00556111 | 08714729777847 | Dreamwire Guidewire ANG | .035 | 260 | Standard | Angled | Round | Box 2 |
| M00556121 | 08714729777830 | Dreamwire Guidewire ST Stiff | .035 | 260 | Stiff | Straight | Round | Box 2 |
| M00556131 | 08714729777823 | Dreamwire Guidewire ANG Stiff | .035 | 260 | Stiff | Angled | Round | Box 2 |
| M00556141 | 08714729777885 | Dreamwire Guidewire ST | .035 | 450 | Standard | Straight | Round | Box 2 |
| M00556151 | 08714729777878 | Dreamwire Guidewire ANG | .035 | 450 | Standard | Angled | Round | Box 2 |
| M00556161 | 08714729777861 | Dreamwire Guidewire ST Stiff | .035 | 450 | Stiff | Straight | Round | Box 2 |
| M00556171 | 08714729777854 | Dreamwire Guidewire ANG Stiff | .035 | 450 | Stiff | Angled | Round | Box 2 |

ST = Straight, ANG = Angled

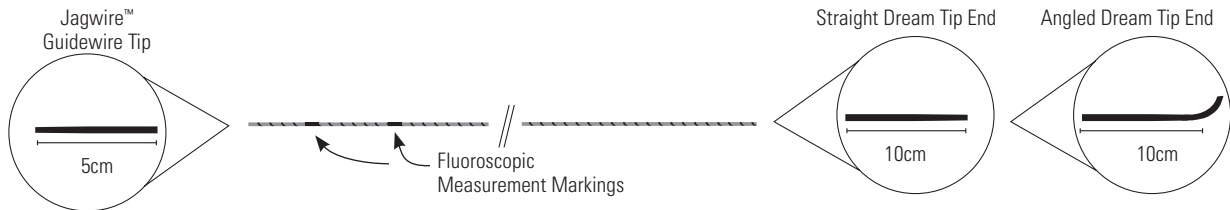

Hydra Jagwire™ High Performance Guidewire



| Order Number | GTIN | Description | Distal Tip O.D. (in) | Working Length (cm) | Shaft Style | Dream Tip Style | Tip | Packaging |
|--------------|----------------|-----------------------------------|----------------------|---------------------|-------------|-----------------|-------|-----------|
| M00556001 | 08714729648437 | Hydra Jagwire Guidewire ST | .035 | 260 | Standard | Straight | Round | Box 2 |
| M00556011 | 08714729648444 | Hydra Jagwire Guidewire ANG | .035 | 260 | Standard | Angled | Round | Box 2 |
| M00556021 | 08714729648451 | Hydra Jagwire Guidewire ST Stiff | .035 | 260 | Stiff | Straight | Round | Box 2 |
| M00556031 | 08714729648468 | Hydra Jagwire Guidewire ANG Stiff | .035 | 260 | Stiff | Angled | Round | Box 2 |
| M00556041 | 08714729648475 | Hydra Jagwire Guidewire ST | .035 | 450 | Standard | Straight | Round | Box 2 |
| M00556051 | 08714729648482 | Hydra Jagwire Guidewire ANG | .035 | 450 | Standard | Angled | Round | Box 2 |
| M00556061 | 08714729648499 | Hydra Jagwire Guidewire ST Stiff | .035 | 450 | Stiff | Straight | Round | Box 2 |
| M00556071 | 08714729648505 | Hydra Jagwire Guidewire ANG Stiff | .035 | 450 | Stiff | Angled | Round | Box 2 |

Hydra Jagwire Guidewire may remain in place during sphincterotomy. See Instructions for Use for details.

ST = Straight, ANG = Angled



Section Table of Contents

Prev Page

3

Next Page

Main Table of Contents



Biliary

Guidewires (Continued)

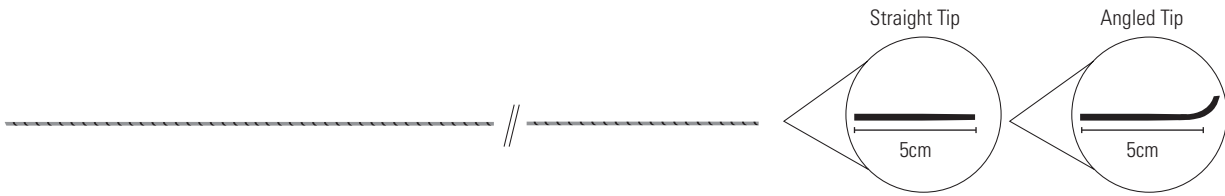

Jagwire™ High Performance Guidewire



| Order Number | GTIN | Description | Distal Tip O.D. (in) | Working Length (cm) | Shaft Style | Tip Style | Tip | Packaging |
|----------------------|----------------|--|----------------------|---------------------|-------------|---------------------|-------|-----------|
| NEW M00556511 | 08714729874492 | Jagwire Guidewire ANG | .025 | 450 | Standard | Angled | Round | Box 2 |
| NEW M00556521 | 08714729874508 | Jagwire Guidewire ST Stiff | .025 | 450 | Stiff | Straight | Round | Box 2 |
| NEW M00556531 | 08714729874515 | Jagwire Guidewire ANG Stiff | .025 | 450 | Stiff | Angled | Round | Box 2 |
| M00556561 | 08714729501374 | Jagwire Guidewire ST | .025 | 450 | Standard | Straight | Trim | Box 2 |
| M00556581 | 08714729339151 | Jagwire Guidewire ST | .035 | 450 | Standard | Straight | Trim | Box 2 |
| M00556591 | 08714729501398 | Jagwire Guidewire ANG | .035 | 450 | Standard | Angled | Trim | Box 2 |
| M00556601 | 08714729172154 | Jagwire Guidewire ST Stiff | .035 | 450 | Stiff | Straight | Trim | Box 2 |
| M00556611 | 08714729172161 | Jagwire Guidewire ANG Stiff | .035 | 450 | Stiff | Angled | Trim | Box 2 |
| M00556621 | 08714729172178 | Jagwire Guidewire ST | .038 | 260 | Standard | Straight | Trim | Box 2 |
| M00556631 | 08714729172185 | Jagwire Guidewire ST Stiff | .035 | 260 | Stiff | Straight | Trim | Box 2 |
| M00556641 | 08714729172192 | Jagwire Guidewire ST | .035 | 260 | Standard | Straight | Trim | Box 2 |
| M00556651 | 08714729172208 | Jagwire Guidewire ANG | .035 | 260 | Standard | Angled | Trim | Box 2 |
| M00556661 | 08714729172215 | Jagwire Guidewire ANG Stiff | .035 | 260 | Stiff | Angled | Trim | Box 2 |
| M00556461 | 08714729415183 | Jagwire Guidewire ST | .025 | 260 | Standard | Straight | Round | Box 2 |
| M00556481 | 08714729415190 | Jagwire Guidewire ST Stiff | .025 | 260 | Stiff | Straight | Round | Box 2 |
| M00556491 | 08714729415206 | Jagwire Guidewire ANG Stiff | .025 | 260 | Stiff | Angled | Round | Box 2 |
| M00556841 | 08714729268680 | Extendable Jagwire Guidewire ST | .035 | 260 | Standard | Straight | Round | Box 2 |
| M00556851 | 08714729268697 | Extendable Jagwire Guidewire ANG | .035 | 260 | Standard | Angled | Round | Box 2 |
| M00556861 | 08714729268703 | Extendable Jagwire Guidewire ST Stiff | .035 | 260 | Stiff | Straight | Round | Box 2 |
| M00556871 | 08714729268710 | Extendable Jagwire Guidewire ANG Stiff | .035 | 260 | Stiff | Angled | Round | Box 2 |
| M00556902 | 08714729268734 | Jagtail™ Guidewire Extension | .035 | 200 | – | Guidewire extension | – | Box 5 |

Jagwire Guidewire may remain in place during sphincterotomy. See Instructions for Use for details.
ST = Straight, ANG = Angled

Biliary

Guidewires (Continued)

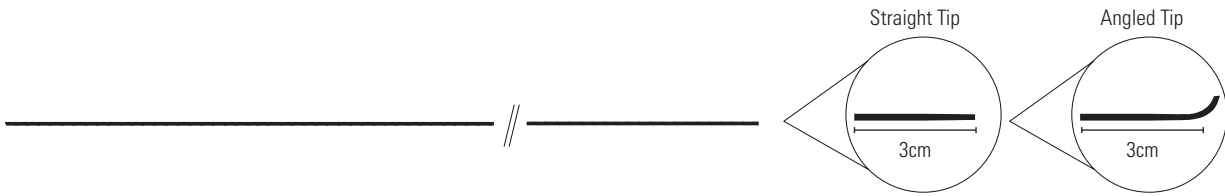

NaviPro™ Hydrophilic Guidewire

| Order Number | GTIN | Description | Guidewire Diameter (in) | Length (cm) | Shaft Style | Tip Style | Packaging |
|--------------|----------------|-------------------------------|-------------------------|-------------|-------------|-----------|-----------|
| M00556191 | 08714729839873 | NaviPro Hydrophilic Guidewire | 0.018 | 260 | Standard | Angled | Box 5 |
| M00556181 | 08714729839866 | NaviPro Hydrophilic Guidewire | 0.018 | 260 | Standard | Straight | Box 5 |
| M00556211 | 08714729839897 | NaviPro Hydrophilic Guidewire | 0.025 | 260 | Standard | Angled | Box 5 |
| M00556201 | 08714729839880 | NaviPro Hydrophilic Guidewire | 0.025 | 260 | Standard | Straight | Box 5 |
| M00556231 | 08714729839910 | NaviPro Hydrophilic Guidewire | 0.035 | 260 | Standard | Angled | Box 5 |
| M00556221 | 08714729839903 | NaviPro Hydrophilic Guidewire | 0.035 | 260 | Standard | Straight | Box 5 |
| M00556251 | 08714729839934 | NaviPro Hydrophilic Guidewire | 0.035 | 260 | Stiff | Angled | Box 5 |
| M00556241 | 08714729839927 | NaviPro Hydrophilic Guidewire | 0.035 | 260 | Stiff | Straight | Box 5 |

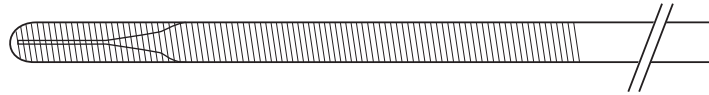

Pathfinder™ Exchange Guidewire



| Order Number | GTIN | Description | Distal Tip O.D. (in) | Working Length (cm) | Tip Style | Tip Length (cm) | Packaging |
|--------------|----------------|--|----------------------|---------------------|-----------|-----------------|-----------|
| M00551591 | 08714729156116 | Pathfinder Exchange Guidewire Stiff Shaft | .018 | 450 | Shapeable | 6.5 | Box 2 |

Biliary

RX Preloaded Sphincterotome

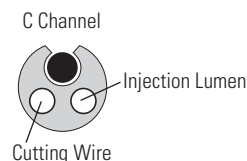
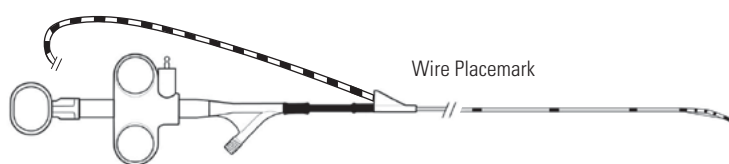

Dreamtome™ RX Cannulating Sphincterotome (Preloaded with Dreamwire™ High Performance Guidewire)



| Order Number | GTIN | Description | Tip Length (mm) | Cut Wire Length (mm) | Preloaded Guidewire (in / cm) | Guidewire Tip Style | Packaging |
|--------------|----------------|--------------------------------|-----------------|----------------------|--------------------------------|---------------------|-----------|
| M00584000 | 08714729778226 | Dreamtome RX 49 Sphincterotome | 5 | 20 | .035 / 260 Dreamwire Guidewire | Straight | Each |
| M00584010 | 08714729778233 | Dreamtome RX 49 Sphincterotome | 5 | 30 | .035 / 260 Dreamwire Guidewire | Straight | Each |
| M00584020 | 08714729778240 | Dreamtome RX 49 Sphincterotome | 5 | 20 | .035 / 450 Dreamwire Guidewire | Straight | Each |
| M00584030 | 08714729778257 | Dreamtome RX 49 Sphincterotome | 5 | 30 | .035 / 450 Dreamwire Guidewire | Straight | Each |
| M00584040 | 08714729778264 | Dreamtome RX 44 Sphincterotome | 5 | 20 | .035 / 260 Dreamwire Guidewire | Straight | Each |
| M00584050 | 08714729778271 | Dreamtome RX 44 Sphincterotome | 5 | 30 | .035 / 260 Dreamwire Guidewire | Straight | Each |
| M00584060 | 08714729778288 | Dreamtome RX 44 Sphincterotome | 5 | 20 | .035 / 450 Dreamwire Guidewire | Straight | Each |
| M00584070 | 08714729778295 | Dreamtome RX 44 Sphincterotome | 5 | 30 | .035 / 450 Dreamwire Guidewire | Straight | Each |

*Preloaded with straight-tip guidewires only.
Active Cords sold separately [▶](#) (Click here to view page 14).

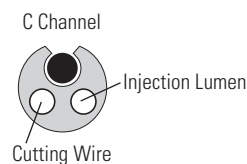
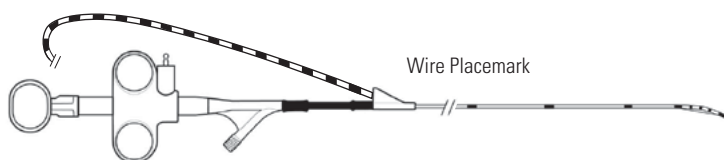

Hydratome™ RX Cannulating Sphincterotome (Preloaded with Hydra Jagwire™ High Performance Guidewire)



| Order Number | GTIN | Description | Cut Wire (mm) | Tip Length (mm) | Distal Tip O.D. (Fr) | Preloaded Guidewire (cm) | Guidewire Tip Style | Packaging |
|--------------|----------------|--------------------------------|---------------|-----------------|----------------------|-----------------------------|---------------------|-----------|
| M00583000 | 08714729755159 | Hydratome RX 49 Sphincterotome | 20 | 5 | 4.9 | 260 Hydra Jagwire Guidewire | Straight | Each |
| M00583010 | 08714729755166 | Hydratome RX 49 Sphincterotome | 30 | 5 | 4.9 | 260 Hydra Jagwire Guidewire | Straight | Each |
| M00583020 | 08714729755173 | Hydratome RX 49 Sphincterotome | 20 | 5 | 4.9 | 450 Hydra Jagwire Guidewire | Straight | Each |
| M00583030 | 08714729755180 | Hydratome RX 49 Sphincterotome | 30 | 5 | 4.9 | 450 Hydra Jagwire Guidewire | Straight | Each |
| M00583040 | 08714729755197 | Hydratome RX 44 Sphincterotome | 20 | 5 | 4.4 | 260 Hydra Jagwire Guidewire | Straight | Each |
| M00583050 | 08714729755203 | Hydratome RX 44 Sphincterotome | 30 | 5 | 4.4 | 260 Hydra Jagwire Guidewire | Straight | Each |
| M00583060 | 08714729755210 | Hydratome RX 44 Sphincterotome | 20 | 5 | 4.4 | 450 Hydra Jagwire Guidewire | Straight | Each |
| M00583070 | 08714729755227 | Hydratome RX 44 Sphincterotome | 30 | 5 | 4.4 | 450 Hydra Jagwire Guidewire | Straight | Each |

Active Cords sold separately [▶](#) (Click here to view page 14).



Section Table of Contents

Prev Page

6

Next Page

Main Table of Contents



Biliary

RX Preloaded Sphincterotome (Continued)



Jagtome™ RX Cannulating Sphincterotome (Preloaded with Jagwire™ High Performance Guidewire)



| Order Number | GTIN | Description | Cut Wire (mm) | Tip Length (mm) | Distal Tip O.D. (Fr) | Preloaded Guidewire (in / cm) | Guidewire Tip Style | Packaging |
|--------------|----------------|------------------------------|---------------|-----------------|----------------------|-------------------------------|---------------------|-----------|
| M00573000 | 08714729776710 | Jagtome RX 49 Sphincterotome | 20 | 5 | 4.9 | .035 / 260 Jagwire Guidewire | Straight | Each |
| M00573010 | 08714729776727 | Jagtome RX 49 Sphincterotome | 20 | 5 | 4.9 | .035 / 450 Jagwire Guidewire | Straight | Each |
| M00573020 | 08714729776734 | Jagtome RX 49 Sphincterotome | 30 | 5 | 4.9 | .035 / 260 Jagwire Guidewire | Straight | Each |
| M00573030 | 08714729776741 | Jagtome RX 49 Sphincterotome | 30 | 5 | 4.9 | .035 / 450 Jagwire Guidewire | Straight | Each |
| M00573040 | 08714729776659 | Jagtome RX 44 Sphincterotome | 20 | 5 | 4.4 | .035 / 260 Jagwire Guidewire | Straight | Each |
| M00573050 | 08714729776666 | Jagtome RX 44 Sphincterotome | 20 | 5 | 4.4 | .035 / 450 Jagwire Guidewire | Straight | Each |
| M00573060 | 08714729776673 | Jagtome RX 44 Sphincterotome | 30 | 5 | 4.4 | .035 / 260 Jagwire Guidewire | Straight | Each |
| M00573070 | 08714729776543 | Jagtome RX 44 Sphincterotome | 30 | 5 | 4.4 | .035 / 450 Jagwire Guidewire | Straight | Each |
| M00573080 | 08714729776642 | Jagtome RX 39 Sphincterotome | 20 | 5 | 3.9 | .025 / 260 Jagwire Guidewire | Straight | Each |
| M00573090 | 08714729776550 | Jagtome RX 39 Sphincterotome | 20 | 5 | 3.9 | .025 / 450 Jagwire Guidewire | Straight | Each |
| M00573100 | 08714729776536 | Jagtome RX 39 Sphincterotome | 30 | 5 | 3.9 | .025 / 260 Jagwire Guidewire | Straight | Each |
| M00573110 | 08714729776529 | Jagtome RX 39 Sphincterotome | 30 | 5 | 3.9 | .025 / 450 Jagwire Guidewire | Straight | Each |

Active Cords sold separately [▶](#) (Click here to view page 14).

Biliary

RX Sphincterotome

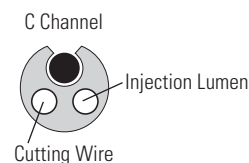

Autotome™ RX Cannulating Sphincterotome ⓧ

| Order Number | GTIN | Description | Cut Wire (mm) | Tip Length (mm) | Distal Tip O.D. (Fr) | Recommended Guidewire (in) | Packaging |
|--------------|----------------|---|---------------|-----------------|----------------------|----------------------------|-----------|
| M00545150 | 08714729415138 | Autotome RX 49 Cannulating Sphincterotome | 20 | 5 | 4.9 | .035 | Each |
| M00545160 | 08714729415152 | Autotome RX 49 Cannulating Sphincterotome | 30 | 5 | 4.9 | .035 | Each |
| M00545170 | 08714729444749 | Autotome RX 44 Cannulating Sphincterotome | 20 | 5 | 4.4 | .035 | Each |
| M00545180 | 08714729444756 | Autotome RX 44 Cannulating Sphincterotome | 30 | 5 | 4.4 | .035 | Each |
| M00545190 | 08714729444763 | Autotome RX 39 Cannulating Sphincterotome | 20 | 5 | 3.9 | .025 | Each |
| M00545200 | 08714729444770 | Autotome RX 39 Cannulating Sphincterotome | 30 | 5 | 3.9 | .025 | Each |

Active Cords sold separately [▶](#) (Click here to view page 14).

Ultratome™ RX Cannulating Sphincterotome ⓧ

| Order Number | GTIN | Description | Cut Wire (mm) | Tip Length (mm) | Distal Tip O.D. (Fr) | Recommended Guidewire (in) | Packaging |
|--------------|----------------|---|---------------|-----------------|----------------------|----------------------------|-----------|
| M00545050 | 08714729251903 | Ultratome RX Cannulating Sphincterotome, Short Nose | 20 | 5 | 5.5 | .035 | Each |
| M00545060 | 08714729251927 | Ultratome RX Cannulating Sphincterotome, Short Nose | 30 | 5 | 5.5 | .035 | Each |

Active Cords sold separately [▶](#) (Click here to view page 14).

RX Cholangiogram Kits* ⓧ

| Order Number | Description | Sphincterotome | Guidewire | Accessory |
|--------------|-----------------------------|---|--------------------|-------------------|
| M005XXXX1 | Cholangiogram Kit | Autotome or Ultratome XL Sphincterotome | Jagwire™ Guidewire | N / A |
| M005XXXX1 | Cholangiogram Kit-Preloaded | Autotome Sphincterotome | Jagwire Guidewire | RX Locking Device |

*To order RX Cholangiogram Kits please contact your local Boston Scientific Endoscopy Sales Representative.

RX Needle Knife XL Triple-Lumen Needle Knife ⓧ

| Order Number | GTIN | Description | Length (cm) | Cut Wire (mm) | Distal Tip O.D. (Fr) | Recommended Guidewire (in) | Packaging |
|--------------|----------------|-----------------|-------------|---------------|----------------------|----------------------------|-----------|
| M00545840 | 08714729283799 | RX Needle Knife | 200 | 5 | 5.5 | .035 | Each |

Biliary

Sphincterotome

TRUEtome™ Jag Cannulating Sphincterotome (Preloaded with Jagwire™ High Performance Guidewire)

| Order Number | GTIN | Description | Tip Length (mm) | Cut Wire Length (mm) | Preloaded Guidewire (in / cm) | Tip O.D. (Fr) | Packaging |
|--------------|----------------|----------------------------|-----------------|----------------------|------------------------------------|---------------|-----------|
| M00583080 | 08714729858621 | TRUEtome 39 Sphincterotome | 5 | 20 | .025 / 450 Jagwire Guidewire | 3.9 | Each |
| M00583090 | 08714729858638 | TRUEtome 44 Sphincterotome | 5 | 20 | .025 / 450 Jagwire Guidewire | 4.4 | Each |
| M00583100 | 08714729858645 | TRUEtome 44 Sphincterotome | 5 | 20 | .035 / 450 Jagwire Guidewire | 4.4 | Each |
| M00583110 | 08714729858652 | TRUEtome 44 Sphincterotome | 5 | 20 | .035 / Stiff 450 Jagwire Guidewire | 4.4 | Each |
| M00583120 | 08714729858669 | TRUEtome 39 Sphincterotome | 5 | 30 | .025 / 450 Jagwire Guidewire | 3.9 | Each |
| M00583130 | 08714729858676 | TRUEtome 44 Sphincterotome | 5 | 30 | .025 / 450 Jagwire Guidewire | 4.4 | Each |
| M00583140 | 08714729858683 | TRUEtome 44 Sphincterotome | 5 | 30 | .035 / 450 Jagwire Guidewire | 4.4 | Each |
| M00583150 | 08714729858690 | TRUEtome 44 Sphincterotome | 5 | 30 | .035 / Stiff 450 Jagwire Guidewire | 4.4 | Each |

TRUEtome Hydra Cannulating Sphincterotome (Preloaded with Hydra Jagwire™ High Performance Guidewire)

| | | | | | | | |
|-----------|----------------|----------------------------|---|----|------------------------------------|-----|------|
| M00583160 | 08714729858706 | TRUEtome 44 Sphincterotome | 5 | 20 | .035 / 450 Hydra Jagwire Guidewire | 4.4 | Each |
| M00583170 | 08714729858713 | TRUEtome 44 Sphincterotome | 5 | 30 | .035 / 450 Hydra Jagwire Guidewire | 4.4 | Each |

TRUEtome Dreamwire™ Cannulating Sphincterotome (Preloaded with Dreamwire High Performance Guidewire)

| | | | | | | | |
|-----------|----------------|----------------------------|---|----|--------------------------------|-----|------|
| M00583180 | 08714729858720 | TRUEtome 44 Sphincterotome | 5 | 20 | .035 / 260 Dreamwire Guidewire | 4.4 | Each |
| M00583190 | 08714729858737 | TRUEtome 44 Sphincterotome | 5 | 20 | .035 / 450 Dreamwire Guidewire | 4.4 | Each |
| M00583200 | 08714729858744 | TRUEtome 44 Sphincterotome | 5 | 30 | .035 / 260 Dreamwire Guidewire | 4.4 | Each |
| M00583210 | 08714729858751 | TRUEtome 44 Sphincterotome | 5 | 30 | .035 / 450 Dreamwire Guidewire | 4.4 | Each |

*Preloaded with straight-tip guidewires only.
Active Cords sold separately  (Click here to view page 14).

Biliary

Sphincterotome (Continued)

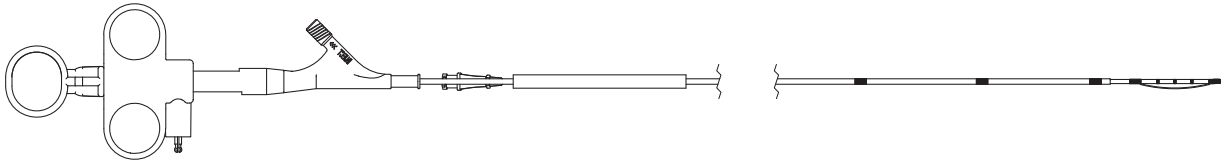

TRUEtome™ Cannulating Sphincterotome



| Order Number | GTIN | Description | Cut Wire Length (mm) | Tip Length (mm) | Distal Tip O.D. (Fr) | Recommended Guidewire (in) | Packaging |
|--------------|----------------|----------------------------|----------------------|-----------------|----------------------|----------------------------|-----------|
| M00584190 | 08714729827658 | TRUEtome 39 Sphincterotome | 20 | 5 | 3.9 | .025 | Each |
| M00584120 | 08714729827771 | TRUEtome 39 Sphincterotome | 30 | 5 | 3.9 | .025 | Each |
| M00584170 | 08714729827634 | TRUEtome 44 Sphincterotome | 20 | 5 | 4.4 | .035 | Each |
| M00584180 | 08714729827641 | TRUEtome 44 Sphincterotome | 30 | 5 | 4.4 | .035 | Each |
| M00584150 | 08714729827610 | TRUEtome 49 Sphincterotome | 20 | 5 | 4.9 | .035 | Each |
| M00584160 | 08714729827627 | TRUEtome 49 Sphincterotome | 30 | 5 | 4.9 | .035 | Each |

Active Cords sold separately [▶ \(Click here to view page 14\).](#)

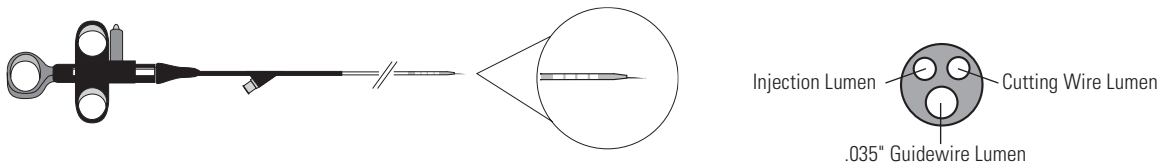

MicroKnife™ XL Triple-Lumen Needle Knife



| Order Number | GTIN | Description | Shaft O.D. (Fr) | Catheter Length (cm) | Recommended Guidewire (in) | Packaging |
|--------------|----------------|---|-----------------|----------------------|----------------------------|-----------|
| M00532810 | 08714729172017 | MicroKnife XL Triple-Lumen Needle Knife | 7.0 - 5.5 | 200 | .035 | Each |

Active Cords sold separately [▶ \(Click here to view page 14\).](#)

Biliary

Sphincterotome (Continued)

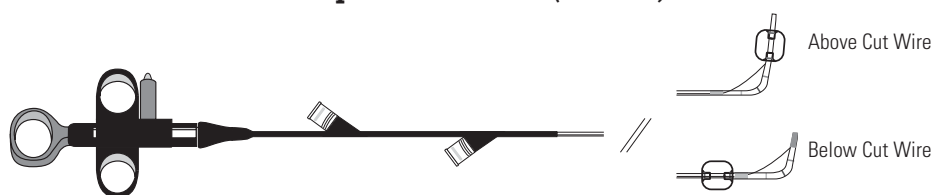

Stonetome™ Stone Removal Device



| Order Number | GTIN | Description | Balloon Diameter (mm) | Catheter Length (cm) | Tip Length (mm) | Cut Wire (mm) | Distal Tip O.D. (Fr) | Recommended Guidewire (in) | Packaging |
|--------------|----------------|-----------------------------------|-----------------------|----------------------|-----------------|---------------|----------------------|----------------------------|-----------|
| M00535150 | 08714729146667 | Stonetome Device (below cut wire) | 11.5 | 200 | 5 | 20 | 5.5 | .035 | Each |
| M00535170 | 08714729146629 | Stonetome Device (below cut wire) | 11.5 | 200 | 20 | 20 | 5.5 | .035 | Each |
| M00535190 | 08714729146612 | Stonetome Device (below cut wire) | 11.5 | 200 | 5 | 30 | 5.5 | .035 | Each |
| M00535210 | 08714729146605 | Stonetome Device (below cut wire) | 11.5 | 200 | 20 | 30 | 5.5 | .035 | Each |
| M00535110 | 08714729146599 | Stonetome Device (above cut wire) | 11.5 | 200 | 20 | 20 | 5.5 | .035 | Each |
| M00535130 | 08714729146575 | Stonetome Device (above cut wire) | 11.5 | 200 | 20 | 30 | 5.5 | .035 | Each |

Active Cords sold separately [▶](#) (Click here to view page 14).

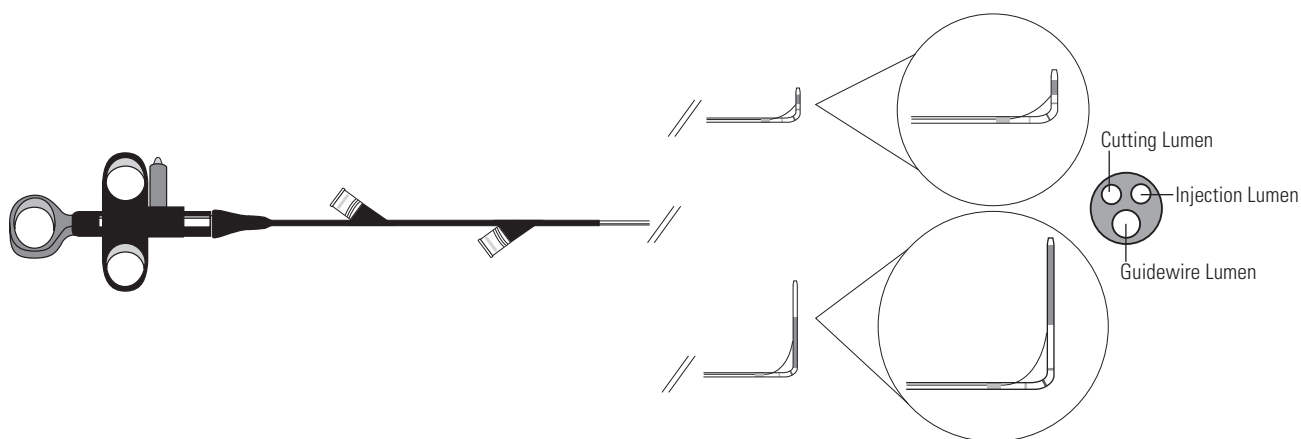

Ultratome™ XL Triple-Lumen Sphincterotome



| Order Number | GTIN | Description | Wire Length (mm) | Shaft O.D. (Fr) | Catheter Length (cm) | Tip Length (mm) | Recommended Guidewire (in) | Packaging |
|--------------|----------------|--|------------------|-----------------|----------------------|-----------------|----------------------------|-----------|
| M00535900 | 08714729103257 | Ultratome XL Short Nose Sphincterotome | 20 | 5.5 | 200 | 5 | .035 | Each |
| M00535910 | 08714729103301 | Ultratome XL Long Nose Sphincterotome | 20 | 5.5 | 200 | 20 | .035 | Each |
| M00535920 | 08714729103318 | Ultratome XL Short Nose Sphincterotome | 30 | 5.5 | 200 | 5 | .035 | Each |
| M00535930 | 08714729103349 | Ultratome XL Long Nose Sphincterotome | 30 | 5.5 | 200 | 20 | .035 | Each |

Active Cords sold separately [▶](#) (Click here to view page 14).



Section Table of Contents

Prev Page [◀](#) 11 [▶](#) Next Page

Main Table of Contents



Biliary

Sphincterotome (Continued)

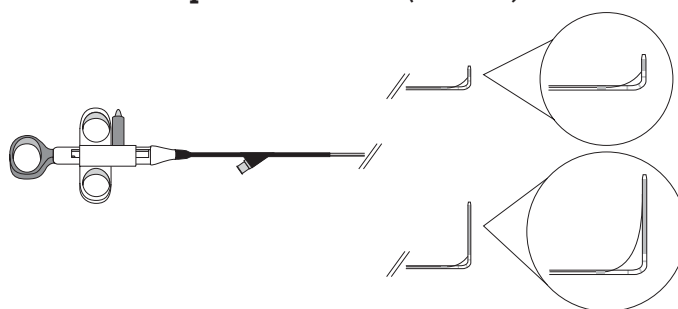

Ultratome™ Double-Lumen Sphincterotome



| Order Number | GTIN | Description | Wire Length (mm) | Distal Tip O.D. | | Catheter Length (cm) | Tip Length (mm) | Recommended Guidewire (in) | Packaging |
|--------------|----------------|-------------------------------------|------------------|-----------------|------|----------------------|-----------------|----------------------------|-----------|
| | | | | (mm) | (Fr) | | | | |
| M00530800 | 08714729163664 | Ultratome Short Nose Sphincterotome | 20 | 1.8 | 5.5 | 200 | 5 | .035 | Each |
| M00530810 | 08714729183143 | Ultratome Long Nose Sphincterotome | 20 | 1.8 | 5.5 | 200 | 20 | .035 | Each |
| M00530820 | 08714729193418 | Ultratome Short Nose Sphincterotome | 30 | 1.8 | 5.5 | 200 | 5 | .035 | Each |
| M00530830 | 08714729193425 | Ultratome Long Nose Sphincterotome | 30 | 1.8 | 5.5 | 200 | 20 | .035 | Each |

Active Cords sold separately (Click here to view page 14).

RX Cannulas

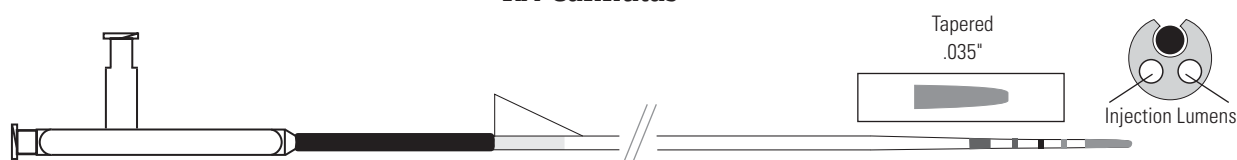

Rapid Exchange XL Cannula



| Order Number | GTIN | Description | Working Length (cm) | Tip Style | Recommended Guidewire (in) | Packaging |
|--------------|----------------|---------------------------|---------------------|-----------|----------------------------|-----------|
| M00545820 | 08714729301905 | Rapid Exchange XL Cannula | 195 | Tapered | .035 | Each |

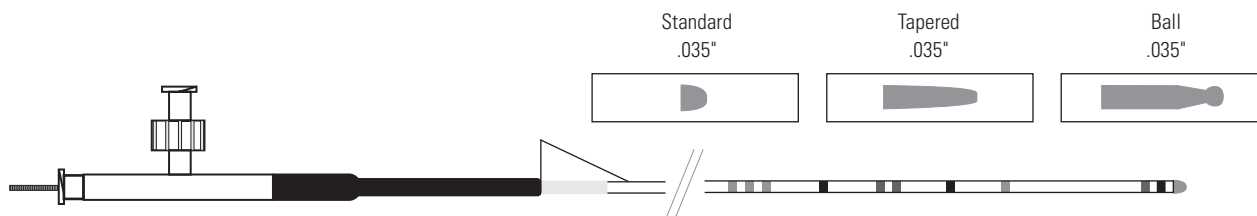

RX ERCP Cannulas



| Order Number | GTIN | Description | Working Length (cm) | Recommended Guidewire (in) | Packaging |
|--------------|----------------|------------------------------|---------------------|----------------------------|-----------|
| M00545760 | 08714729268642 | RX ERCP Cannula Standard Tip | 210 | .035 | Each |
| M00545770 | 08714729268659 | RX ERCP Cannula Tapered Tip | 210 | .035 | Each |
| M00545780 | 08714729268673 | RX ERCP Cannula Ball Tip | 210 | .035 | Each |



Section Table of Contents

Prev Page 12 Next Page

Main Table of Contents



Biliary

Cannulas

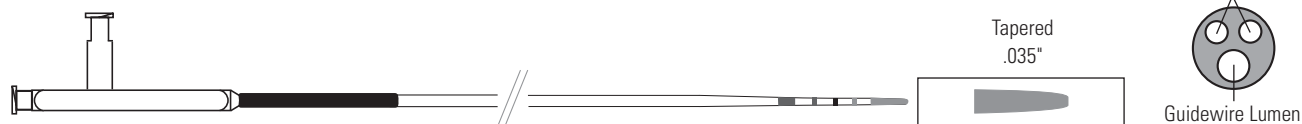

Tandem™ XL Triple-Lumen ERCP Cannula



| Order Number | GTIN | Distal Tip O.D. | | Catheter Size (Fr) | Working Length (cm) | Tip Style | Recommended Guidewire (in) | Packaging |
|--------------|----------------|-----------------|------|--------------------|---------------------|-----------|----------------------------|-----------|
| | | (Fr) | (mm) | | | | | |
| M00535700 | 08714729146636 | 5.5 | 1.8 | 7.0 – 5.5 | 200 | Tapered | .035 | Each |

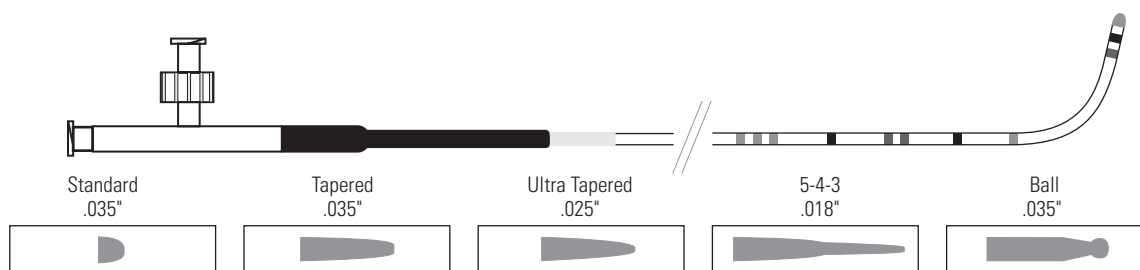

Contour™ ERCP Cannulas



| Order Number | GTIN | Description | Distal Tip O.D. | | Working Length (cm) | Tip Style | Recommended Guidewire (in) | Packaging |
|--------------|----------------|----------------------|-----------------|------|---------------------|---------------|----------------------------|-----------|
| | | | (Fr) | (mm) | | | | |
| M00530850 | 08714729099789 | Contour ERCP Cannula | 5 | 1.7 | 210 | Standard | .035 | Each |
| M00530860 | 08714729099819 | Contour ERCP Cannula | 5 | 1.7 | 210 | Tapered | .035 | Each |
| M00530870 | 08714729099826 | Contour ERCP Cannula | 5 | 1.7 | 210 | Ultra Tapered | .025 | Each |
| M00530880 | 08714729099833 | Contour ERCP Cannula | 5 | 1.7 | 210 | 5-4-3 | .018 | Each |
| M00530890 | 08714729099840 | Contour ERCP Cannula | 5 | 1.7 | 210 | Ball Tip | .035 | Each |

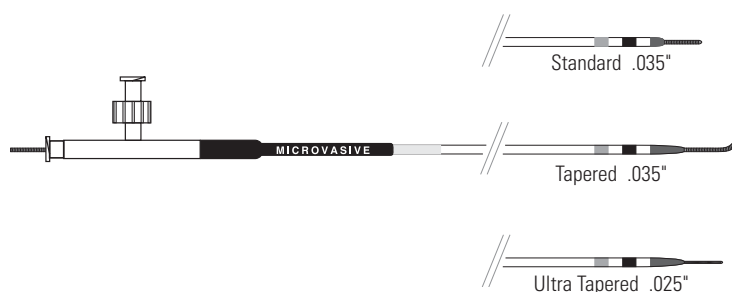

Fluoro Tip™ ERCP Cannulas



| Order Number | GTIN | Description | Distal Tip O.D. | | Working Length (cm) | Recommended Guidewire (in) | Packaging |
|--------------|----------------|---|-----------------|------|---------------------|----------------------------|-----------|
| | | | (mm) | (Fr) | | | |
| M00530960 | 08714729172277 | Fluoro Tip ERCP Cannula Standard Tip | 1.7 | 5 | 210 | .035 | Each |
| M00530970 | 08714729172284 | Fluoro Tip ERCP Cannula Tapered Tip | 1.7 | 5 | 210 | .035 | Each |
| M00530980 | 08714729193432 | Fluoro Tip ERCP Cannula Ultra Tapered Tip | 1.7 | 5 | 210 | .025 | Each |



Biliary

Accessories

RX Locking Devices and Biopsy Cap Systems

| Order Number | GTIN | Description | Packaging |
|--------------|----------------|--|-----------|
| M00545471 | 08714729337768 | RX Locking Device (Biopsy Cap not included) | Box 10 |
| M00545211 | 08714729440604 | RX Locking Device – Olympus™ / Fujinon™ Brand Endoscope Compatible | Box 10 |
| M00545261 | 08714729296614 | RX Locking Device and Biopsy Cap System – Olympus Brand Endoscope Compatible | Box 10 |
| M00545271 | 08714729296621 | RX Locking Device and Biopsy Cap System – Pentax™ Brand Endoscope Compatible | Box 10 |
| M00545281 | 08714729296638 | RX Locking Device and Biopsy Cap System – Fujinon Brand Endoscope Compatible | Box 10 |

Active Cords (Fit Boston Scientific Endoscopy Sphincterotome)

| Order Number | Description | Packaging |
|--------------|---|-----------|
| M00561250 | Active Cord, Fits Olympus Brand Generator | Each |
| M00561270 | Active Cord, Fits Endostat™, Endostat II and Endostat III Generators, Bovie™, Valleylab™, Aspen Labs™, and ERBE™ Brand Generators | Each |

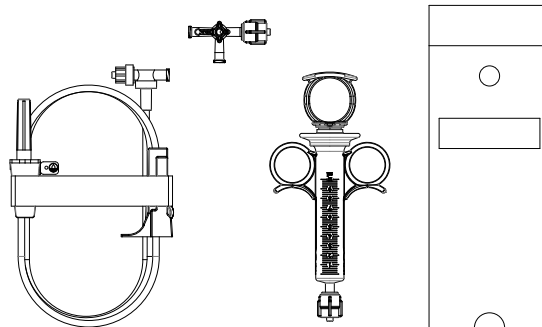

Rapid Refill Continuous Injection System



| Order Number | GTIN | Description | Packaging |
|--------------|----------------|--|-----------|
| M00566001 | 08714729285151 | Rapid Refill Continuous Injection System | Box 10 |

Notes and Future Product Updates

Notes and Future Product Updates

Blank lined area for notes and future product updates.



Biliary Devices

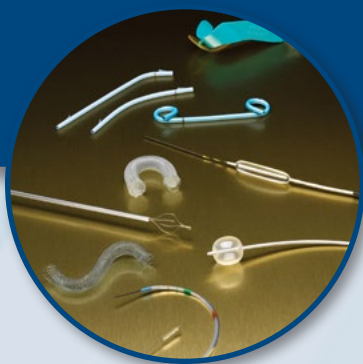

Biliary and Pancreatic Stents

Biliary Metal Stent Systems

- ▶ WallFlex™ Biliary RX Fully Covered Stent System17
- ▶ WallFlex Biliary RX Partially Covered Stent System.....17
- ▶ WallFlex Biliary RX Uncovered Stent System17
- ▶ WALLSTENT™ RX Biliary Endoprosthesis Stent System.....18
- ▶ WALLSTENT Endoscopic Biliary Endoprosthesis Stents19

Biliary Plastic Stents

- ▶ Advanix™ Center Bend Preloaded RX Stent Systems.....20
- ▶ Advanix Center Bend - Single Stent.....21
- ▶ Advanix Double Pigtail - Single Stent.....22
- ▶ Advanix Duodenal Bend Preloaded RX Stent Systems.....20
- ▶ Advanix Duodenal Bend - Single Stent.....21
- ▶ Biliary Introducer.....24
- ▶ C-Flex™ Double Pigtail Biliary Stent25
- ▶ Flexima™ Duodenal Bend Biliary Stent with Delivery System.....23
- ▶ Flexima Single Pigtail Nasobiliary Catheter25
- ▶ NaviFlex™ RX Delivery System22
- ▶ Percuflex™ Duodenal Bend Biliary Stent.....24
- ▶ Percuflex Duodenal Bend Biliary Stent with Introducer Kit.....24
- ▶ RX Duodenal Bend Biliary Stent with RX Delivery System23

Pancreatic Plastic Stents

- ▶ Advanix Pancreatic Stent Kit - Straight, No Leading Barb26
- ▶ Advanix Pancreatic Stent Kit - Pigtail, Leading Barb and No Leading Barb26

- ▶ Advanix Pancreatic Stent - Straight, No Leading Barb.....27
- ▶ Advanix Pancreatic Stent - Straight, Leading Barb.....28
- ▶ Advanix Pancreatic Stent - Pigtail, No Leading Barb.....29
- ▶ Advanix Pancreatic Stent - Pigtail, Leading Barb30
- ▶ NaviFlex RX Pancreatic Delivery System & NaviFlex Pushers31

Biliary Stone Management

RX Stone Management

- ▶ Extractor™ Pro RX Retrieval Balloons – Distal Injection32
- ▶ Extractor Pro RX Retrieval Balloons – Proximal Injection.....32

Stone Management

- ▶ Extractor Pro DL Retrieval Balloons.....33
- ▶ Extractor Pro XL Retrieval Balloons – Distal Injection.....32
- ▶ Extractor Pro XL Retrieval Balloons – Proximal Injection32
- ▶ Trapezoid™ RX Wireguided Retrieval Baskets.....33

CRE™ Balloon Dilators

- ▶ CRE Single-Use Wireguided Biliary Balloon Dilators34

Biliary Stricture Management

RX Dilatation

- ▶ Hurricane™ RX Biliary Balloon Dilatation Catheter35

Biliary Dilatation

- ▶ MaxForce™ Biliary Balloon Dilatation Catheter36

RX Accessories

- ▶ Encore™ 26 Inflation Device.....36

RX Cytology

- ▶ RX Cytology Brush Wireguided Cytology Brush.....36



Biliary Metal Stents

WallFlex™ Biliary RX Stents



WallFlex Biliary RX Fully Covered Stent System*

| Order Number | GTIN | Diameter (mm) | Length (mm) | Covered Length (mm) (PC Only) | Catheter Diameter (Fr / mm) | Guidewire Diameter (in / mm) | Working Length (cm) | Packaging |
|--------------|----------------|---------------|-------------|-------------------------------|-----------------------------|------------------------------|---------------------|-----------|
| M00570500 | 08714729764885 | 8 | 60 | – | 8.5 / 2.83 | .035 / .89 | 194 | Each |
| M00570510 | 08714729764892 | 8 | 80 | – | 8.5 / 2.83 | .035 / .89 | 194 | Each |
| M00570520 | 08714729764908 | 10 | 40 | – | 8.5 / 2.83 | .035 / .89 | 194 | Each |
| M00570530 | 08714729764915 | 10 | 60 | – | 8.5 / 2.83 | .035 / .89 | 194 | Each |
| M00570540 | 08714729764922 | 10 | 80 | – | 8.5 / 2.83 | .035 / .89 | 194 | Each |

*Compatible with Boston Scientific .035" guidewires, including Dreamwire™ Guidewire (Click here to view page 3).

Above (WallFlex Biliary RX Partially Covered Stent System) with Permalume™ Covering.

†Product with this symbol may be used in Magnetic Resonance environment according to the conditions described in Directions for Use.



WallFlex Biliary RX Partially Covered Stent System*

| Order Number | GTIN | Diameter (mm) | Length (mm) | Covered Length (mm) (PC Only) | Catheter Diameter (Fr / mm) | Guidewire Diameter (in / mm) | Working Length (cm) | Packaging |
|--------------|----------------|---------------|-------------|-------------------------------|-----------------------------|------------------------------|---------------------|-----------|
| M00570700 | 08714729759294 | 8 | 60 | 48 | 8.5 / 2.83 | .035 / .89 | 194 | Each |
| M00570710 | 08714729759300 | 8 | 80 | 68 | 8.5 / 2.83 | .035 / .89 | 194 | Each |
| M00570720 | 08714729759317 | 10 | 40 | 28 | 8.5 / 2.83 | .035 / .89 | 194 | Each |
| M00570730 | 08714729759324 | 10 | 60 | 48 | 8.5 / 2.83 | .035 / .89 | 194 | Each |
| M00570740 | 08714729759331 | 10 | 80 | 68 | 8.5 / 2.83 | .035 / .89 | 194 | Each |

*Compatible with Boston Scientific .035" guidewires, including Dreamwire Guidewire (Click here to view page 3).

Above (WallFlex Biliary RX Partially Covered Stent System) with Permalume Covering.

†Product with this symbol may be used in Magnetic Resonance environment according to the conditions described in Directions for Use.



WallFlex Biliary RX Uncovered Stent System*

| Order Number | GTIN | Diameter (mm) | Length (mm) | Covered Length (mm) (PC Only) | Catheter Diameter (Fr / mm) | Guidewire Diameter (in / mm) | Working Length (cm) | Packaging |
|--------------|----------------|---------------|-------------|-------------------------------|-----------------------------|------------------------------|---------------------|-----------|
| M00570600 | 08714729759249 | 8 | 40 | – | 8.0 / 2.67 | .035 / .89 | 194 | Each |
| M00570610 | 08714729759256 | 8 | 60 | – | 8.0 / 2.67 | .035 / .89 | 194 | Each |
| M00570620 | 08714729759263 | 8 | 80 | – | 8.0 / 2.67 | .035 / .89 | 194 | Each |
| M00570630 | 08714729759270 | 8 | 100 | – | 8.0 / 2.67 | .035 / .89 | 194 | Each |
| M00570890 | 08714729765332 | 10 | 40 | – | 8.0 / 2.67 | .035 / .89 | 194 | Each |
| M00570640 | 08714729756231 | 10 | 60 | – | 8.0 / 2.67 | .035 / .89 | 194 | Each |
| M00570650 | 08714729758150 | 10 | 80 | – | 8.0 / 2.67 | .035 / .89 | 194 | Each |
| M00570660 | 08714729759287 | 10 | 100 | – | 8.0 / 2.67 | .035 / .89 | 194 | Each |

*Compatible with Boston Scientific .035" guidewires, including Dreamwire Guidewire (Click here to view 3).

†Product with this symbol may be used in Magnetic Resonance environment according to the conditions described in Directions for Use.

Biliary Metal Stents

WALLSTENT™ Biliary RX Stents



 Magnetic Resonance Conditional¹

WALLSTENT RX Biliary Endoprosthesis* Stent System



| Order Number | GTIN | Description | Unconstrained Diameter (mm) | Nominal Unconstrained Length (mm) | Delivery System (Fr) | Cover Length (mm) | Working Length (cm) | Packaging |
|--------------|----------------|---|-----------------------------|-----------------------------------|----------------------|-------------------|---------------------|-----------|
| M00569670 | 08714729296874 | WALLSTENT RX Biliary Partially Covered Stent System | 8 | 40 | 8 | 30 | 194 | Each |
| M00569680 | 08714729296881 | WALLSTENT RX Biliary Partially Covered Stent System | 8 | 60 | 8 | 50 | 194 | Each |
| M00569690 | 08714729296898 | WALLSTENT RX Biliary Partially Covered Stent System | 8 | 80 | 8 | 70 | 194 | Each |
| M00569700 | 08714729296904 | WALLSTENT RX Biliary Partially Covered Stent System | 10 | 40 | 8 | 30 | 194 | Each |
| M00569710 | 08714729296911 | WALLSTENT RX Biliary Partially Covered Stent System | 10 | 60 | 8 | 50 | 194 | Each |
| M00569720 | 08714729296928 | WALLSTENT RX Biliary Partially Covered Stent System | 10 | 80 | 8 | 70 | 194 | Each |

*Recommended Guidewire: .035", 260cm, including Dreamwire™ Guidewire  (Click here to view page 3).

Above (Wallstent RX Biliary Endoprosthesis Stent System) with Permalume™ Covering.

¹Product with this symbol may be used in Magnetic Resonance environment according to the conditions described in Directions for Use.



 Magnetic Resonance Conditional¹

WALLSTENT RX Biliary Endoprosthesis* Stent System



| Order Number | GTIN | Description | Unconstrained Diameter (mm) | Nominal Unconstrained Length (mm) | Delivery System (Fr) | Working Length (cm) | Packaging |
|--------------|----------------|---|-----------------------------|-----------------------------------|----------------------|---------------------|-----------|
| M00569610 | 08714729296812 | WALLSTENT RX Biliary Uncovered Stent System | 8 | 40 | 8 | 194 | Each |
| M00569620 | 08714729296829 | WALLSTENT RX Biliary Uncovered Stent System | 8 | 60 | 8 | 194 | Each |
| M00569630 | 08714729296836 | WALLSTENT RX Biliary Uncovered Stent System | 8 | 80 | 8 | 194 | Each |
| M00569800 | 08714729456711 | WALLSTENT RX Biliary Uncovered Stent System | 8 | 100 | 8 | 194 | Each |
| M00569640 | 08714729296843 | WALLSTENT RX Biliary Uncovered Stent System | 10 | 40 | 8 | 194 | Each |
| M00569650 | 08714729296850 | WALLSTENT RX Biliary Uncovered Stent System | 10 | 60 | 8 | 194 | Each |
| M00569660 | 08714729296867 | WALLSTENT RX Biliary Uncovered Stent System | 10 | 80 | 8 | 194 | Each |
| M00569810 | 08714729456728 | WALLSTENT RX Biliary Uncovered Stent System | 10 | 100 | 8 | 194 | Each |

*Recommended Guidewire: .035", 260cm, including Dreamwire Guidewire  (Click here to view page 3).

¹Product with this symbol may be used in Magnetic Resonance environment according to the conditions described in Directions for Use.

Biliary Metal Stents

WALLSTENT™ Stents

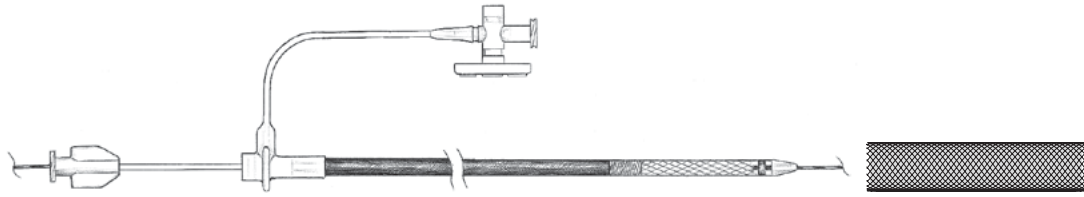

 Magnetic Resonance Conditional*

WALLSTENT Endoscopic Biliary Endoprosthesis Stents*



| Order Number | GTIN | Description | Unconstrained Diameter (mm) | Nominal Unconstrained Length (mm) | Delivery System (Fr) | Cover Length (mm) | Working Length (cm) | Packaging |
|--------------|----------------|---|-----------------------------|-----------------------------------|----------------------|-------------------|---------------------|-----------|
| H965430700 | 08714729229858 | WALLSTENT Biliary Partially Covered Stent | 8 | 40 | 8 | 30 | 194 | Each |
| H965430800 | 08714729317906 | WALLSTENT Biliary Partially Covered Stent | 8 | 60 | 8 | 50 | 194 | Each |
| H965430900 | 08714729229872 | WALLSTENT Biliary Partially Covered Stent | 8 | 80 | 8 | 70 | 194 | Each |
| H965431000 | 08714729317920 | WALLSTENT Biliary Partially Covered Stent | 10 | 40 | 8 | 30 | 194 | Each |
| H965431100 | 08714729317937 | WALLSTENT Biliary Partially Covered Stent | 10 | 60 | 8 | 50 | 194 | Each |
| H965431200 | 08714729229902 | WALLSTENT Biliary Partially Covered Stent | 10 | 80 | 8 | 70 | 194 | Each |

*Recommended Guidewire: .035", 450cm, including Dreamwire™ Guidewire [▶ \(Click here to view page 3\)](#).

Above (Wallstent Biliary Endoprosthesis) with Permalume™ Covering.

*Product with this symbol may be used in Magnetic Resonance environment according to the conditions described in Directions for Use.

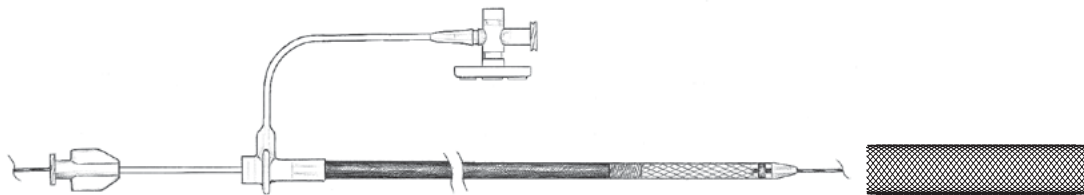

 Magnetic Resonance Conditional*

WALLSTENT Endoscopic Biliary Endoprosthesis Stents*



| Order Number | GTIN | Description | Unconstrained Diameter (mm) | Nominal Unconstrained Length (mm) | Delivery System Diameter (Fr) | Working Length (cm) | Packaging |
|--------------|----------------|-----------------------------------|-----------------------------|-----------------------------------|-------------------------------|---------------------|-----------|
| H965430100 | 08714729204633 | WALLSTENT Biliary Uncovered Stent | 8 | 40 | 7.5 | 194 | Each |
| H965430200 | 08714729204640 | WALLSTENT Biliary Uncovered Stent | 8 | 60 | 7.5 | 194 | Each |
| H965430300 | 08714729204657 | WALLSTENT Biliary Uncovered Stent | 8 | 80 | 7.5 | 194 | Each |
| H965430400 | 08714729204664 | WALLSTENT Biliary Uncovered Stent | 10 | 40 | 7.5 | 194 | Each |
| H965430500 | 08714729204671 | WALLSTENT Biliary Uncovered Stent | 10 | 60 | 7.5 | 194 | Each |
| H965430600 | 08714729204688 | WALLSTENT Biliary Uncovered Stent | 10 | 80 | 7.5 | 194 | Each |

*Recommended Guidewire: .035", 450cm, including Dreamwire Guidewire [▶ \(Click here to view page 3\)](#).

*Product with this symbol may be used in Magnetic Resonance environment according to the conditions described in Directions for Use.

Biliary Plastic Stents

Advanix™ Biliary Stents



Advanix Duodenal Bend Preloaded RX Stent Systems



| Order Number | GTIN | Description | Stent Diameter (Fr) | Length (cm) Barb to Barb | Packaging |
|--------------|----------------|---------------|---------------------|--------------------------|-----------|
| M00534200 | 08714729787297 | Duodenal Bend | 7 | 5 | Each |
| M00534210 | 08714729787303 | Duodenal Bend | 7 | 7 | Each |
| M00534220 | 08714729787310 | Duodenal Bend | 7 | 9 | Each |
| M00534230 | 08714729787327 | Duodenal Bend | 7 | 12 | Each |
| M00534240 | 08714729787334 | Duodenal Bend | 7 | 15 | Each |
| M00534250 | 08714729787341 | Duodenal Bend | 7 | 18 | Each |
| M00534260 | 08714729787358 | Duodenal Bend | 8.5 | 5 | Each |
| M00534270 | 08714729787365 | Duodenal Bend | 8.5 | 7 | Each |
| M00534280 | 08714729787372 | Duodenal Bend | 8.5 | 9 | Each |
| M00534290 | 08714729787389 | Duodenal Bend | 8.5 | 12 | Each |
| M00534300 | 08714729787396 | Duodenal Bend | 8.5 | 15 | Each |
| M00534310 | 08714729787402 | Duodenal Bend | 8.5 | 18 | Each |
| M00534320 | 08714729787419 | Duodenal Bend | 10 | 5 | Each |
| M00534330 | 08714729787426 | Duodenal Bend | 10 | 7 | Each |
| M00534340 | 08714729787433 | Duodenal Bend | 10 | 9 | Each |
| M00534350 | 08714729787440 | Duodenal Bend | 10 | 12 | Each |
| M00534360 | 08714729787457 | Duodenal Bend | 10 | 15 | Each |
| M00534370 | 08714729787464 | Duodenal Bend | 10 | 18 | Each |

Scope Compatibility: 7Fr and 8.5Fr stents require a 3.2mm working channel; 10Fr stents require a 4.2mm working channel.



Advanix Center Bend Preloaded RX Stent Systems



| Order Number | GTIN | Description | Stent Diameter (Fr) | Length (cm) Barb to Barb | Packaging |
|--------------|----------------|-------------|---------------------|--------------------------|-----------|
| M00534560 | 08714729787112 | Center Bend | 7 | 5 | Each |
| M00534570 | 08714729787129 | Center Bend | 7 | 7 | Each |
| M00534580 | 08714729787136 | Center Bend | 7 | 9 | Each |
| M00534590 | 08714729787143 | Center Bend | 7 | 12 | Each |
| M00534600 | 08714729787150 | Center Bend | 7 | 15 | Each |
| M00534610 | 08714729787167 | Center Bend | 7 | 18 | Each |
| M00534620 | 08714729787174 | Center Bend | 8.5 | 5 | Each |
| M00534630 | 08714729787181 | Center Bend | 8.5 | 7 | Each |
| M00534640 | 08714729787198 | Center Bend | 8.5 | 9 | Each |
| M00534650 | 08714729787204 | Center Bend | 8.5 | 12 | Each |
| M00534660 | 08714729787211 | Center Bend | 8.5 | 15 | Each |
| M00534670 | 08714729787228 | Center Bend | 8.5 | 18 | Each |
| M00534680 | 08714729787235 | Center Bend | 10 | 5 | Each |
| M00534690 | 08714729787242 | Center Bend | 10 | 7 | Each |
| M00534700 | 08714729787259 | Center Bend | 10 | 9 | Each |
| M00534710 | 08714729787266 | Center Bend | 10 | 12 | Each |
| M00534720 | 08714729787273 | Center Bend | 10 | 15 | Each |
| M00534730 | 08714729787280 | Center Bend | 10 | 18 | Each |

Scope Compatibility: 7Fr and 8.5Fr stents require a 3.2mm working channel; 10Fr stents require a 4.2mm working channel.



Section Table of Contents

Prev Page ◀ 20 ▶ Next Page

Main Table of Contents



Biliary Plastic Stents

Advanix™ Biliary Stents (Continued)



| Advanix Duodenal Bend - Single Stent | | | | | | |
|--------------------------------------|----------------|---------------|---------------------|--------------------------|-----------|--|
| Order Number | GTIN | Description | Stent Diameter (Fr) | Length (cm) Barb to Barb | Packaging | |
| M00532870 | 08714729786788 | Duodenal Bend | 7 | 5 | Each | |
| M00532880 | 08714729786795 | Duodenal Bend | 7 | 7 | Each | |
| M00532890 | 08714729786801 | Duodenal Bend | 7 | 9 | Each | |
| M00532900 | 08714729786818 | Duodenal Bend | 7 | 12 | Each | |
| M00532910 | 08714729786825 | Duodenal Bend | 7 | 15 | Each | |
| M00532920 | 08714729786832 | Duodenal Bend | 7 | 18 | Each | |
| M00532930 | 08714729786849 | Duodenal Bend | 8.5 | 5 | Each | |
| M00532940 | 08714729786856 | Duodenal Bend | 8.5 | 7 | Each | |
| M00532950 | 08714729786863 | Duodenal Bend | 8.5 | 9 | Each | |
| M00532960 | 08714729786870 | Duodenal Bend | 8.5 | 12 | Each | |
| M00532970 | 08714729786887 | Duodenal Bend | 8.5 | 15 | Each | |
| M00532980 | 08714729786894 | Duodenal Bend | 8.5 | 18 | Each | |
| M00532990 | 08714729786900 | Duodenal Bend | 10 | 5 | Each | |
| M00533000 | 08714729786917 | Duodenal Bend | 10 | 7 | Each | |
| M00533010 | 08714729786924 | Duodenal Bend | 10 | 9 | Each | |
| M00533020 | 08714729786931 | Duodenal Bend | 10 | 12 | Each | |
| M00533030 | 08714729786948 | Duodenal Bend | 10 | 15 | Each | |
| M00533040 | 08714729786955 | Duodenal Bend | 10 | 18 | Each | |

Scope Compatibility: 7Fr and 8.5Fr stents require a 3.2mm working channel; 10Fr stents require a 4.2mm working channel.



| Advanix Center Bend - Single Stent | | | | | | |
|------------------------------------|----------------|-------------|---------------------|--------------------------|-----------|--|
| Order Number | GTIN | Description | Stent Diameter (Fr) | Length (cm) Barb to Barb | Packaging | |
| M00533230 | 08714729786603 | Center Bend | 7 | 5 | Each | |
| M00533240 | 08714729786610 | Center Bend | 7 | 7 | Each | |
| M00533250 | 08714729786627 | Center Bend | 7 | 9 | Each | |
| M00533260 | 08714729786634 | Center Bend | 7 | 12 | Each | |
| M00533270 | 08714729786641 | Center Bend | 7 | 15 | Each | |
| M00533280 | 08714729786658 | Center Bend | 7 | 18 | Each | |
| M00533290 | 08714729786665 | Center Bend | 8.5 | 5 | Each | |
| M00533300 | 08714729786672 | Center Bend | 8.5 | 7 | Each | |
| M00533310 | 08714729786689 | Center Bend | 8.5 | 9 | Each | |
| M00533320 | 08714729786696 | Center Bend | 8.5 | 12 | Each | |
| M00533330 | 08714729786702 | Center Bend | 8.5 | 15 | Each | |
| M00533340 | 08714729786719 | Center Bend | 8.5 | 18 | Each | |
| M00533350 | 08714729786726 | Center Bend | 10 | 5 | Each | |
| M00533360 | 08714729786733 | Center Bend | 10 | 7 | Each | |
| M00533370 | 08714729786740 | Center Bend | 10 | 9 | Each | |
| M00533380 | 08714729786757 | Center Bend | 10 | 12 | Each | |
| M00533390 | 08714729786764 | Center Bend | 10 | 15 | Each | |
| M00533400 | 08714729786771 | Center Bend | 10 | 18 | Each | |

Scope Compatibility: 7Fr and 8.5Fr stents require a 3.2mm working channel; 10Fr stents require a 4.2mm working channel.

Biliary Plastic Stents

Advanix™ Biliary Stents (Continued)



Advanix Double Pigtail - Single Stent



| Order Number | GTIN | Description | Stent Diameter (Fr) | Length (cm) Between Pigtails | Packaging |
|--------------|----------------|----------------|---------------------|------------------------------|-----------|
| M00532160 | 08714729786962 | Double Pigtail | 7 | 3 | Each |
| M00532180 | 08714729786979 | Double Pigtail | 7 | 5 | Each |
| M00532190 | 08714729786986 | Double Pigtail | 7 | 7 | Each |
| M00532210 | 08714729786993 | Double Pigtail | 7 | 10 | Each |
| M00532220 | 08714729787006 | Double Pigtail | 7 | 12 | Each |
| M00532230 | 08714729787013 | Double Pigtail | 7 | 15 | Each |
| M00532240 | 08714729787020 | Double Pigtail | 10 | 3 | Each |
| M00532260 | 08714729787037 | Double Pigtail | 10 | 5 | Each |
| M00532270 | 08714729787044 | Double Pigtail | 10 | 7 | Each |
| M00532290 | 08714729787051 | Double Pigtail | 10 | 10 | Each |
| M00532300 | 08714729787068 | Double Pigtail | 10 | 12 | Each |
| M00532310 | 08714729787075 | Double Pigtail | 10 | 15 | Each |

Scope Compatibility: 7Fr and 8.5Fr stents require a 3.2mm working channel; 10Fr stents require a 4.2mm working channel.

Naviflex™ RX Delivery System



Naviflex RX Delivery System*



| Order Number | GTIN | Description | Catheter Diameter (Fr) | Length (cm) | Packaging |
|--------------|----------------|--------------------|------------------------|-------------|-----------|
| M00533560 | 08714729787082 | RX Delivery System | 7 | 202.5 | Each |
| M00533570 | 08714729787099 | RX Delivery System | 8.5 | 202.5 | Each |
| M00533580 | 08714729787105 | RX Delivery System | 10 | 202.5 | Each |

*Compatible with Advanix Biliary Stents.



Biliary Plastic Stents

Duodenal Bend Stents

RX Duodenal Bend Biliary Stent with RX Delivery System



| Order Number | GTIN | Description | O.D. (Fr) | Length (cm) Barb to Barb | Recommended Guidewire (in) | Packaging |
|--------------|----------------|---|-----------|--------------------------|----------------------------|-----------|
| M00545550 | 08714729337850 | Duodenal Bend Biliary Stent with RX Delivery System | 7 | 5 | .035 | Each |
| M00545560 | 08714729337867 | Duodenal Bend Biliary Stent with RX Delivery System | 7 | 7 | .035 | Each |
| M00545570 | 08714729337874 | Duodenal Bend Biliary Stent with RX Delivery System | 7 | 10 | .035 | Each |
| M00545580 | 08714729337881 | Duodenal Bend Biliary Stent with RX Delivery System | 7 | 12 | .035 | Each |
| M00545590 | 08714729337898 | Duodenal Bend Biliary Stent with RX Delivery System | 7 | 15 | .035 | Each |
| M00545650 | 08714729252221 | Duodenal Bend Biliary Stent with RX Delivery System | 8.5 | 5 | .035 | Each |
| M00545660 | 08714729301837 | Duodenal Bend Biliary Stent with RX Delivery System | 8.5 | 7 | .035 | Each |
| M00545670 | 08714729301844 | Duodenal Bend Biliary Stent with RX Delivery System | 8.5 | 10 | .035 | Each |
| M00545680 | 08714729301851 | Duodenal Bend Biliary Stent with RX Delivery System | 8.5 | 12 | .035 | Each |
| M00545690 | 08714729301868 | Duodenal Bend Biliary Stent with RX Delivery System | 8.5 | 15 | .035 | Each |
| M00545600 | 08714729337904 | Duodenal Bend Biliary Stent with RX Delivery System | 10 | 5 | .035 | Each |
| M00545610 | 08714729337911 | Duodenal Bend Biliary Stent with RX Delivery System | 10 | 7 | .035 | Each |
| M00545620 | 08714729337928 | Duodenal Bend Biliary Stent with RX Delivery System | 10 | 10 | .035 | Each |
| M00545630 | 08714729301813 | Duodenal Bend Biliary Stent with RX Delivery System | 10 | 12 | .035 | Each |
| M00545640 | 08714729301820 | Duodenal Bend Biliary Stent with RX Delivery System | 10 | 15 | .035 | Each |
| M00545700 | 08714729301875 | Duodenal Bend Biliary Stent with RX Delivery System | 11.5 | 5 | .035 | Each |
| M00545710 | 08714729301882 | Duodenal Bend Biliary Stent with RX Delivery System | 11.5 | 7 | .035 | Each |
| M00545720 | 08714729301899 | Duodenal Bend Biliary Stent with RX Delivery System | 11.5 | 10 | .035 | Each |
| M00545730 | 08714729337942 | Duodenal Bend Biliary Stent with RX Delivery System | 11.5 | 12 | .035 | Each |
| M00545740 | 08714729337959 | Duodenal Bend Biliary Stent with RX Delivery System | 11.5 | 15 | .035 | Each |



Flexima™ Duodenal Bend Biliary Stent with Delivery System



| Order Number | GTIN | O.D. (Fr) | Length (cm) Barb to Barb | Recommended Guidewire (in) | Packaging |
|--------------|----------------|-----------|--------------------------|----------------------------|-----------|
| M00539200 | 08714729337362 | 7 | 5 | .035 | Each |
| M00539210 | 08714729162520 | 7 | 7 | .035 | Each |
| M00539220 | 08714729162537 | 7 | 10 | .035 | Each |
| M00539230 | 08714729162544 | 7 | 12 | .035 | Each |
| M00539240 | 08714729162551 | 7 | 15 | .035 | Each |
| M00539250 | 08714729162568 | 8.5 | 5 | .035 | Each |
| M00539260 | 08714729162575 | 8.5 | 7 | .035 | Each |
| M00539270 | 08714729162582 | 8.5 | 10 | .035 | Each |
| M00539280 | 08714729162599 | 8.5 | 12 | .035 | Each |
| M00539290 | 08714729162605 | 8.5 | 15 | .035 | Each |
| M00539300 | 08714729162612 | 10 | 5 | .035 | Each |
| M00539310 | 08714729162629 | 10 | 7 | .035 | Each |
| M00539320 | 08714729162636 | 10 | 10 | .035 | Each |
| M00539330 | 08714729162643 | 10 | 12 | .035 | Each |
| M00539340 | 08714729162650 | 10 | 15 | .035 | Each |
| M00539350 | 08714729162667 | 11.5 | 5 | .035 | Each |
| M00539360 | 08714729162674 | 11.5 | 7 | .035 | Each |
| M00539370 | 08714729162681 | 11.5 | 10 | .035 | Each |
| M00539380 | 08714729162698 | 11.5 | 12 | .035 | Each |
| M00539390 | 08714729162704 | 11.5 | 15 | .035 | Each |

Biliary Plastic Stents

Duodenal Bend Stents *(Continued)*



Percuflex™ Duodenal Bend Biliary Stent ⓧ

| Order Number | GTIN | O.D. (Fr) | Length (cm) Barb to Barb | Recommended Guidewire (in) | Packaging |
|--------------|----------------|-----------|--------------------------|----------------------------|-----------|
| M00533610 | 08714729181217 | 7 | 5 | .035 | Each |
| M00533620 | 08714729181224 | 7 | 7 | .035 | Each |
| M00533630 | 08714729181231 | 7 | 10 | .035 | Each |
| M00533640 | 08714729181248 | 7 | 12 | .035 | Each |
| M00533650 | 08714729181255 | 7 | 15 | .035 | Each |
| M00533660 | 08714729181262 | 10 | 5 | .035 | Each |
| M00533670 | 08714729181279 | 10 | 7 | .035 | Each |
| M00533680 | 08714729181286 | 10 | 10 | .035 | Each |
| M00533690 | 08714729181293 | 10 | 12 | .035 | Each |
| M00533700 | 08714729181309 | 10 | 15 | .035 | Each |

Percuflex Duodenal Bend Biliary Stent with Introducer Kit ⓧ

| Order Number | GTIN | Description | O.D. (Fr) | Length (cm) Barb to Barb | Packaging |
|--------------|----------------|--|-----------|--------------------------|-----------|
| M00533760 | 08714729181088 | Percuflex Stent w/ push catheter | 7 | 5 | Each |
| M00533770 | 08714729181095 | Percuflex Stent w/ push catheter | 7 | 7 | Each |
| M00533780 | 08714729181101 | Percuflex Stent w/ push catheter | 7 | 10 | Each |
| M00533790 | 08714729181118 | Percuflex Stent w/ push catheter | 7 | 12 | Each |
| M00533800 | 08714729181125 | Percuflex Stent w/ push catheter | 7 | 15 | Each |
| M00533810 | 08714729181132 | Percuflex Stent w/ push and guide catheter | 10 | 5 | Each |
| M00533820 | 08714729181149 | Percuflex Stent w/ push and guide catheter | 10 | 7 | Each |
| M00533830 | 08714729181156 | Percuflex Stent w/ push and guide catheter | 10 | 10 | Each |
| M00533840 | 08714729193449 | Percuflex Stent w/ push and guide catheter | 10 | 12 | Each |
| M00533850 | 08714729181163 | Percuflex Stent w/ push and guide catheter | 10 | 15 | Each |

Biliary Introducer* ⓧ

| Order Number | GTIN | Description | O.D. (Fr) | Recommended Guidewire (in) | Packaging |
|--------------|----------------|-------------------------|-----------|----------------------------|-----------|
| M00533910 | 08714729181439 | Push catheter | 7 | .035 | Each |
| M00533920 | 08714729193463 | Push and guide catheter | 10 | .035 | Each |

*Stents sold separately.

Biliary Plastic Stents

Pigtail Stents



C-Flex™ Double Pigtail Biliary Stent



| Order Number | GTIN | O.D. (Fr) | Length (cm) Between Pigtails | Color Code | Packaging |
|--------------|----------------|-----------|------------------------------|------------|-----------|
| M00532010 | 08714729019077 | 7 | 5 | Blue | Each |
| M00532020 | 08714729019084 | 7 | 10 | Blue | Each |
| M00532030 | 08714729019091 | 7 | 15 | Blue | Each |
| M00532040 | 08714729019107 | 10 | 5 | Grey | Each |
| M00532050 | 08714729019114 | 10 | 10 | Grey | Each |

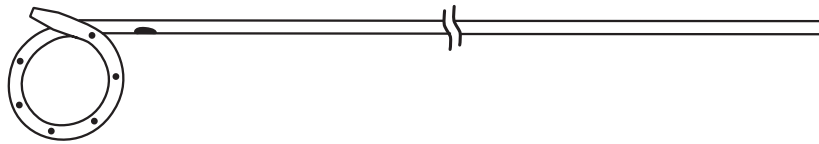

Flexima™ Single Pigtail Nasobiliary Catheter*



| Order Number | GTIN | O.D. (Fr) | Working Length (cm) | Packaging |
|--------------|----------------|-----------|---------------------|-----------|
| M00540110 | 08714729337379 | 5 | 250 | Each |
| M00540120 | 08714729337386 | 6 | 250 | Each |
| M00540130 | 08714729337393 | 7.5 | 250 | Each |
| M00540140 | 08714729337409 | 8.5 | 250 | Each |

*Recommended Guidewire .035" Dreamwire™ Guidewire, Order #5614, [▶ \(Click here to view page 3\)](#).



Section Table of Contents

Prev Page ◀ 25 ▶ Next Page

Main Table of Contents



Pancreatic Plastic Stents

Advanix™ Pancreatic Stents



 Magnetic Resonance Conditional¹

Advanix Pancreatic Stent Kit - Straight, No Leading Barb



| Order Number | GTIN | Description | Diameter (Fr) | Length (cm) | Packaging |
|--------------|----------------|----------------------------------|---------------|-------------|-----------|
| M00537460 | 08714729856245 | Straight Stent – No Leading Barb | 4 | 3 | Each |
| M00537470 | 08714729856252 | Straight Stent – No Leading Barb | 4 | 4 | Each |
| M00537480 | 08714729856269 | Straight Stent – No Leading Barb | 4 | 5 | Each |
| M00537490 | 08714729862956 | Straight Stent – No Leading Barb | 4 | 7 | Each |
| M00537500 | 08714729856276 | Straight Stent – No Leading Barb | 5 | 3 | Each |
| M00537510 | 08714729856283 | Straight Stent – No Leading Barb | 5 | 4 | Each |
| M00537520 | 08714729856290 | Straight Stent – No Leading Barb | 5 | 5 | Each |
| M00537530 | 08714729856306 | Straight Stent – No Leading Barb | 5 | 7 | Each |
| M00537540 | 08714729856313 | Straight Stent – No Leading Barb | 5 | 3 | Each |
| M00537550 | 08714729856320 | Straight Stent – No Leading Barb | 5 | 4 | Each |
| M00537560 | 08714729856337 | Straight Stent – No Leading Barb | 5 | 5 | Each |



 Magnetic Resonance Conditional¹

Advanix Pancreatic Stent Kit - Pigtail, Leading Barb and No Leading Barb



| Order Number | GTIN | Description | Diameter (Fr) | Length (cm) | Packaging |
|--------------|----------------|--|---------------|-------------|-----------|
| M00537350 | 08714729856344 | Single Pigtail Stent – No Leading Barb | 4 | 3 | Each |
| M00537360 | 08714729856351 | Single Pigtail Stent – No Leading Barb | 4 | 4 | Each |
| M00537370 | 08714729856368 | Single Pigtail Stent – No Leading Barb | 4 | 5 | Each |
| M00537380 | 08714729856375 | Single Pigtail Stent – No Leading Barb | 4 | 7 | Each |
| M00537390 | 08714729856382 | Single Pigtail Stent – No Leading Barb | 5 | 3 | Each |
| M00537400 | 08714729856399 | Single Pigtail Stent – No Leading Barb | 5 | 4 | Each |
| M00537410 | 08714729856405 | Single Pigtail Stent – No Leading Barb | 5 | 5 | Each |
| M00537420 | 08714729856412 | Single Pigtail Stent – No Leading Barb | 5 | 7 | Each |
| M00537430 | 08714729856429 | Single Pigtail Stent – Leading Barb | 5 | 3 | Each |
| M00537440 | 08714729856436 | Single Pigtail Stent – Leading Barb | 5 | 4 | Each |
| M00537450 | 08714729856443 | Single Pigtail Stent – Leading Barb | 5 | 5 | Each |

Pancreatic Plastic Stents

Advanix™ Pancreatic Stents (Continued)



 Magnetic Resonance Conditional¹

Advanix Pancreatic Stent - Straight, No Leading Barb

| Order Number | GTIN | Description | Diameter (Fr) | Length (cm) | Packaging |
|--------------|----------------|----------------------------|---------------|-------------|-----------|
| M00536000 | 08714729857686 | Straight – No Leading Barb | 3 | 2 | Each |
| M00536010 | 08714729857693 | Straight – No Leading Barb | 3 | 3 | Each |
| M00536020 | 08714729857709 | Straight – No Leading Barb | 3 | 4 | Each |
| M00536030 | 08714729857716 | Straight – No Leading Barb | 3 | 5 | Each |
| M00536040 | 08714729857723 | Straight – No Leading Barb | 3 | 6 | Each |
| M00536050 | 08714729857730 | Straight – No Leading Barb | 3 | 7 | Each |
| M00536060 | 08714729857747 | Straight – No Leading Barb | 3 | 8 | Each |
| M00536070 | 08714729857754 | Straight – No Leading Barb | 3 | 9 | Each |
| M00536080 | 08714729857761 | Straight – No Leading Barb | 3 | 10 | Each |
| M00536090 | 08714729857778 | Straight – No Leading Barb | 3 | 11 | Each |
| M00536100 | 08714729857785 | Straight – No Leading Barb | 3 | 12 | Each |
| M00536110 | 08714729857792 | Straight – No Leading Barb | 3 | 13 | Each |
| M00536120 | 08714729857068 | Straight – No Leading Barb | 4 | 2 | Each |
| M00536130 | 08714729857075 | Straight – No Leading Barb | 4 | 3 | Each |
| M00536140 | 08714729857082 | Straight – No Leading Barb | 4 | 4 | Each |
| M00536150 | 08714729857099 | Straight – No Leading Barb | 4 | 5 | Each |
| M00536160 | 08714729857105 | Straight – No Leading Barb | 4 | 6 | Each |
| M00536170 | 08714729857112 | Straight – No Leading Barb | 4 | 7 | Each |
| M00536180 | 08714729857129 | Straight – No Leading Barb | 4 | 8 | Each |
| M00536190 | 08714729857136 | Straight – No Leading Barb | 4 | 9 | Each |
| M00536200 | 08714729857143 | Straight – No Leading Barb | 4 | 10 | Each |
| M00536210 | 08714729857150 | Straight – No Leading Barb | 4 | 11 | Each |
| M00536220 | 08714729857167 | Straight – No Leading Barb | 4 | 12 | Each |
| M00536230 | 08714729857174 | Straight – No Leading Barb | 4 | 13 | Each |
| M00536240 | 08714729857181 | Straight – No Leading Barb | 5 | 2 | Each |
| M00536250 | 08714729857198 | Straight – No Leading Barb | 5 | 3 | Each |
| M00536260 | 08714729857204 | Straight – No Leading Barb | 5 | 4 | Each |
| M00536270 | 08714729857211 | Straight – No Leading Barb | 5 | 5 | Each |
| M00536280 | 08714729857228 | Straight – No Leading Barb | 5 | 6 | Each |
| M00536290 | 08714729857235 | Straight – No Leading Barb | 5 | 7 | Each |
| M00536300 | 08714729857242 | Straight – No Leading Barb | 5 | 8 | Each |
| M00536310 | 08714729857259 | Straight – No Leading Barb | 5 | 9 | Each |
| M00536320 | 08714729857266 | Straight – No Leading Barb | 5 | 10 | Each |
| M00536330 | 08714729857273 | Straight – No Leading Barb | 5 | 11 | Each |
| M00536340 | 08714729857280 | Straight – No Leading Barb | 5 | 12 | Each |
| M00536350 | 08714729857297 | Straight – No Leading Barb | 5 | 13 | Each |

Pancreatic Plastic Stents

Advanix™ Pancreatic Stents (Continued)



 Magnetic Resonance
Conditional*

Advanix Pancreatic Stent - Straight, Leading Barb

| Order Number | GTIN | Description | Diameter (Fr) | Length (cm) | Packaging |
|--------------|----------------|-------------------------|---------------|-------------|-----------|
| M00536360 | 08714729857303 | Straight – Leading Barb | 5 | 2 | Each |
| M00536370 | 08714729857310 | Straight – Leading Barb | 5 | 3 | Each |
| M00536380 | 08714729857327 | Straight – Leading Barb | 5 | 4 | Each |
| M00536390 | 08714729857334 | Straight – Leading Barb | 5 | 5 | Each |
| M00536400 | 08714729857341 | Straight – Leading Barb | 5 | 6 | Each |
| M00536410 | 08714729857358 | Straight – Leading Barb | 5 | 7 | Each |
| M00536420 | 08714729857365 | Straight – Leading Barb | 5 | 8 | Each |
| M00536430 | 08714729857372 | Straight – Leading Barb | 5 | 9 | Each |
| M00536440 | 08714729857389 | Straight – Leading Barb | 5 | 10 | Each |
| M00536450 | 08714729857396 | Straight – Leading Barb | 5 | 11 | Each |
| M00536460 | 08714729857402 | Straight – Leading Barb | 5 | 12 | Each |
| M00536470 | 08714729857419 | Straight – Leading Barb | 5 | 13 | Each |
| M00536480 | 08714729857426 | Straight – Leading Barb | 7 | 3 | Each |
| M00536490 | 08714729857433 | Straight – Leading Barb | 7 | 4 | Each |
| M00536500 | 08714729857440 | Straight – Leading Barb | 7 | 5 | Each |
| M00536510 | 08714729857457 | Straight – Leading Barb | 7 | 6 | Each |
| M00536520 | 08714729857464 | Straight – Leading Barb | 7 | 7 | Each |
| M00536530 | 08714729857471 | Straight – Leading Barb | 7 | 8 | Each |
| M00536540 | 08714729857488 | Straight – Leading Barb | 7 | 9 | Each |
| M00536550 | 08714729857495 | Straight – Leading Barb | 7 | 10 | Each |
| M00536560 | 08714729857501 | Straight – Leading Barb | 7 | 11 | Each |
| M00536570 | 08714729857518 | Straight – Leading Barb | 7 | 12 | Each |
| M00536580 | 08714729857525 | Straight – Leading Barb | 7 | 13 | Each |
| M00536590 | 08714729857532 | Straight – Leading Barb | 7 | 15 | Each |
| M00536600 | 08714729857549 | Straight – Leading Barb | 7 | 18 | Each |
| M00536610 | 08714729857556 | Straight – Leading Barb | 10 | 3 | Each |
| M00536620 | 08714729857563 | Straight – Leading Barb | 10 | 4 | Each |
| M00536630 | 08714729857570 | Straight – Leading Barb | 10 | 5 | Each |
| M00536640 | 08714729857587 | Straight – Leading Barb | 10 | 6 | Each |
| M00536650 | 08714729857594 | Straight – Leading Barb | 10 | 7 | Each |
| M00536660 | 08714729857600 | Straight – Leading Barb | 10 | 8 | Each |
| M00536670 | 08714729857617 | Straight – Leading Barb | 10 | 9 | Each |
| M00536680 | 08714729857624 | Straight – Leading Barb | 10 | 10 | Each |
| M00536690 | 08714729857631 | Straight – Leading Barb | 10 | 11 | Each |
| M00536700 | 08714729857648 | Straight – Leading Barb | 10 | 12 | Each |
| M00536710 | 08714729857655 | Straight – Leading Barb | 10 | 13 | Each |
| M00536720 | 08714729857662 | Straight – Leading Barb | 10 | 15 | Each |
| M00536730 | 08714729857679 | Straight – Leading Barb | 10 | 18 | Each |



Section Table of Contents

Prev Page ◀ 28 ▶ Next Page

Main Table of Contents



Pancreatic Plastic Stents

Advanix™ Pancreatic Stents (Continued)



 Magnetic Resonance Conditional¹

Advanix Pancreatic Stent - Pigtail, No Leading Barb

| Order Number | GTIN | Description | Diameter (Fr) | Length (cm) | Packaging |
|--------------|----------------|----------------------------------|---------------|-------------|-----------|
| M00536740 | 08714729856948 | Single Pigtail – No Leading Barb | 3 | 2 | Each |
| M00536750 | 08714729856955 | Single Pigtail – No Leading Barb | 3 | 3 | Each |
| M00536760 | 08714729856962 | Single Pigtail – No Leading Barb | 3 | 4 | Each |
| M00536770 | 08714729856979 | Single Pigtail – No Leading Barb | 3 | 5 | Each |
| M00536780 | 08714729856986 | Single Pigtail – No Leading Barb | 3 | 6 | Each |
| M00536790 | 08714729856993 | Single Pigtail – No Leading Barb | 3 | 7 | Each |
| M00536800 | 08714729857006 | Single Pigtail – No Leading Barb | 3 | 8 | Each |
| M00536810 | 08714729857013 | Single Pigtail – No Leading Barb | 3 | 9 | Each |
| M00536820 | 08714729857020 | Single Pigtail – No Leading Barb | 3 | 10 | Each |
| M00536830 | 08714729857037 | Single Pigtail – No Leading Barb | 3 | 11 | Each |
| M00536840 | 08714729857044 | Single Pigtail – No Leading Barb | 3 | 12 | Each |
| M00536850 | 08714729857051 | Single Pigtail – No Leading Barb | 3 | 13 | Each |
| M00536860 | 08714729856450 | Single Pigtail – No Leading Barb | 4 | 2 | Each |
| M00536870 | 08714729856467 | Single Pigtail – No Leading Barb | 4 | 3 | Each |
| M00536880 | 08714729856474 | Single Pigtail – No Leading Barb | 4 | 4 | Each |
| M00536890 | 08714729856481 | Single Pigtail – No Leading Barb | 4 | 5 | Each |
| M00536900 | 08714729856498 | Single Pigtail – No Leading Barb | 4 | 6 | Each |
| M00536910 | 08714729856504 | Single Pigtail – No Leading Barb | 4 | 7 | Each |
| M00536920 | 08714729856511 | Single Pigtail – No Leading Barb | 4 | 8 | Each |
| M00536930 | 08714729856528 | Single Pigtail – No Leading Barb | 4 | 9 | Each |
| M00536940 | 08714729856535 | Single Pigtail – No Leading Barb | 4 | 10 | Each |
| M00536950 | 08714729856542 | Single Pigtail – No Leading Barb | 4 | 11 | Each |
| M00536960 | 08714729856559 | Single Pigtail – No Leading Barb | 4 | 12 | Each |
| M00536970 | 08714729856566 | Single Pigtail – No Leading Barb | 4 | 13 | Each |
| M00536980 | 08714729856696 | Single Pigtail – No Leading Barb | 5 | 2 | Each |
| M00536990 | 08714729856702 | Single Pigtail – No Leading Barb | 5 | 3 | Each |
| M00537000 | 08714729856719 | Single Pigtail – No Leading Barb | 5 | 4 | Each |
| M00537010 | 08714729856726 | Single Pigtail – No Leading Barb | 5 | 5 | Each |
| M00537020 | 08714729856733 | Single Pigtail – No Leading Barb | 5 | 6 | Each |
| M00537030 | 08714729856740 | Single Pigtail – No Leading Barb | 5 | 7 | Each |
| M00537040 | 08714729856757 | Single Pigtail – No Leading Barb | 5 | 8 | Each |
| M00537050 | 08714729856764 | Single Pigtail – No Leading Barb | 5 | 9 | Each |
| M00537060 | 08714729856771 | Single Pigtail – No Leading Barb | 5 | 10 | Each |
| M00537070 | 08714729856788 | Single Pigtail – No Leading Barb | 5 | 11 | Each |
| M00537080 | 08714729856795 | Single Pigtail – No Leading Barb | 5 | 12 | Each |
| M00537090 | 08714729856801 | Single Pigtail – No Leading Barb | 5 | 13 | Each |

Pancreatic Plastic Stents

Advanix™ Pancreatic Stents (Continued)



 Magnetic Resonance
Conditional*



Advanix Pancreatic Stent - Pigtail, Leading Barb

| Order Number | GTIN | Description | Diameter (Fr) | Length (cm) | Packaging |
|--------------|----------------|-------------------------------|---------------|-------------|-----------|
| M00537100 | 08714729856573 | Single Pigtail – Leading Barb | 5 | 2 | Each |
| M00537110 | 08714729856580 | Single Pigtail – Leading Barb | 5 | 3 | Each |
| M00537120 | 08714729856597 | Single Pigtail – Leading Barb | 5 | 4 | Each |
| M00537130 | 08714729856603 | Single Pigtail – Leading Barb | 5 | 5 | Each |
| M00537140 | 08714729856610 | Single Pigtail – Leading Barb | 5 | 6 | Each |
| M00537150 | 08714729856627 | Single Pigtail – Leading Barb | 5 | 7 | Each |
| M00537160 | 08714729856634 | Single Pigtail – Leading Barb | 5 | 8 | Each |
| M00537170 | 08714729856641 | Single Pigtail – Leading Barb | 5 | 9 | Each |
| M00537180 | 08714729856658 | Single Pigtail – Leading Barb | 5 | 10 | Each |
| M00537190 | 08714729856665 | Single Pigtail – Leading Barb | 5 | 11 | Each |
| M00537200 | 08714729856672 | Single Pigtail – Leading Barb | 5 | 12 | Each |
| M00537210 | 08714729856689 | Single Pigtail – Leading Barb | 5 | 13 | Each |
| M00537220 | 08714729856818 | Single Pigtail – Leading Barb | 7 | 3 | Each |
| M00537230 | 08714729856825 | Single Pigtail – Leading Barb | 7 | 4 | Each |
| M00537240 | 08714729856832 | Single Pigtail – Leading Barb | 7 | 5 | Each |
| M00537250 | 08714729856849 | Single Pigtail – Leading Barb | 7 | 6 | Each |
| M00537260 | 08714729856856 | Single Pigtail – Leading Barb | 7 | 7 | Each |
| M00537270 | 08714729856863 | Single Pigtail – Leading Barb | 7 | 8 | Each |
| M00537280 | 08714729856870 | Single Pigtail – Leading Barb | 7 | 9 | Each |
| M00537290 | 08714729856887 | Single Pigtail – Leading Barb | 7 | 10 | Each |
| M00537300 | 08714729856894 | Single Pigtail – Leading Barb | 7 | 11 | Each |
| M00537310 | 08714729856900 | Single Pigtail – Leading Barb | 7 | 12 | Each |
| M00537320 | 08714729856917 | Single Pigtail – Leading Barb | 7 | 13 | Each |
| M00537330 | 08714729856924 | Single Pigtail – Leading Barb | 7 | 15 | Each |
| M00537340 | 08714729856931 | Single Pigtail – Leading Barb | 7 | 18 | Each |



Section Table of Contents

Prev Page ◀ 30 ▶ Next Page

Main Table of Contents



Pancreatic Plastic Stents

NaviFlex™ RX Pancreatic Delivery System & NaviFlex Pushers

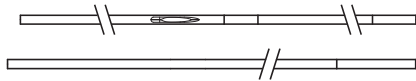

 Magnetic Resonance Conditional*

NaviFlex RX Pancreatic Delivery System & NaviFlex Pushers



| Order Number | GTIN | Description | Diameter (Fr) | Length | Packaging |
|--------------|----------------|--|---------------|--------|-----------|
| M00535060 | 08714729856221 | NaviFlex RX Pancreatic Stent Delivery System | 7 | N/A | Each |
| M00535080 | 08714729856238 | NaviFlex RX Pancreatic Stent Delivery System | 10 | N/A | Each |
| M00535000 | 08714729856207 | Pancreatic Stent RX Pusher | 3 | N/A | Each |
| M00535010 | 08714729856214 | Pancreatic Stent RX Pusher | 4 / 5 | N/A | Each |
| M00535020 | 08714729856184 | Pancreatic Stent Pusher | 3 | N/A | Each |
| M00535030 | 08714729856191 | Pancreatic Stent Pusher | 4 / 5 | N/A | Each |



Section Table of Contents

Prev Page  31  Next Page

Main Table of Contents 

For pricing information contact your Boston Scientific Sales Representative or Customer Service at 1.888.272.1001

Biliary Stone Management

RX Stone Management



Extractor™ Pro RX Retrieval Balloons – Distal Injection



| Order Number | GTIN | Description | Balloon Inflated O.D. (mm) | Working Length (cm) | Catheter O.D. (Fr) | Recommended Guidewire (in) | Packaging |
|--------------|----------------|------------------------------------|----------------------------|---------------------|--------------------|----------------------------|-----------|
| M00547000 | 08714729790266 | Extractor Pro RX Retrieval Balloon | 9.0 – 12.0 | 200 | 7 - 6 | .035 | Each |
| M00547010 | 08714729790297 | Extractor Pro RX Retrieval Balloon | 12.0 – 15.0 | 200 | 7 - 6 | .035 | Each |
| M00547020 | 08714729790310 | Extractor Pro RX Retrieval Balloon | 15.0 – 18.0 | 200 | 7 - 6 | .035 | Each |



Extractor Pro RX Retrieval Balloons – Proximal Injection



| Order Number | GTIN | Description | Balloon Inflated O.D. (mm) | Working Length (cm) | Catheter O.D. (Fr) | Recommended Guidewire (in) | Packaging |
|--------------|----------------|------------------------------------|----------------------------|---------------------|--------------------|----------------------------|-----------|
| M00547030 | 08714729790280 | Extractor Pro RX Retrieval Balloon | 9.0 – 12.0 | 200 | 7 - 6 | .035 | Each |
| M00547040 | 08714729790273 | Extractor Pro RX Retrieval Balloon | 12.0 – 15.0 | 200 | 7 - 6 | .035 | Each |
| M00547050 | 08714729790303 | Extractor Pro RX Retrieval Balloon | 15.0 – 18.0 | 200 | 7 - 6 | .035 | Each |

Stone Management

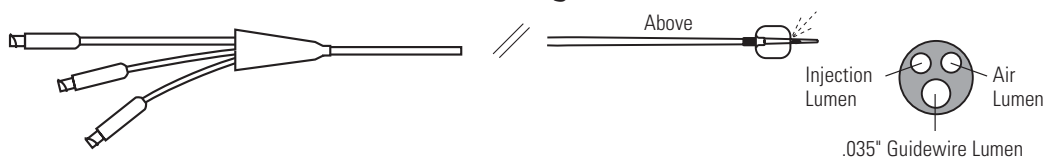

Extractor Pro XL Retrieval Balloons – Distal Injection



| Order Number | GTIN | Description | Balloon Inflated O.D. (mm) | Working Length (cm) | Catheter O.D. (Fr) | Recommended Guidewire (in) | Packaging |
|--------------|----------------|------------------------------------|----------------------------|---------------------|--------------------|----------------------------|-----------|
| M00547100 | 08714729790389 | Extractor Pro XL Retrieval Balloon | 9.0 – 12.0 | 200 | 7 - 6 | .035 | Each |
| M00547110 | 08714729790402 | Extractor Pro XL Retrieval Balloon | 12.0 – 15.0 | 200 | 7 - 6 | .035 | Each |
| M00547120 | 08714729790648 | Extractor Pro XL Retrieval Balloon | 15.0 – 18.0 | 200 | 7 - 6 | .035 | Each |

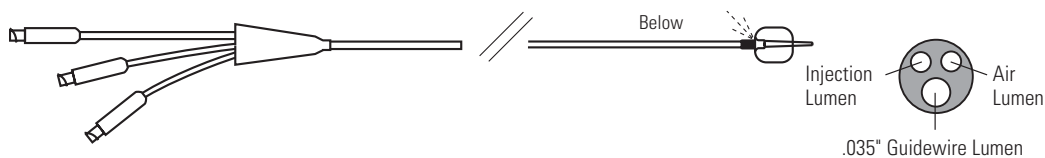

Extractor Pro XL Retrieval Balloons – Proximal Injection



| Order Number | GTIN | Description | Balloon Inflated O.D. (mm) | Working Length (cm) | Catheter O.D. (Fr) | Recommended Guidewire (in) | Packaging |
|--------------|----------------|------------------------------------|----------------------------|---------------------|--------------------|----------------------------|-----------|
| M00547130 | 08714729790396 | Extractor Pro XL Retrieval Balloon | 9.0 – 12.0 | 200 | 7 - 6 | .035 | Each |
| M00547140 | 08714729790365 | Extractor Pro XL Retrieval Balloon | 12.0 – 15.0 | 200 | 7 - 6 | .035 | Each |
| M00547150 | 08714729790372 | Extractor Pro XL Retrieval Balloon | 15.0 – 18.0 | 200 | 7 - 6 | .035 | Each |



Biliary Stone Management

Stone Management (Continued)

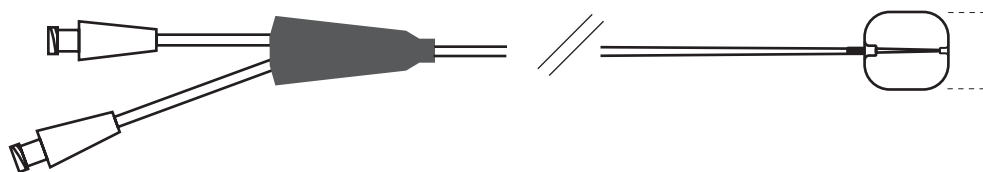

Extractor™ Pro DL Retrieval Balloons



| Order Number | GTIN | Description | Balloon Inflated O.D. (mm) | Working Length (cm) | Catheter O.D. (Fr) | Recommended Guidewire (in) | Packaging |
|--------------|----------------|------------------------------------|----------------------------|---------------------|--------------------|----------------------------|-----------|
| M00547200 | 08714729790631 | Extractor Pro DL Retrieval Balloon | 9.0 – 12.0 | 200 | 7 - 6 | .035 | Each |
| M00547210 | 08714729790655 | Extractor Pro DL Retrieval Balloon | 12.0 – 15.0 | 200 | 7 - 6 | .035 | Each |
| M00547220 | 08714729790662 | Extractor Pro DL Retrieval Balloon | 15.0 – 18.0 | 200 | 7 - 6 | .035 | Each |

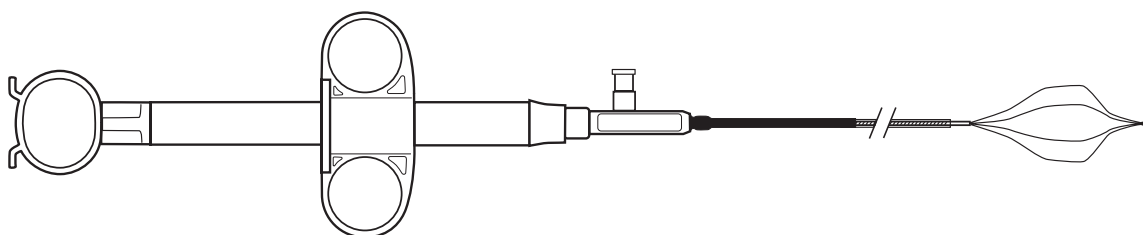

Trapezoid™ RX Wireguided Retrieval Baskets



| Order Number | GTIN | Description | Open Basket Diameter (cm) | Recommended Guidewire (in) | Required Working Channel (mm) | Packaging |
|--------------|----------------|--|---------------------------|----------------------------|-------------------------------|-----------|
| M00510860 | 08714729296379 | Trapezoid RX Wireguided Retrieval Basket | 1.5 | .035 | 3.2 | Each |
| M00510870 | 08714729296386 | Trapezoid RX Wireguided Retrieval Basket | 2.0 | .035 | 3.2 | Each |
| M00510880 | 08714729296393 | Trapezoid RX Wireguided Retrieval Basket | 2.5 | .035 | 3.2 | Each |
| M00510890* | 08714729296409 | Trapezoid RX Wireguided Retrieval Basket | 3.0 | .035 | 3.2 | Each |

Recommend Alliance™ II Inflation System for use as Mechanical Lithotripter; Order #5062, [\(Click here to view page 58\)](#).

*Refer to Instructions for Use when using this device; recommended for use with Biliary Calculi of >1.5cm.



Biliary Stone Management

CRE™ Balloon Dilators

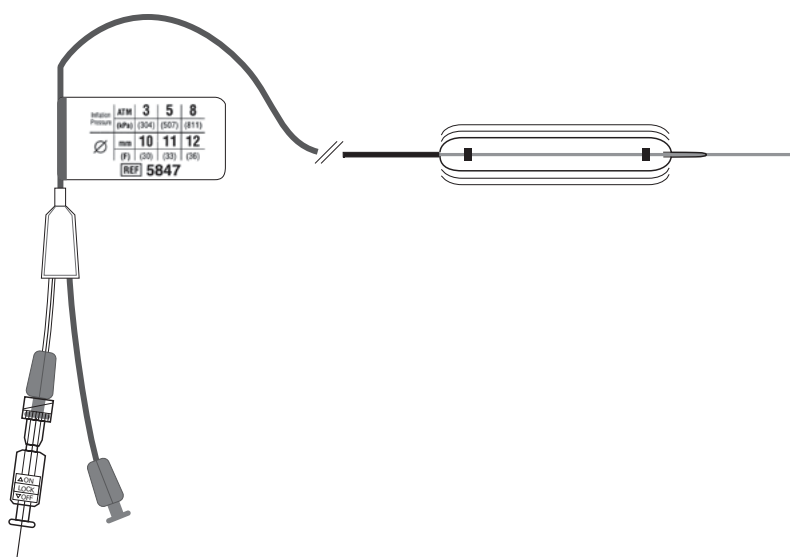

CRE Single-Use Wireguided Biliary Balloon Dilators



| Order Number | GTIN | Balloon Inflated O.D. | | Balloon Length (cm) | Inflation Pressures | | Minimum Working Channel (mm) | Catheter Size (Fr) | Working Length (cm) | Packaging |
|--------------|----------------|-----------------------|------------|---------------------|---------------------|--------------|------------------------------|--------------------|---------------------|-----------|
| | | (mm) | (Fr) | | (ATM) | (kPa) | | | | |
| M00558600 | 08714729797487 | 6-7-8 | 18-21-24 | 5.5 | 3-6-10 | 304-608-1013 | 2.8 / 3.2* / 3.2 (B1) | 7.5 | 180 | Each |
| M00558610 | 08714729797494 | 8-9-10 | 24-27-30 | 5.5 | 3-5.5-9 | 304-557-912 | 2.8 / 3.2* / 3.2 (B1) | 7.5 | 180 | Each |
| M00558620 | 08714729797500 | 10-11-12 | 30-33-36 | 5.5 | 3-5-8 | 304-507-811 | 2.8 / 3.2* / 3.2 (B1) | 7.5 | 180 | Each |
| M00558630 | 08714729797517 | 12-13.5-15 | 36-40.5-45 | 5.5 | 3-4.5-8 | 304-456-811 | 2.8 / 3.2* / 3.2 (B1) | 7.5 | 180 | Each |
| M00558640 | 08714729797524 | 15-16.5-18 | 45-49.5-54 | 5.5 | 3-4.5-7 | 304-456-709 | 2.8 / 3.2* / 3.7 / 4.2 (B2) | 7.5 | 180 | Each |
| M00558650 | 08714729797531 | 18-19-20 | 54-57-60 | 5.5 | 3-4.5-6 | 304-456-608 | 2.8 / 3.2* / 3.7 / 4.2 (B2) | 7.5 | 180 | Each |
| M00558660 | 08714729797548 | 6-7-8 | 18-21-24 | 5.5 | 3-6-10 | 304-608-1013 | 2.8 / 3.2* / 3.2 (B1) | 7.5 | 240 | Each |
| M00558670 | 08714729797555 | 8-9-10 | 24-27-30 | 5.5 | 3-5.5-9 | 304-557-912 | 2.8 / 3.2* / 3.2 (B1) | 7.5 | 240 | Each |
| M00558680 | 08714729797562 | 10-11-12 | 30-33-36 | 5.5 | 3-5-8 | 304-507-811 | 2.8 / 3.2* / 3.2 (B1) | 7.5 | 240 | Each |
| M00558690 | 08714729797579 | 12-13.5-15 | 36-40.5-45 | 5.5 | 3-4.5-8 | 304-456-811 | 2.8 / 3.2* / 3.2 (B1) | 7.5 | 240 | Each |
| M00558700 | 08714729797586 | 15-16.5-18 | 45-49.5-54 | 5.5 | 3-4.5-7 | 304-456-709 | 2.8 / 3.2* / 3.7 / 4.2 (B2) | 7.5 | 240 | Each |
| M00558710 | 08714729797593 | 18-19-20 | 54-57-60 | 5.5 | 3-4.5-6 | 304-456-608 | 2.8 / 3.2* / 3.7 / 4.2 (B2) | 7.5 | 240 | Each |

Recommended Inflation Device: Alliance™ II Integrated Inflation System Handle Order #5062, Sterile Syringe Order #5060,

[\(Click here to view page 58\).](#)

Guidewire included and preloaded in balloon catheter.

*Requires a 2.8mm Olympus™ Brand Endoscope channel or a 3.2mm Pentax™ or Fujinon™ Brand Endoscope channel.

(B1) = Indication requires ≥ 3.2mm Duodenoscope channel.

(B2) = Indication requires ≥ 4.2mm Duodenoscope channel.



Section Table of Contents

Prev Page **34** Next Page

Main Table of Contents



Biliary Stricture Management

RX Dilatation

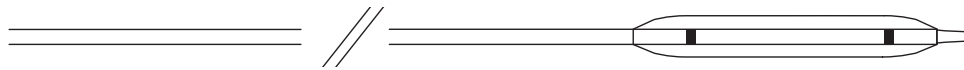

Hurricane™ RX Biliary Balloon Dilatation Catheter



| Order Number | GTIN | Balloon Inflated O.D. (mm) | Balloon Length (cm) | Catheter O.D. (Fr) | Catheter Length (cm) | Maximum Inflation Pressure (ATM) | Minimum Channel Size (mm) | Recommended Guidewire (in) | Packaging |
|--------------|----------------|----------------------------|---------------------|--------------------|----------------------|----------------------------------|---------------------------|----------------------------|-----------|
| M00545890 | 08714729283805 | 4 | 2 | 5.8 | 180 | 12 | 3.2 | .035 | Each |
| M00545900 | 08714729283812 | 4 | 4 | 5.8 | 180 | 12 | 3.2 | .035 | Each |
| M00545910 | 08714729283829 | 6 | 2 | 5.8 | 180 | 11 | 3.2 | .035 | Each |
| M00545920 | 08714729283836 | 6 | 4 | 5.8 | 180 | 11 | 3.2 | .035 | Each |
| M00545930 | 08714729283843 | 8 | 2 | 5.8 | 180 | 11 | 3.2 | .035 | Each |
| M00545940 | 08714729283850 | 8 | 4 | 5.8 | 180 | 11 | 3.2 | .035 | Each |
| M00545950 | 08714729283867 | 10 | 2 | 5.8 | 180 | 8 | 3.2 | .035 | Each |
| M00545960 | 08714729283874 | 10 | 4 | 5.8 | 180 | 8 | 3.2 | .035 | Each |



Biliary Stricture Management

RX Cytology

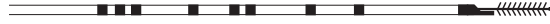

RX Cytology Brush Wireguided Cytology Brush



| Order Number | GTIN | Description | Brush Width (mm) | Catheter O.D. (Fr) | Working Length (cm) | Recommended Guidewire (in) | Packaging |
|--------------|----------------|-------------------|------------------|--------------------|---------------------|----------------------------|-----------|
| M00545000 | 08714729268628 | RX Cytology Brush | 2.1 | 8 | 200 | .035 | Each |

Biliary Dilatation

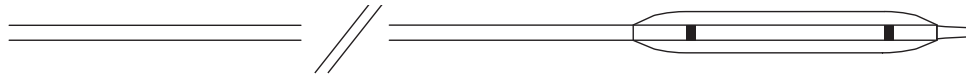

MaxForce™ Biliary Balloon Dilatation Catheter



| Order Number | GTIN | Balloon Inflated O.D. | | Balloon Length (cm) | Catheter Size | | Working Length (cm) | Required Working Channel (mm) | Recommended Guidewire (in) | Packaging |
|--------------|----------------|-----------------------|------|---------------------|---------------|------|---------------------|-------------------------------|----------------------------|-----------|
| | | (mm) | (Fr) | | (mm) | (Fr) | | | | |
| M00567330 | 08714729097037 | 4 | 12 | 2 | 1.67 | 5 | 180 | 2.8 | .035 | Each |
| M00567340 | 08714729097051 | 4 | 12 | 4 | 1.67 | 5 | 180 | 2.8 | .035 | Each |
| M00567370 | 08714729097068 | 6 | 18 | 2 | 1.67 | 5 | 180 | 2.8 | .035 | Each |
| M00567380 | 08714729097075 | 6 | 18 | 4 | 1.67 | 5 | 180 | 2.8 | .035 | Each |
| M00567410 | 08714729097082 | 8 | 24 | 2 | 1.67 | 5 | 180 | 2.8 | .035 | Each |
| M00567420 | 08714729097099 | 8 | 24 | 3 | 1.67 | 5 | 180 | 2.8 | .035 | Each |

RX Accessories

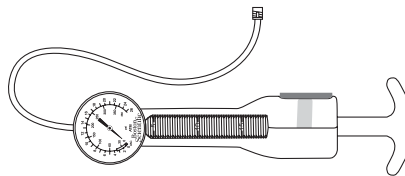

Encore™ 26 Inflation Device

| Order Number | GTIN | Description | Packaging |
|--------------|----------------|----------------------------|-----------|
| M00566670 | 08714729755241 | Encore 26 Inflation Device | Each |



Notes and Future Product Updates

Notes and Future Product Updates

Blank lined area for notes and future product updates.



SpyGlass™

Direct Visualization System

SpyGlass Direct Visualization System

| | |
|---|----|
| ➤ Disposable and Reusable Devices | 39 |
| ➤ Capital Equipment..... | 39 |

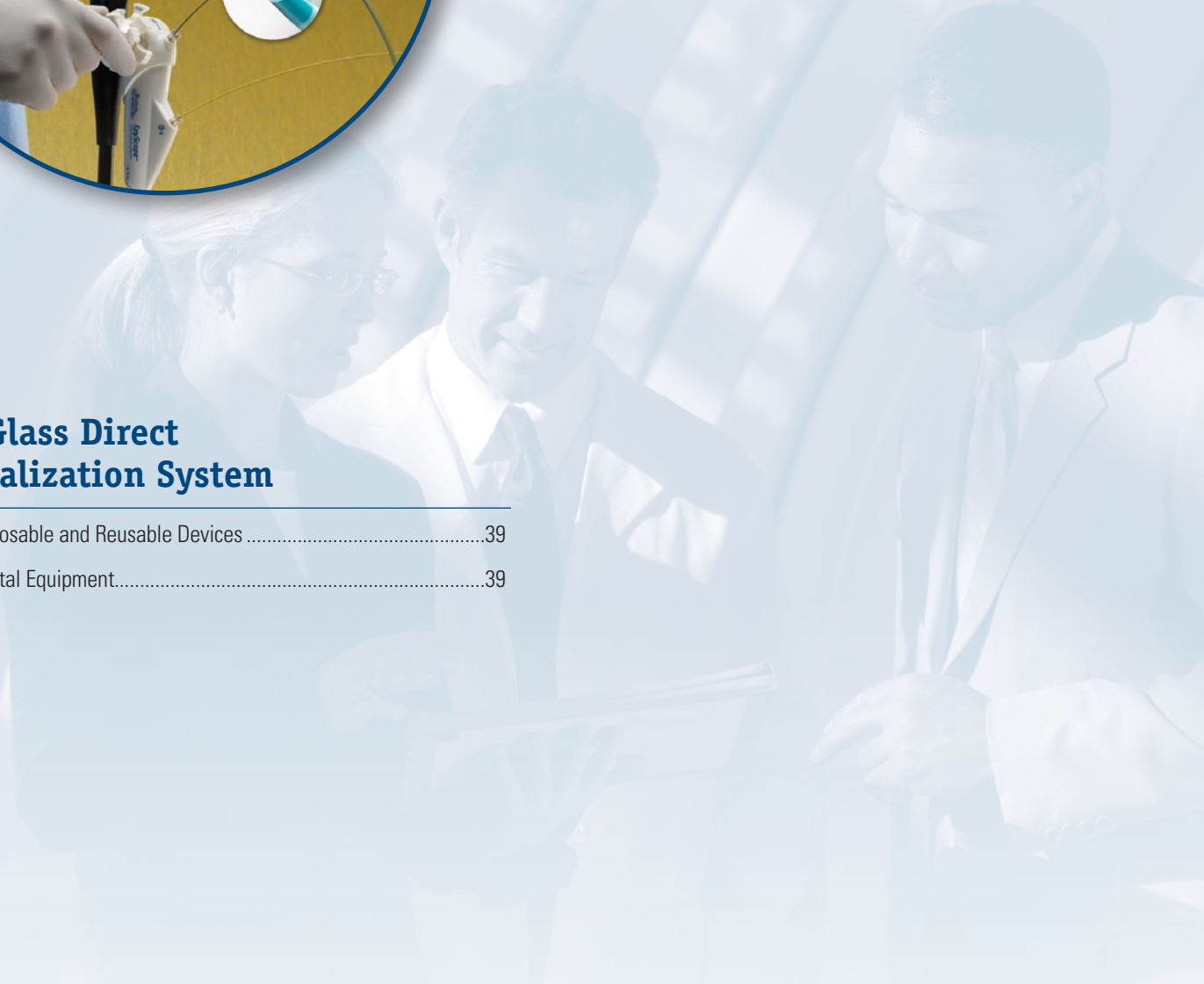

SpyGlass™ Direct Visualization System

Capital Equipment & Devices

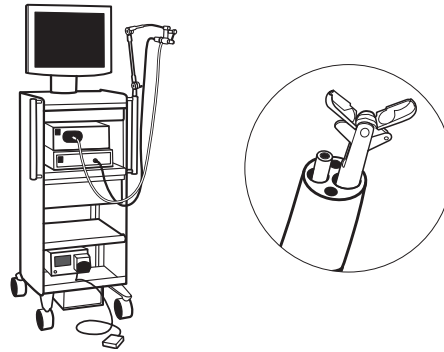

Disposable and Reusable Devices¹

| Order Number | GTIN | Description | Packaging |
|--------------|----------------|--|-----------|
| M00546030 | 08714729764441 | SpyGlass Direct Visualization Probe | Each |
| M00546230 | 08714729764434 | ⊗ SpyScope™ Access & Delivery Catheter | Each |
| M00546270 | 08714729764458 | ⊗ SpyBite™ Biopsy Forceps | Each |
| M00546451 | 08714729764854 | ⊗ SpyGlass Irrigation Tube Set | Box 10 |

Capital Equipment

| Order Number | GTIN | Description | Packaging |
|--------------|----------------|--|-----------|
| M00546100 | 08714729783664 | SpyGlass Camera | Each |
| M00546120 | 08714729773474 | SpyGlass Video Monitor | Each |
| M00546160 | 08714729779643 | SpyGlass Travel Cart ² | Each |
| M00546190 | 08714729779650 | SpyGlass Lightsource | Each |
| M00546210 | 08714729773559 | SpyGlass Light Cable | Each |
| M00546040 | 08714729773566 | SpyGlass Ocular | Each |
| M00546260 | 08714729783688 | Isolation Transformer (120V) | Each |
| M00546140 | 08714729773573 | Irrigation Pump with Foot Switch | Each |
| M00546060 | 08714729779629 | SpyGlass Storage Tray – Large ³ | Each |
| M00546050 | 08714729780250 | SpyGlass Storage Tray – Small ³ | Each |
| M00546250 | 08714729773696 | Power Cable Pack | Each |
| M00546070 | 08714729780281 | 3-Joint Arm with Clamp ² | Each |
| M00546200 | 08714729780359 | SpyGlass Lightsource Replacement Bulb | Each |

¹ The SpyScope Access and Delivery Catheter, SpyBite Forceps and Irrigation Tubing are single-use devices. The SpyGlass Direct Visualization Probe is a reusable device that has been validated up to 20 reprocessing cycles of high level disinfection. The true number of procedural uses, however, will depend on how the SpyGlass Probe is handled. Fiberoptics are very sensitive and need delicate handling.

² 3-Joint Arm (without clamp) is included with the Travel Cart (M00546160). The 3-Joint Arm with Clamp (M00546070) is useful if the account does not want to purchase the Travel Cart, as it allows the account to mount the arm to another cart or table.

³ Purchase of a minimum of two storage trays is recommended. Large storage trays (M00546060) are recommended unless account reprocesses in an Olympus™ Medivators™ Machine, into which the large storage trays will not fit. In this case, small storage trays should be ordered (M00546050).

Notes and Future Product Updates



EUS FNA

Expect™ Endoscopic Ultrasound Aspiration Needles

- Expect Endoscopic Ultrasound Aspiration Needle.....41
- Expect Slimline (SL) Endoscopic Ultrasound Aspiration Needle....41



EUS FNA

Expect™ Endoscopic Ultrasound Aspiration Needles

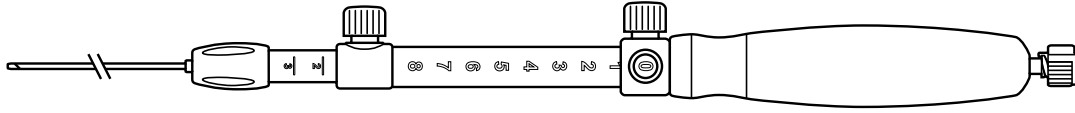

Expect Endoscopic Ultrasound Aspiration Needle



| Order Number | GTIN | Needle Size | Minimum Working Channel (mm) | Sheath Diameter (mm) | Packaging |
|--------------|----------------|---------------|------------------------------|----------------------|-----------|
| M0055000 | 08714729790051 | 19 gauge | 2.8 | 1.83 | Each |
| M00550010 | 08714729790044 | 22 gauge | 2.4 | 1.65 | Each |
| M00550020 | 08714729790020 | 25 gauge | 2.4 | 1.52 | Each |
| M00550040 | 08714729797463 | 19 gauge Flex | 2.8 | 1.73 | Each |
| M00550001 | 08714729790068 | 19 gauge | 2.8 | 1.83 | Box 5 |
| M00550011 | 08714729790013 | 22 gauge | 2.4 | 1.65 | Box 5 |
| M00550021 | 08714729790037 | 25 gauge | 2.4 | 1.52 | Box 5 |
| M00550041 | 08714729797470 | 19 gauge Flex | 2.8 | 1.73 | Box 5 |

*Packaging also includes: 20cc syringe and one-way stopcock

*Needle length: 0cm to 8cm, adjustable

*Working length: 137.5cm to 141.5cm, adjustable



Expect Slimline (SL) Endoscopic Ultrasound Aspiration Needle



| Order Number | GTIN | Needle Size | Minimum Working Channel (mm) | Sheath Diameter (mm) | Packaging |
|--------------|----------------|------------------------|------------------------------|----------------------|-----------|
| M00555500 | 08714729848141 | 19 gauge (1.10mm) | 2.8 | 1.83 | Each |
| M00555510 | 08714729848158 | 22 gauge (0.72mm) | 2.4 | 1.65 | Each |
| M00555520 | 08714729848165 | 25 gauge (0.52mm) | 2.4 | 1.52 | Each |
| M00555530 | 08714729848172 | 19 gauge Flex (1.14mm) | 2.8 | 1.73 | Each |
| M00555501 | 08714729848714 | 19 gauge (1.10mm) | 2.8 | 1.83 | Box 5 |
| M00555511 | 08714729848721 | 22 gauge (0.72mm) | 2.4 | 1.65 | Box 5 |
| M00555521 | 08714729848738 | 25 gauge (0.52mm) | 2.4 | 1.52 | Box 5 |
| M00555531 | 08714729848806 | 19 gauge Flex (1.14mm) | 2.8 | 1.73 | Box 5 |

*Packaging also includes: 20cc syringe and one-way stopcock

*Needle length: 0cm to 8cm, adjustable

*Working length: 137.5cm to 141.5cm, adjustable



Notes and Future Product Updates

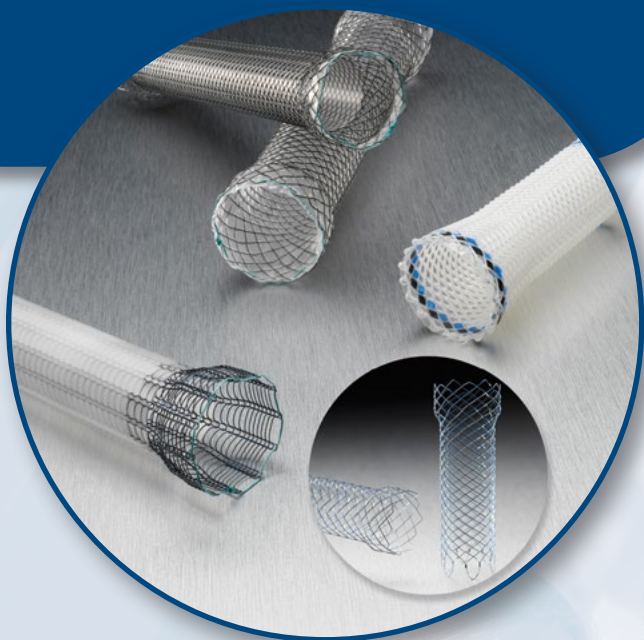

Stents (Enteral and Esophageal)

Colonic and Duodenal Stents

- ▶ Ultraflex™ Precision Single-Use Colonic Stent System.....44
- ▶ WallFlex™ Single-Use Colonic Stent System43
- ▶ WallFlex Single-Use Duodenal Stent System.....43
- ▶ WALLSTENT™ Single-Use Colonic and Duodenal Endoprosthesis with UniStep™ Plus Delivery System.....44
- ▶ WALLSTENT Super Stiff Guidewire44

Esophageal Stents

- ▶ Amplatz Super Stiff™ Guidewire.....47
- ▶ Polyflex™ Single-Use Esophageal Stent System46
- ▶ Ultraflex Single-Use Covered Esophageal NG Stent System – Distal Release.....46
- ▶ Ultraflex Single-Use Covered Esophageal NG Stent System – Proximal Release46

- ▶ Ultraflex Single-Use Covered Large Esophageal NG Stent System – Distal Release.....47
- ▶ Ultraflex Single-Use Covered Large Esophageal NG Stent System – Proximal Release47
- ▶ Ultraflex Single-Use Uncovered Esophageal NG Stent System – Distal Release.....47
- ▶ Ultraflex Single-Use Uncovered Esophageal NG Stent System – Proximal Release47
- ▶ WallFlex Fully Covered Esophageal Stent45
- ▶ WallFlex Partially Covered Esophageal Stent.....45

Enteral Stents

WallFlex™ Colonic and Duodenal Stents



 Magnetic Resonance Conditional¹

WallFlex Single-Use Colonic Stent System*



| Order Number | GTIN | Stent Body Diameter (mm) | Stent Flare Diameter (mm) | Expanded Stent Length (mm) | Working Length (cm) | Delivery System Length (cm) | Delivery System Diameter (Fr) | Packaging |
|--------------|----------------|--------------------------|---------------------------|----------------------------|---------------------|-----------------------------|-------------------------------|-----------|
| M00565040 | 08714729456513 | 25 | 30 | 60 | 230 | 270 | 10 | Each |
| M00565050 | 08714729456520 | 25 | 30 | 90 | 230 | 270 | 10 | Each |
| M00565060 | 08714729456537 | 25 | 30 | 120 | 230 | 270 | 10 | Each |
| M00565070 | 08714729456544 | 25 | 30 | 60 | 135 | 175 | 10 | Each |
| M00565080 | 08714729456551 | 25 | 30 | 90 | 135 | 175 | 10 | Each |
| M00565090 | 08714729456568 | 25 | 30 | 120 | 135 | 175 | 10 | Each |
| M00565100 | 08714729456575 | 22 | 27 | 60 | 230 | 270 | 10 | Each |
| M00565110 | 08714729456582 | 22 | 27 | 90 | 230 | 270 | 10 | Each |
| M00565120 | 08714729456599 | 22 | 27 | 120 | 230 | 270 | 10 | Each |
| M00565130 | 08714729456605 | 22 | 27 | 60 | 135 | 175 | 10 | Each |
| M00565140 | 08714729456612 | 22 | 27 | 90 | 135 | 175 | 10 | Each |
| M00565150 | 08714729456629 | 22 | 27 | 120 | 135 | 175 | 10 | Each |

*Recommended Guidewire .035" WALLSTENT™ Super Stiff Guidewire, Order #18001, [▶ \(Click here to view page 44\).](#)

¹Product with this symbol may be used in Magnetic Resonance environment according to the conditions described in Directions for Use.



 Magnetic Resonance Conditional¹

WallFlex Single-Use Duodenal Stent System*



| Order Number | GTIN | Stent Body Diameter (mm) | Flare Diameter (mm) | Expanded Stent Length (mm) | Working Length (cm) | Delivery System Length (cm) | Delivery System Diameter (Fr) | Packaging |
|--------------|----------------|--------------------------|---------------------|----------------------------|---------------------|-----------------------------|-------------------------------|-----------|
| M00565010 | 08714729456483 | 22 | 27 | 60 | 230 | 270 | 10 | Each |
| M00565020 | 08714729456490 | 22 | 27 | 90 | 230 | 270 | 10 | Each |
| M00565030 | 08714729456506 | 22 | 27 | 120 | 230 | 270 | 10 | Each |

*Recommended Guidewire .035" Hydra Jagwire™ Guidewire Stiff Shaft; or 450cm Order #5606, [▶ \(Click here to view page 3\).](#)

¹Product with this symbol may be used in Magnetic Resonance environment according to the conditions described in Directions for Use.

Enteral Stents

WALLSTENT™ Colonic and Duodenal Stents (Continued)

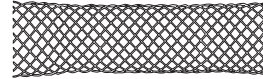
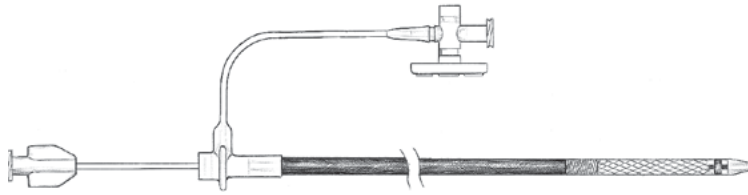

 Magnetic Resonance Conditional¹

WALLSTENT Single-Use Colonic & Duodenal Endoprosthesis with UniStep™ Plus Delivery System*



| Order Number | GTIN | Expanded Stent Diameter (mm) | Expanded Stent Length (mm) | Working Length (cm) | Delivery System Length (cm) | Delivery System Diameter (Fr) | Packaging |
|--------------|----------------|------------------------------|----------------------------|---------------------|-----------------------------|-------------------------------|-----------|
| M00565560 | 08714729285052 | 20 | 60 | 230 | 255 | 10 | Each |
| M00565570 | 08714729285069 | 20 | 90 | 230 | 255 | 10 | Each |
| M00565580 | 08714729285076 | 22 | 60 | 230 | 255 | 10 | Each |
| M00565590 | 08714729285083 | 22 | 90 | 230 | 255 | 10 | Each |
| M00565620 | 08714729285113 | 20 | 60 | 135 | 160 | 10 | Each |
| M00565630 | 08714729285120 | 20 | 90 | 135 | 160 | 10 | Each |
| M00565640 | 08714729285137 | 22 | 60 | 135 | 160 | 10 | Each |
| M00565650 | 08714729285144 | 22 | 90 | 135 | 160 | 10 | Each |

*Recommended Guidewire .035" WALLSTENT Super Stiff Guidewire, Order #18001, (see below).

¹Product with this symbol may be used in Magnetic Resonance environment according to the conditions described in Directions for Use.

WALLSTENT Super Stiff Guidewire



| Order Number | GTIN | Description | Distal Tip O.D. (in) | Length (cm) | Tip Style | Packaging |
|--------------|----------------|---------------------------------|----------------------|-------------|-----------|-----------|
| H965180011 | 08714729203070 | WALLSTENT Super Stiff Guidewire | .035 | 500 | Tapered | Box 5 |

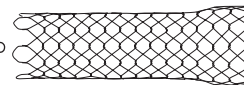

 Magnetic Resonance Conditional¹

Ultraflex™ Precision Single-Use Colonic Stent System*



| Order Number | GTIN | Stent Body Diameter (mm) | Stent Flare Diameter (mm) | Expanded Stent Length (mm) | Working Length (cm) | Delivery System Length (cm) | Delivery Tip Diameter (Fr) | Packaging |
|--------------|----------------|--------------------------|---------------------------|----------------------------|---------------------|-----------------------------|----------------------------|-----------|
| M00557330 | 08714729339175 | 25 | 30 | 57 | 100 | 105 | 22 | Each |
| M00557360 | 08714729339199 | 25 | 30 | 87 | 100 | 105 | 22 | Each |
| M00557380 | 08714729339205 | 25 | 30 | 117 | 100 | 105 | 22 | Each |

*Recommended Guidewire .038" Jagwire™ Guidewire, Order #5662, [\(Click here to view page 4\)](#).

¹Product with this symbol may be used in Magnetic Resonance environment according to the conditions described in Directions for Use.

Esophageal Stents

WallFlex™ Esophageal Stents

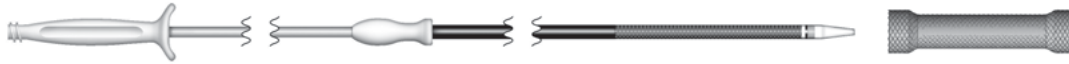

 Magnetic Resonance Conditional¹

WallFlex Fully Covered Esophageal Stent*



| Order Number | GTIN | Stent O.D. (mm) | Proximal / Distal Flares O.D. (mm) | Stent Length (cm) | Catheter Diameter (Fr / mm) | Working Length (cm) | Packaging |
|--------------|----------------|-----------------|------------------------------------|-------------------|-----------------------------|---------------------|-----------|
| M00516700 | 08714729778035 | 18 | 25 / 23 | 10.3 | 18.5 / 6.17 | 78 | Each |
| M00516710 | 08714729778042 | 18 | 25 / 23 | 12.3 | 18.5 / 6.17 | 78 | Each |
| M00516720 | 08714729778059 | 18 | 25 / 23 | 15.3 | 18.5 / 6.17 | 78 | Each |
| M00516730 | 08714729778066 | 23 | 28 / 28 | 10.5 | 18.5 / 6.17 | 78 | Each |
| M00516740 | 08714729778073 | 23 | 28 / 28 | 12.5 | 18.5 / 6.17 | 78 | Each |
| M00516750 | 08714729778080 | 23 | 28 / 28 | 15.5 | 18.5 / 6.17 | 78 | Each |

*Recommended Guidewire .038" Jagwire™ Guidewire, Order #5662. [\(Click here to view page 4\).](#)

¹Product with this symbol may be used in Magnetic Resonance environment according to the conditions described in Directions for Use.

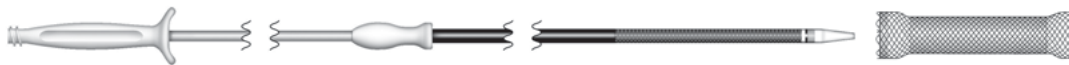

 Magnetic Resonance Conditional¹

WallFlex Partially Covered Esophageal Stent*



| Order Number | GTIN | Stent O.D. (mm) | Proximal / Distal Flares O.D. (mm) | Stent Length (cm) | Covered Length (cm) | Catheter Diameter (Fr / mm) | Working Length (cm) | Packaging |
|--------------|----------------|-----------------|------------------------------------|-------------------|---------------------|-----------------------------|---------------------|-----------|
| M00516900 | 08714729765240 | 18 | 23 / 23 | 10.3 | 7 | 18.5 / 6.17 | 78 | Each |
| M00516910 | 08714729765257 | 18 | 23 / 23 | 12.3 | 9 | 18.5 / 6.17 | 78 | Each |
| M00516920 | 08714729765264 | 18 | 23 / 23 | 15.3 | 12 | 18.5 / 6.17 | 78 | Each |
| M00516930 | 08714729765271 | 23 | 28 / 28 | 10.5 | 7 | 18.5 / 6.17 | 78 | Each |
| M00516940 | 08714729765288 | 23 | 28 / 28 | 12.5 | 9 | 18.5 / 6.17 | 78 | Each |
| M00516950 | 08714729765295 | 23 | 28 / 28 | 15.5 | 12 | 18.5 / 6.17 | 78 | Each |

*Recommended Guidewire .038" Jagwire Guidewire, Order #5662. [\(Click here to view page 4\).](#)

¹Product with this symbol may be used in Magnetic Resonance environment according to the conditions described in Directions for Use.

Esophageal Stents

Polyflex™ Stents

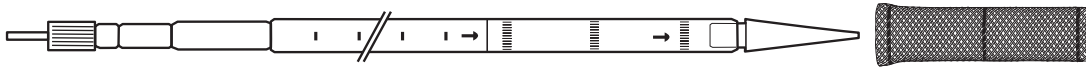

Polyflex Single-Use Esophageal Stent System*



| Order Number | GTIN | Stent I.D. (mm) | Proximal Flare I.D. (mm) | Stent Length (mm) | Delivery System Diameter (mm) | Packaging |
|--------------|----------------|-----------------|--------------------------|-------------------|-------------------------------|-----------|
| M00514270 | 08714729457015 | 16 | 20 | 90 | 12 | Each |
| M00514280 | 08714729457022 | 16 | 20 | 120 | 12 | Each |
| M00514290 | 08714729457039 | 16 | 20 | 150 | 12 | Each |
| M00514300 | 08714729457046 | 18 | 23 | 90 | 13 | Each |
| M00514310 | 08714729457053 | 18 | 23 | 120 | 13 | Each |
| M00514320 | 08714729457060 | 18 | 23 | 150 | 13 | Each |
| M00514330 | 08714729457077 | 21 | 25 | 90 | 14 | Each |
| M00514340 | 08714729457084 | 21 | 25 | 120 | 14 | Each |
| M00514350 | 08714729457091 | 21 | 25 | 150 | 14 | Each |

*Recommended Guidewire .038" Jagwire™ Guidewire, Order #5662, [▶ \(Click here to view page 4\).](#)

Ultraflex™ Stents

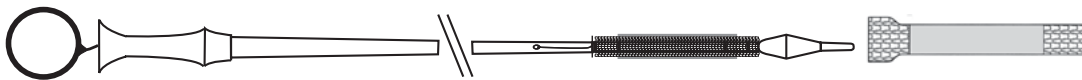

Ultraflex Single-Use Covered Esophageal NG Stent System – Distal Release*



| Order Number | GTIN | Stent O.D. (mm) | Proximal Flare O.D. (mm) | Stent Length (cm) | Covered Length (cm) | Packaging |
|--------------|----------------|-----------------|--------------------------|-------------------|---------------------|-----------|
| M00513730 | 08714729716150 | 18 | 23 | 10 | 7 | Each |
| M00513740 | 08714729716167 | 18 | 23 | 12 | 9 | Each |
| M00513750 | 08714729649113 | 18 | 23 | 15 | 12 | Each |

*Recommended Guidewire .038" Jagwire Guidewire, Order #5662, [▶ \(Click here to view page 4\).](#)

[†]Product with this symbol may be used in Magnetic Resonance environment according to the conditions described in Directions for Use.



Ultraflex Single-Use Covered Esophageal NG Stent System – Proximal Release*



| Order Number | GTIN | Stent O.D. (mm) | Proximal Flare O.D. (mm) | Stent Length (cm) | Covered Length (cm) | Packaging |
|--------------|----------------|-----------------|--------------------------|-------------------|---------------------|-----------|
| M00513840 | 08714729716099 | 18 | 23 | 10 | 7 | Each |
| M00513850 | 08714729716075 | 18 | 23 | 12 | 9 | Each |
| M00513860 | 08714729716082 | 18 | 23 | 15 | 12 | Each |

*Recommended Guidewire .038" Jagwire Guidewire, Order #5662, [▶ \(Click here to view page 4\).](#) Visible endoscopic proximal marker.

[†]Product with this symbol may be used in Magnetic Resonance environment according to the conditions described in Directions for Use.

Esophageal Stents

Ultraflex™ Stents (Continued)

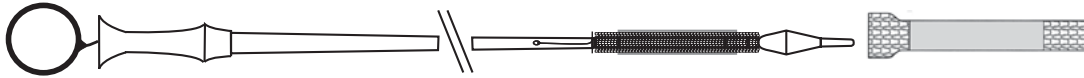

 Magnetic Resonance Conditional¹

Ultraflex Single-Use Covered Large Esophageal NG Stent System – Distal Release*



| Order Number | GTIN | Stent O.D. (mm) | Proximal Flare O.D. (mm) | Stent Length (cm) | Covered Length (cm) | Packaging |
|--------------|----------------|-----------------|--------------------------|-------------------|---------------------|-----------|
| M00514200 | 08714729121190 | 23 | 28 | 10 | 7 | Each |
| M00514210 | 08714729121206 | 23 | 28 | 12 | 9 | Each |

*Recommended Guidewire .038" Jagwire™ Guidewire, Order #5662, [▶ \(Click here to view page 4\).](#)

¹Product with this symbol may be used in Magnetic Resonance environment according to the conditions described in Directions for Use.

 Magnetic Resonance Conditional¹

Ultraflex Single-Use Covered Large Esophageal NG Stent System – Proximal Release*



| Order Number | GTIN | Stent O.D. (mm) | Proximal Flare O.D. (mm) | Stent Length (cm) | Covered Length (cm) | Packaging |
|--------------|----------------|-----------------|--------------------------|-------------------|---------------------|-----------|
| M00514240 | 08714729716105 | 23 | 28 | 10 | 7 | Each |
| M00514250 | 08714729716112 | 23 | 28 | 12 | 9 | Each |

*Recommended Guidewire .038" Jagwire Guidewire, Order #5662, (See page 4). Visible endoscopic proximal marker.

¹Product with this symbol may be used in Magnetic Resonance environment according to the conditions described in Directions for Use.

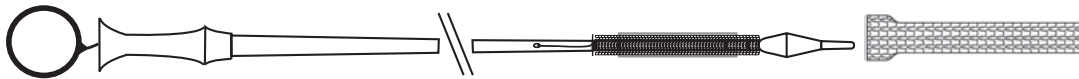

 Magnetic Resonance Conditional¹

Ultraflex Single-Use Uncovered Esophageal NG Stent System – Distal Release*



| Order Number | GTIN | Stent O.D. (mm) | Proximal Flare O.D. (mm) | Stent Length (cm) | Packaging |
|--------------|----------------|-----------------|--------------------------|-------------------|-----------|
| M00513700 | 08714729716129 | 18 | 23 | 7 | Each |
| M00513710 | 08714729716136 | 18 | 23 | 10 | Each |
| M00513720 | 08714729716143 | 18 | 23 | 15 | Each |

*Recommended Guidewire .038" Jagwire Guidewire, Order #5662, [▶ \(Click here to view page 4\).](#)

¹Product with this symbol may be used in Magnetic Resonance environment according to the conditions described in Directions for Use.

 Magnetic Resonance Conditional¹

Ultraflex Single-Use Uncovered Esophageal NG Stent System – Proximal Release*



| Order Number | GTIN | Stent O.D. (mm) | Proximal Flare O.D. (mm) | Stent Length (cm) | Packaging |
|--------------|----------------|-----------------|--------------------------|-------------------|-----------|
| M00513800 | 08714729716174 | 18 | 23 | 7 | Each |
| M00513810 | 08714729716181 | 18 | 23 | 10 | Each |
| M00513830 | 08714729716204 | 18 | 23 | 15 | Each |

*Recommended Guidewire .038" Jagwire Guidewire, Order #5662, [▶ \(Click here to view page 4\).](#)

¹Product with this symbol may be used in Magnetic Resonance environment according to the conditions described in Directions for Use.

Amplatz Super Stiff™ Guidewire



| Order Number | GTIN | Description | O.D. (in) | Length (cm) | Tip Style | Packaging |
|--------------|----------------|-------------------------------|-----------|-------------|-----------|-----------|
| M00550090 | 08714729301929 | Amplatz Super Stiff Guidewire | .038 | 260 | Straight | Each |

Notes and Future Product Updates



Hemostasis

Hemostasis

Clipping Devices

- ▶ Resolution™ Clip49

Bipolar Electrohemostasis Catheters

- ▶ Gold Probe™ Single-Use Electrohemostasis Catheters49
- ▶ Injection Gold Probe™ Single-Use Electrohemostasis / Injection Catheters49

Needles

- ▶ Interject™ Clear Single-Use Injection Therapy Needle Catheters50
- ▶ Interject Contrast Single-Use Injection Therapy Needle Catheters50
- ▶ Optiflo™ Single-Use Hemostasis Catheters51

Multiple Band Ligators

- ▶ Speedband Superview Super 7™ Multiple Band Ligators51

Generator

- ▶ Endostat™ III Bipolar / Monopolar Electrosurgical Generator52
- ▶ Endostat Generator Accessories52

Electrosurgical Bipolar Cable Adapter

- ▶ Electrosurgical Bipolar Cable Adapter53

Hemostasis

Clipping Devices

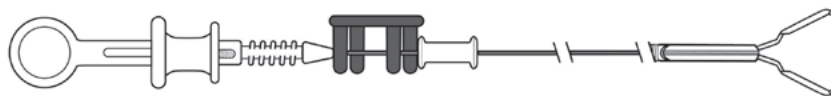

 Magnetic Resonance Conditional*

Resolution™ Clip

| Order Number | GTIN | Working Length (cm) | Minimum Working Channel (mm) | Clip Opening (mm) | Packaging |
|--------------|----------------|---------------------|------------------------------|-------------------|-----------|
| M00522600 | 08714729504764 | 155 | 2.8 | 11 | Each |
| M00522601 | 08714729504771 | 155 | 2.8 | 11 | Box 10 |
| M00522602 | 08714729504788 | 155 | 2.8 | 11 | Box 20 |
| M00522610 | 08714729504795 | 235 | 2.8 | 11 | Each |
| M00522611 | 08714729504801 | 235 | 2.8 | 11 | Box 10 |
| M00522612 | 08714729504818 | 235 | 2.8 | 11 | Box 20 |

*Product with this symbol may be used in Magnetic Resonance environment according to the conditions described in Directions for Use.

Bipolar Electrohemostasis Catheters

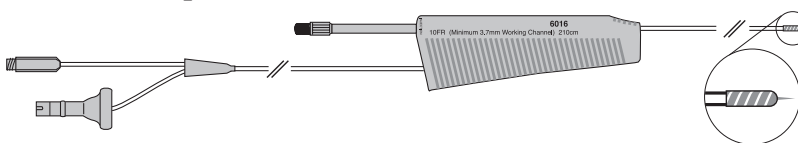

Injection Gold Probe™ Single-Use Electrohemostasis / Injection Catheters

| Order Number | GTIN | Description | O.D. (Fr) | Needle Size Gauge | Working Length (cm) | Type Generator / Connector | Packaging |
|--------------|----------------|-------------------------------|-----------|-------------------|---------------------|----------------------------|-----------|
| M00560150 | 08714729056492 | Injection Gold Probe Catheter | 7 | 25 | 210 | Standard Plug* | Each |
| M00560160 | 08714729056508 | Injection Gold Probe Catheter | 10 | 25 | 210 | Standard Plug* | Each |

*Compatible with Endostat™ Bipolar-Monopolar Electrosurgical Generators.

For connections to other generators, please refer to the Electrosurgical Bipolar Cable Adapters,  (Click here to view page 52).

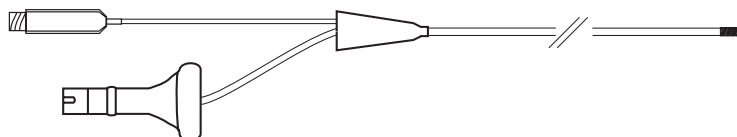

Gold Probe™ Single-Use Electrohemostasis Catheters

| Order Number | GTIN | Description | O.D. (Fr) | Working Length (cm) | Type Generator / Connector | Packaging |
|--------------|----------------|---------------------|-----------|---------------------|----------------------------|-----------|
| M00560070 | 08714729174691 | Gold Probe Catheter | 7 | 300 | Standard Plug* | Each |
| M00560100 | 08714729174684 | Gold Probe Catheter | 10 | 300 | Standard Plug* | Each |
| M00560220 | 08714729099574 | Gold Probe Catheter | 7 | 350 | Standard Plug* | Each |
| M00560071 | 08714729071013 | Gold Probe Catheter | 7 | 300 | Standard Plug* | Box 5 |
| M00560101 | 08714729071020 | Gold Probe Catheter | 10 | 300 | Standard Plug* | Box 5 |

*Compatible with Endostat Bipolar-Monopolar Electrosurgical Generators.

For connections to other generators, please refer to the Electrosurgical Bipolar Cable Adapters,  (Click here to view page 52).



Hemostasis

Needles

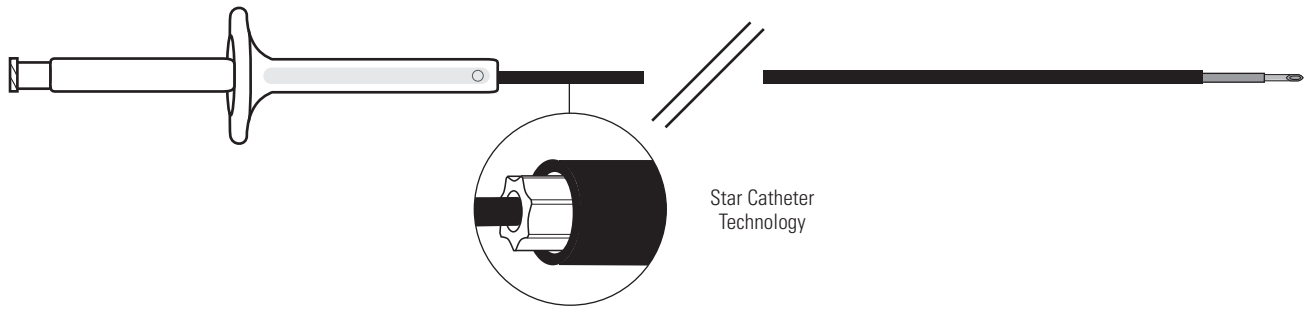

Interject™ Contrast Single-Use Injection Therapy Needle Catheters*



| Order Number | GTIN | Sheath Design | Needle Gauge | Maximum Needle Extension Length (mm) | Sheath O.D. (mm) | Working Length (cm) | Packaging |
|--------------|----------------|---------------|--------------|--------------------------------------|------------------|---------------------|-----------|
| M00518151 | 08714729296430 | Contrast | 23 | 4 | 1.8 | 200 | Box 5 |
| M00518161 | 08714729296447 | Contrast | 25 | 4 | 1.8 | 200 | Box 5 |
| M00518251 | 08714729296478 | Contrast | 23 | 6 | 1.8 | 200 | Box 5 |
| M00518261 | 08714729296485 | Contrast | 25 | 6 | 1.8 | 200 | Box 5 |
| M00518351 | 08714729296522 | Contrast | 23 | 4 | 2.3 | 240 | Box 5 |
| M00518361 | 08714729296539 | Contrast | 25 | 4 | 2.3 | 240 | Box 5 |

*With Star Catheter™ Technology.

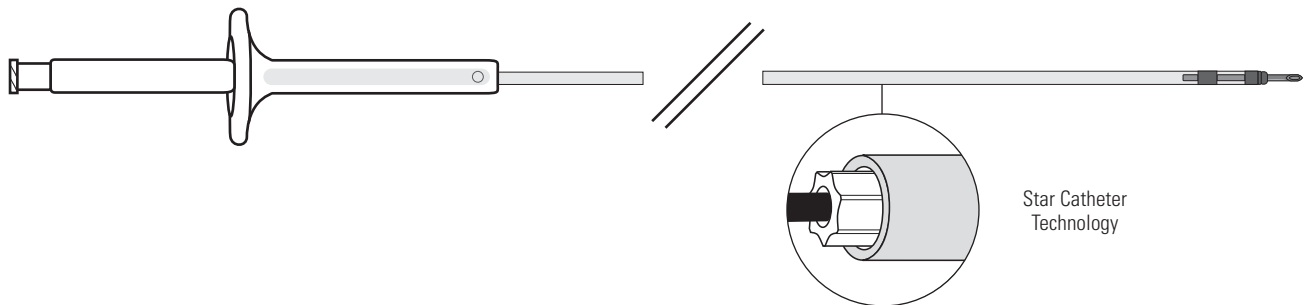

Interject Clear Single-Use Injection Therapy Needle Catheters*



| Order Number | GTIN | Sheath Design | Needle Gauge | Maximum Needle Extension Length (mm) | Sheath O.D. (mm) | Working Length (cm) | Packaging |
|--------------|----------------|---------------|--------------|--------------------------------------|------------------|---------------------|-----------|
| M00518101 | 08714729296416 | Clear | 23 | 4 | 1.8 | 200 | Box 5 |
| M00518111 | 08714729296423 | Clear | 25 | 4 | 1.8 | 200 | Box 5 |
| M00518301 | 08714729296508 | Clear | 23 | 4 | 2.3 | 240 | Box 5 |
| M00518311 | 08714729296515 | Clear | 25 | 4 | 2.3 | 240 | Box 5 |

*With Star Catheter Technology.

Hemostasis

Needles (Continued)

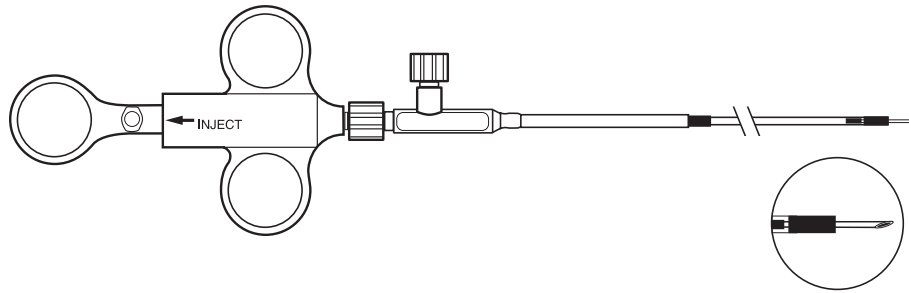

Optiflo™ Single-Use Hemostasis Catheters



| Order Number | GTIN | Description | Needle Gauge | Sheath O.D. (mm) | Working Length (cm) | Working Channel (mm) | Packaging |
|--------------|----------------|------------------|--------------|------------------|---------------------|----------------------|-----------|
| M00511731 | 08714729144182 | Optiflo Catheter | 23 | 2.3 | 200 | 2.8 | Box 5 |
| M00511751 | 08714729145264 | Optiflo Catheter | 25 | 2.3 | 200 | 2.8 | Box 5 |

Multiple Band Ligators

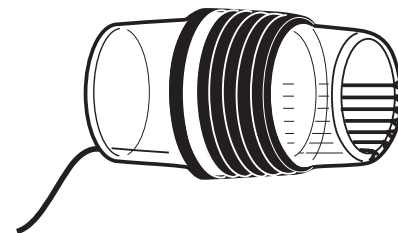
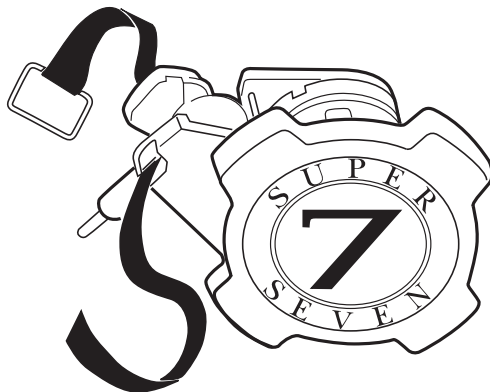

Speedband Superview Super 7™ Multiple Band Ligators



| Order Number | GTIN | Description | Required Working Channel (mm) | Scope O.D. (mm) | Bands / Ligating Unit | Packaging |
|--------------|----------------|--|-------------------------------|-----------------|-----------------------|-----------|
| M00542251 | 08714729201960 | Speedband Superview Super 7 Band Ligator | 2.8 | 8.6 – 11.5 | 7 | Box 2 |
| M00542253 | 08714729504832 | Speedband Superview Super 7 Band Ligator | 2.8 | 8.6 – 11.5 | 7 | Box 4 |



Hemostasis

Generator

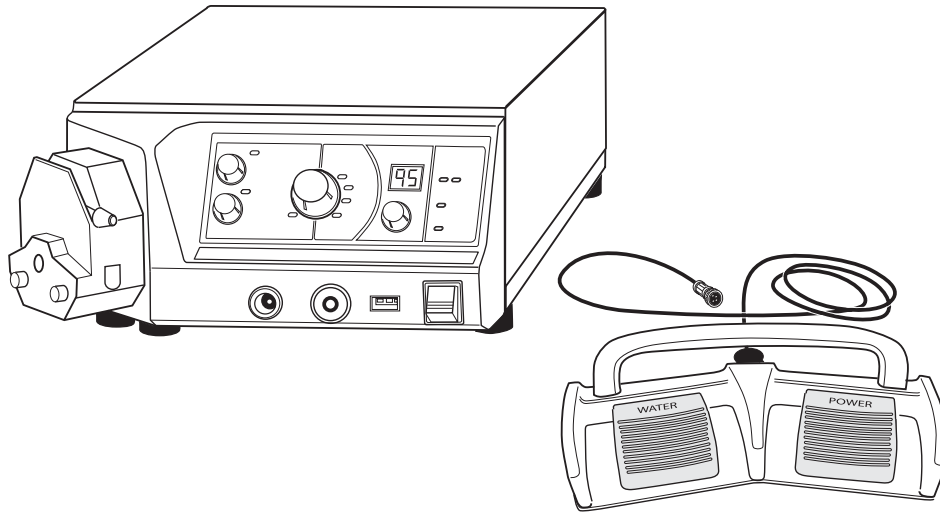

Endostat™ III Bipolar / Monopolar Electrosurgical Generator

| Order Number | Description | Packaging |
|--------------|--|-----------|
| M00540200 | Endostat III Bipolar / Monopolar Electrosurgical Generator <ul style="list-style-type: none"> – Power Cord w/ I.E.C. Molded Plug – Footswitch – Water Bottle – Pump Tubing (spare) – Fuse (spare) – Operating Manual | Each |

Endostat Generator Accessories

| Order Number | Description | Packaging |
|--------------|---|-----------|
| M00540720 | Water Bottle | Each |
| M00540240 | Endostat III Dual Footswitch | Each |
| M00540760 | Power Cord w/ I.E.C. Molded Plug | Each |
| M00540771 | E-Z Load Pump Tubing – Endostat III Generator (for generators w/ E-Z Load Pump) | Box 5 |

Hemostasis

Electrosurgical Bipolar Cable Adapter

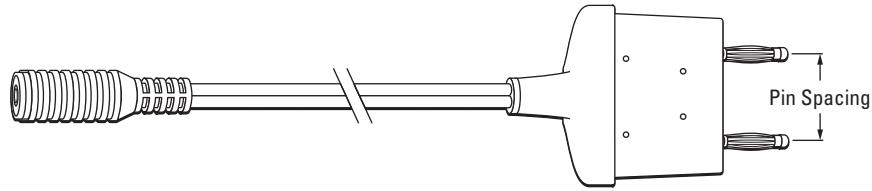

Electrosurgical Bipolar Cable Adapter*

| Order Number | Description | Pin Spacing (mm) | Generator Compatibility** | Packaging |
|--------------|-----------------------|------------------|---|-----------|
| M00561440 | Bipolar Cable Adapter | 18 | EMC (Coagulasem Dolley) | Each |
| M00561450 | Bipolar Cable Adapter | 22 | ERBE, EMC Dolley, Olympus™ (ESG100 & PSD60) | Each |
| M00561460 | Bipolar Cable Adapter | 25 | Lamidey (Optima 4) | Each |
| M00561470 | Bipolar Cable Adapter | 28 | Valleylab™, Lamidey (Duo), Bovie™ (Aaron 3250™), Olympus (UES10, UES30 & Surgemaster), Bowa, Soring | Each |
| M00561480 | Bipolar Cable Adapter | 28 / Third Pin | ConMed™ (System 5000), Bovie (Aaron 2250™), Ethicon™ | Each |
| M00561490 | Bipolar Cable Adapter | 32 / Third Pin | ConMed (Sabre 180, Excalibur, System 7550) | Each |
| M00561500 | Bipolar Cable Adapter | 39 | Codman, Malis™ | Each |

*Bipolar Cable Adapters are used to connect Gold Probe™ and Injection Gold Probe™ Catheters with the above mentioned generators.

Bipolar Cable Adapters are not required for the connection of Gold Probe and Injection Gold Probe to Endostat™ II or III Generators.

** For generators and their associated cable adaptors not listed above, please contact your Boston Scientific Representative.

Note: Monopolar active cords are in the Polypectomy Section, [Click here to view page 74](#).

Note: Some variations in generator faceplates may exist within a generator model. We recommend that you confirm pin spacing prior to ordering.

Notes and Future Product Updates



Dilation

CRE™ Balloon Dilators

| | |
|---|----|
| ➤ CRE Single-Use Fixed Wire Esophageal Balloon Dilators | 55 |
| ➤ CRE Single-Use Wireguided Esophageal / Pyloric / Biliary Balloon Dilators | 55 |
| ➤ CRE Single-Use Wireguided Esophageal / Pyloric / Colonic / Biliary Balloon Dilators | 56 |
| ➤ CRE Single-Use Wireguided Esophageal / Pyloric Balloon Dilators | 59 |
| ➤ CRE Single-Use Wireguided Esophageal / Pyloric / Colonic Balloon Dilators | 59 |

MaxForce TTS™ Esophageal High Performance Balloon Dilatation Catheter

| | |
|--|----|
| ➤ MaxForce TTS Esophageal High Performance Balloon Dilatation Catheter | 57 |
|--|----|

Rigiflex™ II Single-Use Achalasia Balloon Dilators

| | |
|---|----|
| ➤ Rigiflex II Single-Use Achalasia Balloon Dilators | 57 |
|---|----|

Inflation Systems

| | |
|---------------------------------------|----|
| ➤ Alliance™ II Inflation System | 58 |
|---------------------------------------|----|

Dilation Accessories

| | |
|---|----|
| ➤ Inflation / Deflation Devices and Accessories | 58 |
|---|----|

Dilation

CRE™ Balloon Dilators

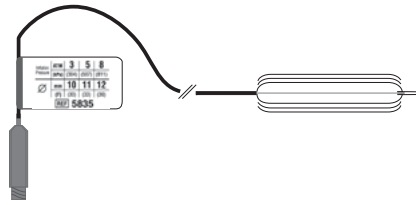

CRE Single-Use Fixed Wire Esophageal Balloon Dilators



| Order Number | GTIN | Balloon Inflated O.D. | | Balloon Length (cm) | Inflation Pressures | | Minimum Working Channel (mm) | Catheter Size (Fr) | Working Length (cm) | Packaging |
|--------------|----------------|-----------------------|------------|---------------------|---------------------|--------------|------------------------------|--------------------|---------------------|-----------|
| | | (mm) | (Fr) | | (ATM) | (kPa) | | | | |
| M00558330 | 08714729201984 | 6-7-8 | 18-21-24 | 8 | 3-6-10 | 304-608-1013 | 2.8 | 6 | 180 | Each |
| M00558340 | 08714729201991 | 8-9-10 | 24-27-30 | 8 | 3-5.5-9 | 304-557-912 | 2.8 | 6 | 180 | Each |
| M00558350 | 08714729202004 | 10-11-12 | 30-33-36 | 8 | 3-5-8 | 304-507-811 | 2.8 | 6 | 180 | Each |
| M00558360 | 08714729195986 | 12-13.5-15 | 36-40.5-45 | 8 | 3-4.5-8 | 304-456-811 | 2.8 | 6 | 180 | Each |
| M00558370 | 08714729195993 | 15-16.5-18 | 45-49.5-54 | 8 | 3-4.5-7 | 304-456-709 | 2.8 | 6 | 180 | Each |
| M00558380 | 08714729202011 | 18-19-20 | 54-57-60 | 8 | 3-4.5-6 | 304-456-608 | 2.8 | 6 | 180 | Each |
| M00558361 | 08714729339298 | 12-13.5-15 | 36-40.5-45 | 8 | 3-4.5-8 | 304-456-811 | 2.8 | 6 | 180 | Box 5 |
| M00558371 | 08714729339304 | 15-16.5-18 | 45-49.5-54 | 8 | 3-4.5-7 | 304-456-709 | 2.8 | 6 | 180 | Box 5 |
| M00558381 | 08714729339311 | 18-19-20 | 54-57-60 | 8 | 3-4.5-6 | 304-456-608 | 2.8 | 6 | 180 | Box 5 |

Recommended Inflation Device: Alliance™ II Integrated Inflation System Handle Order #5062, Sterile Syringe Order #5060,

[\(Click here to view page 58\).](#)

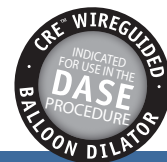
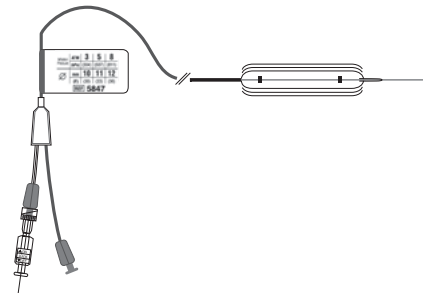

CRE Single-Use Wireguided Esophageal / Pyloric / Biliary Balloon Dilators



| Order Number | GTIN | Balloon Inflated O.D. | | Balloon Length (cm) | Inflation Pressures | | Minimum Working Channel (mm) | Catheter Size (Fr) | Working Length (cm) | Packaging |
|--------------|----------------|-----------------------|------------|---------------------|---------------------|--------------|------------------------------|--------------------|---------------------|-----------|
| | | (mm) | (Fr) | | (ATM) | (kPa) | | | | |
| M00558600 | 08714729797487 | 6-7-8 | 18-21-24 | 5.5 | 3-6-10 | 304-608-1013 | 2.8 / 3.2* / 3.2 (B1) | 7.5 | 180 | Each |
| M00558610 | 08714729797494 | 8-9-10 | 24-27-30 | 5.5 | 3-5.5-9 | 304-557-912 | 2.8 / 3.2* / 3.2 (B1) | 7.5 | 180 | Each |
| M00558620 | 08714729797500 | 10-11-12 | 30-33-36 | 5.5 | 3-5-8 | 304-507-811 | 2.8 / 3.2* / 3.2 (B1) | 7.5 | 180 | Each |
| M00558630 | 08714729797517 | 12-13.5-15 | 36-40.5-45 | 5.5 | 3-4.5-8 | 304-456-811 | 2.8 / 3.2* / 3.2 (B1) | 7.5 | 180 | Each |
| M00558640 | 08714729797524 | 15-16.5-18 | 45-49.5-54 | 5.5 | 3-4.5-7 | 304-456-709 | 2.8 / 3.2* / 3.7 / 4.2 (B2) | 7.5 | 180 | Each |
| M00558650** | 08714729797531 | 18-19-20 | 54-57-60 | 5.5 | 3-4.5-6 | 304-456-608 | 2.8 / 3.2* / 3.7 / 4.2 (B2) | 7.5 | 180 | Each |

Recommended Inflation Device: Alliance II Integrated Inflation System Handle Order #5062, Sterile Syringe Order #5060,

[\(Click here to view page 58\).](#)

Guidewire included and preloaded in balloon catheter.

*Requires a 2.8mm Olympus™ Brand Endoscope channel or a 3.2mm Pentax™ or Fujinon™ Brand Endoscope channel.

**Esophageal and Biliary application only.

(B1) = Indication requires ≥ 3.2mm Duodenoscope channel.

(B2) = Indication requires ≥ 4.2mm Duodenoscope channel.

Dilation

CRE™ Balloon Dilators (Continued)

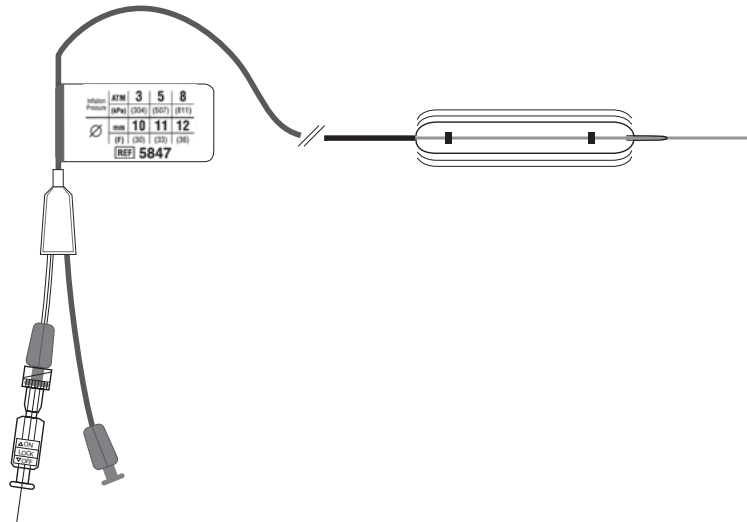

CRE Single-Use Wireguided Esophageal / Pyloric / Colonic / Biliary Balloon Dilators



| Order Number | GTIN | Balloon Inflated O.D. | | Balloon Length (cm) | Inflation Pressures | | Minimum Working Channel (mm) | Catheter Size (Fr) | Working Length (cm) | Packaging |
|--------------|----------------|-----------------------|------------|---------------------|---------------------|--------------|------------------------------|--------------------|---------------------|-----------|
| | | (mm) | (Fr) | | (ATM) | (kPa) | | | | |
| M00558660 | 08714729797548 | 6-7-8 | 18-21-24 | 5.5 | 3-6-10 | 304-608-1013 | 2.8 / 3.2* / 3.2 (B1) | 7.5 | 240 | Each |
| M00558670 | 08714729797555 | 8-9-10 | 24-27-30 | 5.5 | 3-5.5-9 | 304-557-912 | 2.8 / 3.2* / 3.2 (B1) | 7.5 | 240 | Each |
| M00558680 | 08714729797562 | 10-11-12 | 30-33-36 | 5.5 | 3-5-8 | 304-507-811 | 2.8 / 3.2* / 3.2 (B1) | 7.5 | 240 | Each |
| M00558690 | 08714729797579 | 12-13.5-15 | 36-40.5-45 | 5.5 | 3-4.5-8 | 304-456-811 | 2.8 / 3.2* / 3.2 (B1) | 7.5 | 240 | Each |
| M00558700 | 08714729797586 | 15-16.5-18 | 45-49.5-54 | 5.5 | 3-4.5-7 | 304-456-709 | 2.8 / 3.2* / 3.7 / 4.2 (B2) | 7.5 | 240 | Each |
| M00558710** | 08714729797593 | 18-19-20 | 54-57-60 | 5.5 | 3-4.5-6 | 304-456-608 | 2.8 / 3.2* / 3.7 / 4.2 (B2) | 7.5 | 240 | Each |

Recommended Inflation Device: Alliance™ II Integrated Inflation System Handle Order #5062, Sterile Syringe Order #5060,

[\(Click here to view page 58\).](#)

Guidewire included and preloaded in balloon catheter.

*Requires a 2.8mm Olympus™ Brand Endoscope channel or a 3.2mm Pentax™ or Fujinon™ Brand Endoscope channel.

**Esophageal, Colonic and Biliary application only.

(B1) = Indication requires ≥ 3.2mm Duodenoscope channel.

(B2) = Indication requires ≥ 4.2mm Duodenoscope channel.



Dilation

MaxForce TTS™ Esophageal High Performance Balloon Dilatation Catheter

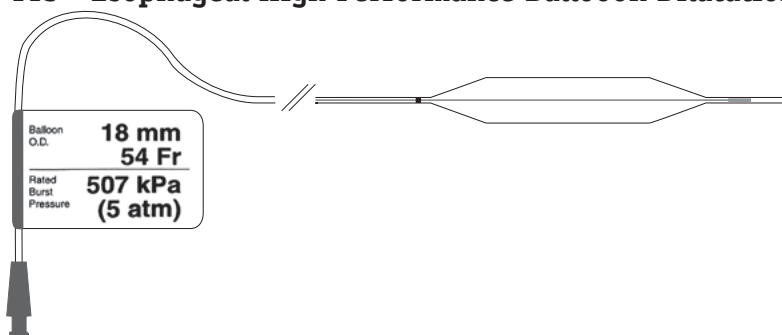

MaxForce TTS Esophageal High Performance Balloon Dilatation Catheter



| Order Number | GTIN | Balloon Inflated O.D. | | Balloon Length (cm) | Inflation Pressures | | Minimum Working Channel (mm) | Catheter Size | | Working Length (cm) | Packaging |
|--------------|----------------|-----------------------|------|---------------------|---------------------|-------|------------------------------|---------------|------|---------------------|-----------|
| | | (mm) | (Fr) | | (ATM) | (kPa) | | (mm) | (Fr) | | |
| M00589060 | 08714729099581 | 6 | 18 | 6 | 10 | 1013 | 2.8 | 2.0 | 6 | 180 | Each |
| M00589080 | 08714729099598 | 8 | 24 | 6 | 10 | 1013 | 2.8 | 2.0 | 6 | 180 | Each |
| M00589100 | 08714729099895 | 10 | 30 | 6 | 7 | 709 | 2.8 | 2.0 | 6 | 180 | Each |
| M00589120 | 08714729099901 | 12 | 36 | 6 | 7 | 709 | 2.8 | 2.0 | 6 | 180 | Each |
| M00589140 | 08714729080602 | 14 | 42 | 6 | 7 | 709 | 2.8 | 2.0 | 6 | 180 | Each |
| M00589150 | 08714729099918 | 15 | 45 | 6 | 5 | 507 | 2.8 | 2.0 | 6 | 180 | Each |
| M00589160 | 08714729080619 | 16 | 48 | 6 | 5 | 507 | 2.8 | 2.0 | 6 | 180 | Each |
| M00589180 | 08714729099925 | 18 | 54 | 6 | 5 | 507 | 2.8 | 2.0 | 6 | 180 | Each |

Recommended Inflation Device: Alliance™ II Integrated Inflation System Handle Order #5062, Sterile Syringe Order #5060,

[\(Click here to view page 58\).](#)

Rigiflex™ II Single-Use Achalasia Balloon Dilators

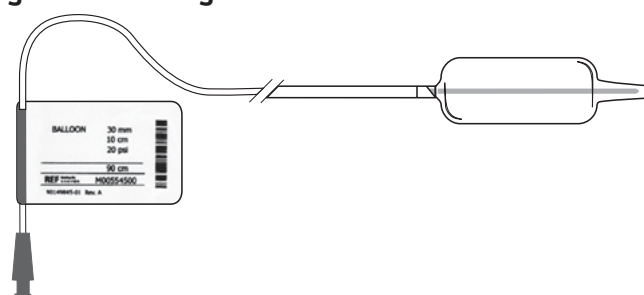

Rigiflex II Single-Use Achalasia Balloon Dilators*



| Order Number | GTIN | Balloon Inflated O.D. | | Balloon Length (cm) | Inflation Pressures | | Working Length (cm) | Catheter Size | | Recommended Guidewire** (in) | Packaging |
|--------------|----------------|-----------------------|------|---------------------|---------------------|-------|---------------------|---------------|------|------------------------------|-----------|
| | | (mm) | (Fr) | | (psi) | (kPa) | | (mm) | (Fr) | | |
| M00554500 | 08714729719106 | 30 | 90 | 10 | 20 | 138 | 90 | 4.6 | 14 | .038 | Each |
| M00554510 | 08714729719113 | 35 | 105 | 10 | 20 | 138 | 90 | 4.6 | 14 | .038 | Each |
| M00554520 | 08714729719120 | 40 | 120 | 10 | 20 | 138 | 90 | 4.6 | 14 | .038 | Each |

*Product Shipped Sterile. Recommended use with Achalasia Pneumatic Hand Pump and Monitor Order #5320,

[\(Click here to view page 58\).](#)

**Guidewire included with Rigiflex II Balloon Dilatation Catheter.



Section Table of Contents

Prev Page **57** Next Page

Main Table of Contents



Dilation

Inflation Systems

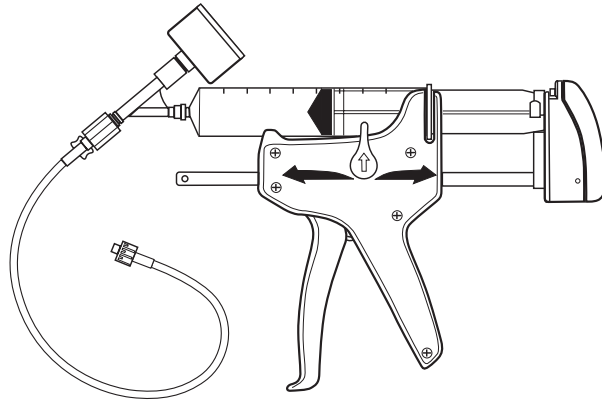

Alliance™ II Inflation System

| Order Number | GTIN | Description | Packaging |
|--------------|----------------|---------------------------------------|-----------|
| M00550620 | 08714729283881 | Inflation Handle | Each |
| M00550601 | 08714729129332 | ⊗ Single-Use Syringe / Gauge Assembly | Box 5 |

Dilation Accessories

Inflation / Deflation Devices and Accessories

| Order Number | GTIN | Description | Packaging |
|--------------|----------------|---|-----------|
| M00553200 | 08714729195450 | Achalasia Pneumatic Hand Pump and Monitor (not shown) | Each |



Dilation

CRE™ Balloon Dilators

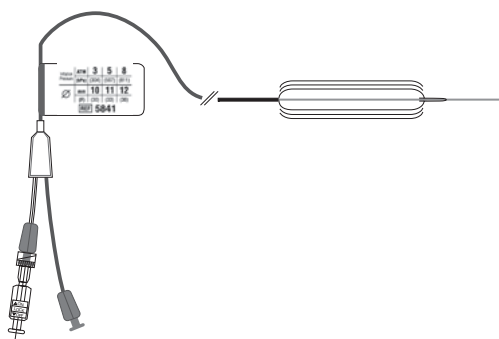

CRE Single-Use Wireguided Esophageal / Pyloric Balloon Dilators



| Order Number | GTIN | Balloon Inflated O.D. | | Balloon Length (cm) | Inflation Pressures | | Minimum Working Channel (mm) | Catheter Size (Fr) | Working Length (cm) | Packaging |
|--------------|----------------|-----------------------|------------|---------------------|---------------------|--------------|------------------------------|--------------------|---------------------|-----------|
| | | (mm) | (Fr) | | (ATM) | (kPa) | | | | |
| M00558390 | 08714729339328 | 6-7-8 | 18-21-24 | 5.5 | 3-6-10 | 304-608-1013 | 2.8 | 7.5 | 180 | Each |
| M00558400 | 08714729339335 | 8-9-10 | 24-27-30 | 5.5 | 3-5.5-9 | 304-557-912 | 2.8 | 7.5 | 180 | Each |
| M00558410 | 08714729339342 | 10-11-12 | 30-33-36 | 5.5 | 3-5-8 | 304-507-811 | 2.8 | 7.5 | 180 | Each |
| M00558420 | 08714729339359 | 12-13.5-15 | 36-40.5-45 | 5.5 | 3-4.5-8 | 304-456-811 | 2.8 | 7.5 | 180 | Each |
| M00558430 | 08714729339366 | 15-16.5-18 | 45-49.5-54 | 5.5 | 3-4.5-7 | 304-456-709 | 2.8 / 3.2* | 7.5 | 180 | Each |
| M00558440** | 08714729339373 | 18-19-20 | 54-57-60 | 5.5 | 3-4.5-6 | 304-456-608 | 2.8 / 3.2* | 7.5 | 180 | Each |

Recommended Inflation Device: Alliance™ II Integrated Inflation System Handle Order #5062, Sterile Syringe Order #5060,

[\(Click here to view page 58\).](#)

Guidewire included and preloaded in balloon catheter.

*Requires a 2.8mm Olympus™ Brand Endoscope channel or a 3.2mm Pentax™ or Fujinon™ Brand Endoscope channel.

**Esophageal application only.

CRE Single-Use Wireguided Esophageal / Pyloric / Colonic Balloon Dilators



| Order Number | GTIN | Balloon Inflated O.D. | | Balloon Length (cm) | Inflation Pressures | | Minimum Working Channel (mm) | Catheter Size (Fr) | Working Length (cm) | Packaging |
|--------------|----------------|-----------------------|------------|---------------------|---------------------|--------------|------------------------------|--------------------|---------------------|-----------|
| | | (mm) | (Fr) | | (ATM) | (kPa) | | | | |
| M00558450 | 08714729339380 | 6-7-8 | 18-21-24 | 5.5 | 3-6-10 | 304-608-1013 | 2.8 / 3.2* | 7.5 | 240 | Each |
| M00558460 | 08714729339397 | 8-9-10 | 24-27-30 | 5.5 | 3-5.5-9 | 304-557-912 | 2.8 / 3.2* | 7.5 | 240 | Each |
| M00558470 | 08714729339403 | 10-11-12 | 30-33-36 | 5.5 | 3-5-8 | 304-507-811 | 2.8 / 3.2* | 7.5 | 240 | Each |
| M00558480 | 08714729339410 | 12-13.5-15 | 36-40.5-45 | 5.5 | 3-4.5-8 | 304-456-811 | 2.8 / 3.2* | 7.5 | 240 | Each |
| M00558490 | 08714729339427 | 15-16.5-18 | 45-49.5-54 | 5.5 | 3-4.5-7 | 304-456-709 | 2.8 / 3.2* | 7.5 | 240 | Each |
| M00558500** | 08714729339434 | 18-19-20 | 54-57-60 | 5.5 | 3-4.5-6 | 304-456-608 | 2.8 / 3.2* | 7.5 | 240 | Each |

Recommended Inflation Device: Alliance II Integrated Inflation System Handle Order #5062, Sterile Syringe Order #5060,

[\(Click here to view page 58\).](#)

Guidewire included and preloaded in balloon catheter.

*Requires a 2.8mm Olympus Brand Endoscope channel or a 3.2mm Pentax or Fujinon Brand Endoscope channel.

**Esophageal or Colonic application only.



Notes and Future Product Updates

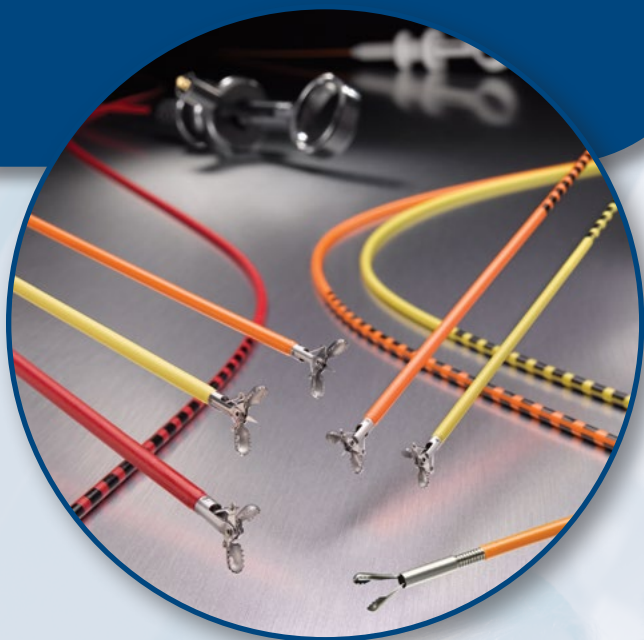

Biopsy

Forceps

- Multibite™ Single-Use Multiple Sample Biopsy Forceps.....63
- Radial Jaw™ 4 Single-Use Hot Biopsy Forceps.....62
- Radial Jaw 4 Single-Use Jumbo Biopsy Forceps.....61
- Radial Jaw 4 Single-Use Large Capacity Biopsy Forceps61
- Radial Jaw 4 Single-Use Pediatric Biopsy Forceps62
- Radial Jaw 4 Standard Capacity Single-Use Biopsy Forceps.....61



Biopsy

Forceps

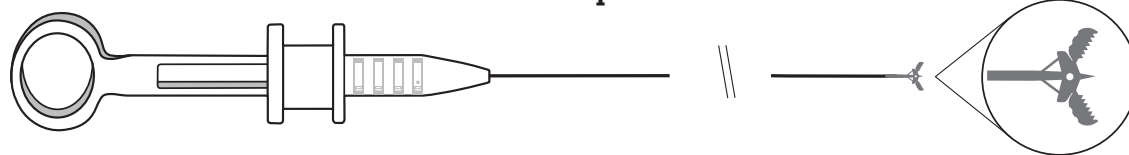

Radial Jaw™ 4 Single-Use Jumbo Biopsy Forceps



| Order Number | GTIN | Description | Jaw O.D. (mm) | Working Length (cm) | Minimum Working Channel (mm) | Color Code | Packaging |
|--------------|----------------|--------------------------------------|---------------|---------------------|------------------------------|------------|-----------|
| M00513343 | 08714729761891 | Radial Jaw 4 Jumbo Forceps | 2.8 | 160 | 3.2 | Yellow | Box 5 |
| M00513353 | 08714729761907 | Radial Jaw 4 Jumbo Forceps w/ Needle | 2.8 | 160 | 3.2 | Yellow | Box 5 |
| M00513363 | 08714729761914 | Radial Jaw 4 Jumbo Forceps | 2.8 | 240 | 3.2 | Orange | Box 5 |
| M00513373 | 08714729761938 | Radial Jaw 4 Jumbo Forceps w/ Needle | 2.8 | 240 | 3.2 | Orange | Box 5 |
| M00513361 | 08714729648871 | Radial Jaw 4 Jumbo Forceps | 2.8 | 240 | 3.2 | Orange | Box 20 |
| M00513371 | 08714729648895 | Radial Jaw 4 Jumbo Forceps w/ Needle | 2.8 | 240 | 3.2 | Orange | Box 20 |
| M00513362 | 08714729648888 | Radial Jaw 4 Jumbo Forceps | 2.8 | 240 | 3.2 | Orange | Box 40 |
| M00513372 | 08714729648901 | Radial Jaw 4 Jumbo Forceps w/ Needle | 2.8 | 240 | 3.2 | Orange | Box 40 |

Radial Jaw 4 Single-Use Large Capacity Biopsy Forceps



| Order Number | GTIN | Description | Jaw O.D. (mm) | Working Length (cm) | Minimum Working Channel (mm) | Color Code | Packaging |
|--------------|----------------|---|---------------|---------------------|------------------------------|------------|-----------|
| M00513303 | 08714729761839 | Radial Jaw 4 Large Capacity Forceps | 2.4 | 160 | 2.8 | Yellow | Box 5 |
| M00513313 | 08714729761853 | Radial Jaw 4 Large Capacity Forceps w/ Needle | 2.4 | 160 | 2.8 | Yellow | Box 5 |
| M00513323 | 08714729761877 | Radial Jaw 4 Large Capacity Forceps | 2.4 | 240 | 2.8 | Orange | Box 5 |
| M00513333 | 08714729755494 | Radial Jaw 4 Large Capacity Forceps w/ Needle | 2.4 | 240 | 2.8 | Orange | Box 5 |
| M00513301 | 08714729648758 | Radial Jaw 4 Large Capacity Forceps | 2.4 | 160 | 2.8 | Yellow | Box 20 |
| M00513311 | 08714729648772 | Radial Jaw 4 Large Capacity Forceps w/ Needle | 2.4 | 160 | 2.8 | Yellow | Box 20 |
| M00513321 | 08714729648796 | Radial Jaw 4 Large Capacity Forceps | 2.4 | 240 | 2.8 | Orange | Box 20 |
| M00513331 | 08714729648819 | Radial Jaw 4 Large Capacity Forceps w/ Needle | 2.4 | 240 | 2.8 | Orange | Box 20 |
| M00513302 | 08714729648765 | Radial Jaw 4 Large Capacity Forceps | 2.4 | 160 | 2.8 | Yellow | Box 40 |
| M00513312 | 08714729648789 | Radial Jaw 4 Large Capacity Forceps w/ Needle | 2.4 | 160 | 2.8 | Yellow | Box 40 |
| M00513322 | 08714729648802 | Radial Jaw 4 Large Capacity Forceps | 2.4 | 240 | 2.8 | Orange | Box 40 |
| M00513332 | 08714729648826 | Radial Jaw 4 Large Capacity Forceps w/ Needle | 2.4 | 240 | 2.8 | Orange | Box 40 |

Radial Jaw 4 Standard Capacity Single-Use Biopsy Forceps



| Order Number | GTIN | Description | Jaw O.D. (mm) | Working Length (cm) | Minimum Working Channel (mm) | Color Code | Packaging |
|--------------|----------------|--|---------------|---------------------|------------------------------|------------|-----------|
| M00513383 | 08714729777915 | Radial Jaw 4 Standard Capacity Forceps | 2.2 | 160 | 2.8 | Yellow | Box 5 |
| M00513393 | 08714729777939 | Radial Jaw 4 Standard Capacity Forceps w/ Needle | 2.2 | 160 | 2.8 | Yellow | Box 5 |
| M00513403 | 08714729777922 | Radial Jaw 4 Standard Capacity Forceps | 2.2 | 240 | 2.8 | Orange | Box 5 |
| M00513413 | 08714729777946 | Radial Jaw 4 Standard Capacity Forceps w/ Needle | 2.2 | 240 | 2.8 | Orange | Box 5 |
| M00513381 | 08714729777953 | Radial Jaw 4 Standard Capacity Forceps | 2.2 | 160 | 2.8 | Yellow | Box 20 |
| M00513391 | 08714729777977 | Radial Jaw 4 Standard Capacity Forceps w/ Needle | 2.2 | 160 | 2.8 | Yellow | Box 20 |
| M00513401 | 08714729777960 | Radial Jaw 4 Standard Capacity Forceps | 2.2 | 240 | 2.8 | Orange | Box 20 |
| M00513411 | 08714729777984 | Radial Jaw 4 Standard Capacity Forceps w/ Needle | 2.2 | 240 | 2.8 | Orange | Box 20 |
| M00513382 | 08714729778011 | Radial Jaw 4 Standard Capacity Forceps | 2.2 | 160 | 2.8 | Yellow | Box 40 |
| M00513392 | 08714729777991 | Radial Jaw 4 Standard Capacity Forceps w/ Needle | 2.2 | 160 | 2.8 | Yellow | Box 40 |
| M00513402 | 08714729778028 | Radial Jaw 4 Standard Capacity Forceps | 2.2 | 240 | 2.8 | Orange | Box 40 |
| M00513412 | 08714729778004 | Radial Jaw 4 Standard Capacity Forceps w/ Needle | 2.2 | 240 | 2.8 | Orange | Box 40 |



Biopsy

Forceps (Continued)

Radial Jaw™ 4 Single-Use Pediatric Biopsy Forceps



| Order Number | GTIN | Description | Jaw O.D. (mm) | Working Length (cm) | Minimum Working Channel (mm) | Packaging |
|--------------|----------------|---|---------------|---------------------|------------------------------|-----------|
| M00513443 | 08714729790211 | Radial Jaw 4 Pediatric Biopsy Forceps | 1.8 | 160 | ≥ 2.0 | Box 5 |
| M00513453 | 08714729790228 | Radial Jaw 4 Pediatric Biopsy Forceps w/ Needle | 1.8 | 160 | ≥ 2.0 | Box 5 |

Hot Biopsy Forceps



Radial Jaw 4 Single-Use Hot Biopsy Forceps



| Order Number | GTIN | Description | Jaw O.D. (mm) | Working Length (cm) | Minimum Working Channel (mm) | Packaging |
|--------------|----------------|---------------------------------|---------------|---------------------|------------------------------|-----------|
| M00515031 | 08714729790136 | Radial Jaw 4 Hot Biopsy Forceps | 2.2 | 240 | ≥ 2.8 | Box 5 |
| M00515032 | 08714729790105 | Radial Jaw 4 Hot Biopsy Forceps | 2.2 | 240 | ≥ 2.8 | Box 20 |
| M00515033 | 08714729790143 | Radial Jaw 4 Hot Biopsy Forceps | 2.2 | 240 | ≥ 2.8 | Box 40 |



Biopsy

Forceps (Continued)

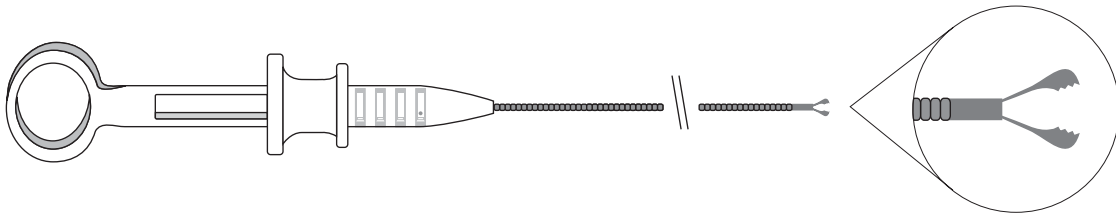

Multibite™ Single-Use Multiple Sample Biopsy Forceps



| Order Number | GTIN | Description | Jaw O.D. (mm) | Working Length (cm) | Minimum Working Channel (mm) | Color Code | Packaging |
|--------------|----------------|--|---------------|---------------------|------------------------------|------------|-----------|
| M00510101 | 08714729164975 | Multibite Multiple Sample Biopsy Forceps | 2.4 | 160 | 2.8 | Yellow | Box 5 |
| M00510121 | 08714729164982 | Multibite Multiple Sample Biopsy Forceps | 2.4 | 240 | 2.8 | Orange | Box 5 |

Notes and Future Product Updates



EndoVive™ Enteral Access Devices

Percutaneous Endoscopic Gastrostomy (PEG) Devices – Initial Placement Gastrostomy Devices

| | |
|--|----|
| ➤ Safety PEGs..... | 65 |
| ➤ Standard PEGs | 65 |
| ➤ Initial Placement PEG Accessories..... | 65 |

One-Step Button™ Low Profile PEG Kits

| | |
|--|----|
| ➤ One-Step Button Low Profile PEG Kits | 66 |
| ➤ One-Step Button and Low Profile Button Accessories | 66 |

Jejunal Feeding Tube Devices

| | |
|--|----|
| ➤ Through-the-PEG (TTP) Jejunal Feeding Tube (3-port)..... | 67 |
|--|----|

Gastrostomy Tubes

| | |
|---|----|
| ➤ Standard Balloon Replacements: Straight..... | 67 |
| ➤ Standard Balloon Replacements: Right-Angle..... | 67 |

Accessories & Replacements

| | |
|--|----|
| ➤ Low Profile Button..... | 68 |
| ➤ One-Step Button and Low Profile Button Accessories | 68 |



EndoVive™ Enteral Access Devices

Percutaneous Endoscopic Gastrostomy (PEG) Devices

Initial Placement Gastrostomy Devices

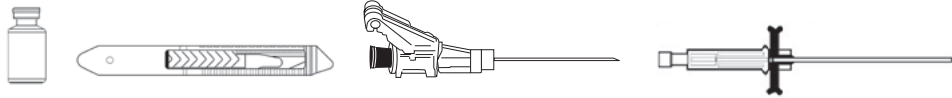

Safety PEGs*



| Order Number | GTIN | Description | Packaging |
|--------------|----------------|---------------------------|-----------|
| M00566461 | 08714729802624 | 20Fr Safety PEG Kit, Pull | Box 2 |
| M00566471 | 08714729802631 | 20Fr Safety PEG Kit, Push | Box 2 |
| M00566481 | 08714729802648 | 24Fr Safety PEG Kit, Pull | Box 2 |
| M00566491 | 08714729802655 | 24Fr Safety PEG Kit, Push | Box 2 |

*Includes local anesthetic.



Standard PEGs*



| Order Number | GTIN | Description | Packaging |
|--------------|----------------|-----------------------------|-----------|
| M00568201 | 08714729285199 | 20Fr Standard PEG Kit, Pull | Box 2 |
| M00568211 | 08714729285205 | 20Fr Standard PEG Kit, Push | Box 2 |
| M00568241 | 08714729296799 | 24Fr Standard PEG Kit, Pull | Box 2 |
| M00568251 | 08714729296805 | 24Fr Standard PEG Kit, Push | Box 2 |

*Includes local anesthetic.

Initial Placement PEG Accessories



| Order Number | GTIN | Description | Packaging |
|--------------|----------------|----------------------|-----------|
| M00580641 | 08714729169116 | 20Fr Y-Ports | Box 10 |
| M00580651 | 08714729169123 | 24Fr Y-Ports | Box 10 |
| M00580731 | 08714729415343 | 20Fr Round Bolsters | Box 10 |
| M00580781 | 08714729415398 | 20Fr / 24Fr C Clamps | Box 10 |



EndoVive™ Enteral Access Devices

Percutaneous Endoscopic Gastrostomy (PEG) Devices

One-Step Button™ Low Profile PEG Kits

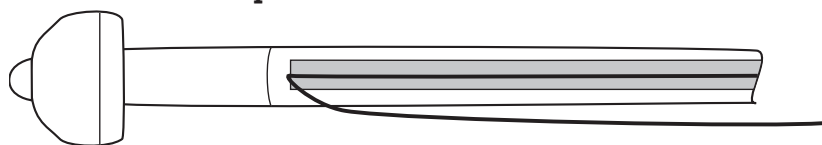

| One-Step Button Low Profile PEG Kits | | | | |
|--------------------------------------|----------------|--------------------------------|-------------|-----------|
| Order Number | GTIN | Description | Length (cm) | Packaging |
| M00563120 | 08714729284246 | 18Fr Low Profile PEG Kit, Pull | 1.2 | Each |
| M00563130 | 08714729284253 | 18Fr Low Profile PEG Kit, Pull | 1.7 | Each |
| M00563140 | 08714729284260 | 18Fr Low Profile PEG Kit, Pull | 2.4 | Each |
| M00563150 | 08714729284277 | 18Fr Low Profile PEG Kit, Pull | 3.4 | Each |
| M00563160 | 08714729284284 | 18Fr Low Profile PEG Kit, Pull | 4.4 | Each |
| M00563180 | 08714729284307 | 18Fr Low Profile PEG Kit, Push | 1.7 | Each |
| M00563190 | 08714729284314 | 18Fr Low Profile PEG Kit, Push | 2.4 | Each |
| M00563010 | 08714729284147 | 24Fr Low Profile PEG Kit, Pull | 1.7 | Each |
| M00563020 | 08714729284154 | 24Fr Low Profile PEG Kit, Pull | 2.4 | Each |
| M00563030 | 08714729284161 | 24Fr Low Profile PEG Kit, Pull | 3.4 | Each |
| M00563040 | 08714729268833 | 24Fr Low Profile PEG Kit, Pull | 4.4 | Each |
| M00563080 | 08714729284208 | 24Fr Low Profile PEG Kit, Push | 2.4 | Each |
| M00563090 | 08714729284215 | 24Fr Low Profile PEG Kit, Push | 3.4 | Each |
| M00563100 | 08714729284222 | 24Fr Low Profile PEG Kit, Push | 4.4 | Each |

| One-Step Button and Low Profile Button Accessories | | | | |
|--|----------------|---|-------------|-----------|
| Order Number | GTIN | Description | Length (cm) | Packaging |
| M00580401 | 08714729166443 | 18Fr Decompression Tube | 1.2 | Box 10 |
| M00580411 | 08714729166450 | 18Fr Decompression Tube | 1.7 | Box 10 |
| M00580421 | 08714729166467 | 18Fr Decompression Tube | 2.4 | Box 10 |
| M00580431 | 08714729166474 | 18Fr Decompression Tube | 3.4 | Box 10 |
| M00580441 | 08714729166481 | 18Fr Decompression Tube | 4.4 | Box 10 |
| M00580461 | 08714729166504 | 24Fr Decompression Tube | 1.7 | Box 10 |
| M00580471 | 08714729166511 | 24Fr Decompression Tube | 2.4 | Box 10 |
| M00580481 | 08714729339649 | 24Fr Decompression Tube | 3.4 | Box 10 |
| M00580491 | 08714729166535 | 24Fr Decompression Tube | 4.4 | Box 10 |
| M00580171 | 08714729142232 | 18Fr Bolus Straight Feeding Adapter | – | Box 10 |
| M00580181 | 08714729142249 | 18Fr Continuous Right Angle Feeding Adapter | – | Box 10 |
| M00580231 | 08714729166405 | 24Fr Bolus Straight Feeding Adapter | – | Box 10 |
| M00580241 | 08714729166412 | 24Fr Continuous Right Angle Feeding Adapter | – | Box 10 |

EndoVive™ Enteral Access Devices

Jejunal Feeding Tube Devices

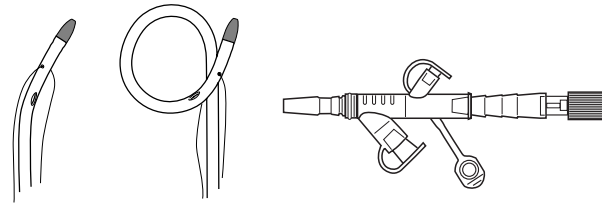

Through-The-PEG (TTP) Jejunal Feeding Tube (3-Port)



| Order Number | GTIN | Description | Tip Style | Packaging |
|--------------|----------------|--------------------------------|-------------|-----------|
| M00566320 | 08714729786313 | 8.5Fr TTP Jejunal Feeding Tube | Bent Tip | Each |
| M00566330 | 08714729789727 | 8.5Fr TTP Jejunal Feeding Tube | Pigtail Tip | Each |
| M00566340 | 08714729789666 | 12Fr TTP Jejunal Feeding Tube | Bent Tip | Each |
| M00566350 | 08714729786252 | 12Fr TTP Jejunal Feeding Tube | Pigtail Tip | Each |

Gastrostomy Tubes

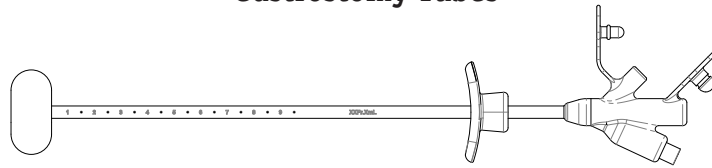

Standard Balloon Replacements: Straight



| Order Number | Description | Packaging |
|--------------|-----------------------------------|-----------|
| M00582040 | 12Fr Replacement G-Tube, Straight | Each |
| M00582050 | 14Fr Replacement G-Tube, Straight | Each |
| M00582060 | 16Fr Replacement G-Tube, Straight | Each |
| M00582070 | 18Fr Replacement G-Tube, Straight | Each |
| M00582080 | 20Fr Replacement G-Tube, Straight | Each |
| M00582860 | 22Fr Replacement G-Tube, Straight | Each |
| M00582090 | 24Fr Replacement G-Tube, Straight | Each |
| M00582100 | 28Fr Replacement G-Tube, Straight | Each |

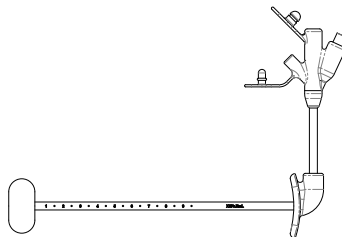

Standard Balloon Replacements: Right-Angle



| Order Number | Description | Packaging |
|--------------|--------------------------------------|-----------|
| M00582110 | 12Fr Replacement G-Tube, Right-Angle | Each |
| M00582120 | 14Fr Replacement G-Tube, Right-Angle | Each |
| M00582130 | 16Fr Replacement G-Tube, Right-Angle | Each |
| M00582140 | 18Fr Replacement G-Tube, Right-Angle | Each |
| M00582150 | 20Fr Replacement G-Tube, Right-Angle | Each |
| M00582870 | 22Fr Replacement G-Tube, Right-Angle | Each |
| M00582160 | 24Fr Replacement G-Tube, Right-Angle | Each |
| M00582170 | 28Fr Replacement G-Tube, Right-Angle | Each |



EndoVive™ Enteral Access Devices

Accessories & Replacements

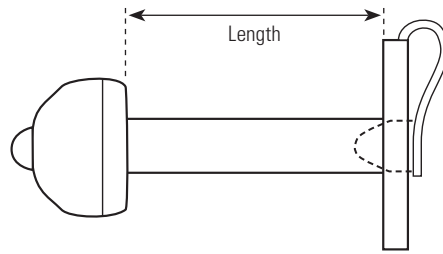

Low Profile Button



| Order Number | GTIN | Description | Length (cm) | Packaging |
|--------------|----------------|-------------------------|-------------|-----------|
| M00562760 | 08714729284017 | 18Fr Low Profile Button | 1.2 | Each |
| M00562770 | 08714729142201 | 18Fr Low Profile Button | 1.7 | Each |
| M00562780 | 08714729284024 | 18Fr Low Profile Button | 2.4 | Each |
| M00562790 | 08714729284031 | 18Fr Low Profile Button | 3.4 | Each |
| M00562800 | 08714729284048 | 18Fr Low Profile Button | 4.4 | Each |
| M00562820 | 08714729284062 | 24Fr Low Profile Button | 1.7 | Each |
| M00562830 | 08714729142218 | 24Fr Low Profile Button | 2.4 | Each |
| M00562840 | 08714729284079 | 24Fr Low Profile Button | 3.4 | Each |
| M00562850 | 08714729284086 | 24Fr Low Profile Button | 4.4 | Each |

One-Step Button™ and Low Profile Button Accessories



| Order Number | GTIN | Description | Length (cm) | Packaging |
|--------------|----------------|---|-------------|-----------|
| M00580401 | 08714729166443 | 18Fr Decompression Tube | 1.2 | Box 10 |
| M00580411 | 08714729166450 | 18Fr Decompression Tube | 1.7 | Box 10 |
| M00580421 | 08714729166467 | 18Fr Decompression Tube | 2.4 | Box 10 |
| M00580431 | 08714729166474 | 18Fr Decompression Tube | 3.4 | Box 10 |
| M00580441 | 08714729166481 | 18Fr Decompression Tube | 4.4 | Box 10 |
| M00580461 | 08714729166504 | 24Fr Decompression Tube | 1.7 | Box 10 |
| M00580471 | 08714729166511 | 24Fr Decompression Tube | 2.4 | Box 10 |
| M00580481 | 08714729339649 | 24Fr Decompression Tube | 3.4 | Box 10 |
| M00580491 | 08714729166535 | 24Fr Decompression Tube | 4.4 | Box 10 |
| M00580171 | 08714729142232 | 18Fr Bolus Straight Feeding Adapter | – | Box 10 |
| M00580181 | 08714729142249 | 18Fr Continuous Right Angle Feeding Adapter | – | Box 10 |
| M00580231 | 08714729166405 | 24Fr Bolus Straight Feeding Adapter | – | Box 10 |
| M00580241 | 08714729166412 | 24Fr Continuous Right Angle Feeding Adapter | – | Box 10 |



Notes and Future Product Updates

Notes and Future Product Updates



Tissue Resection

Snares

- Captiflex™ Single-Use Snares72
- Captivator™ Single-Use Snares72
- Captivator II Single-Use Snare73
- Profile™ Single-Use Snares74
- Sensation™ Single-Use Short Throw Snares.....71
- Single-Use Rotatable Snares71

Active Cords

- Active Cords.....74

Retrieval Device

- TWISTER® PLUS Rotatable Retrieval Device.....74

Tissue Resection

Snares

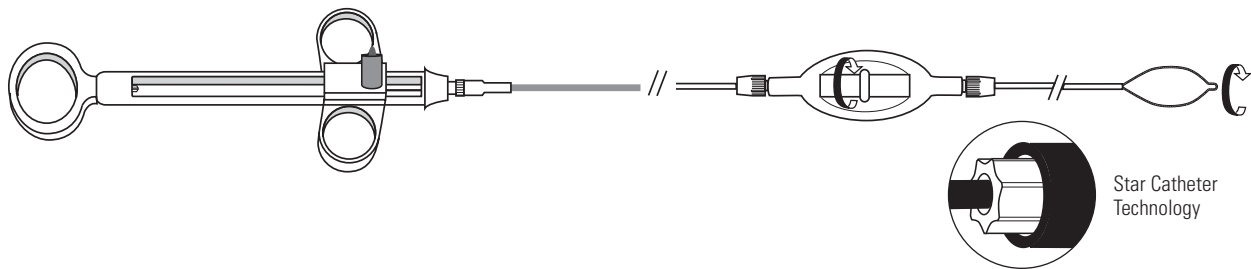

Single-Use Rotatable Snares*



| Order Number | GTIN | Description | Loop Width (mm) | Sheath O.D. (mm) | Minimum Working Channel (mm) | Working Length (cm) | Packaging |
|--------------|----------------|----------------------------|-----------------|------------------|------------------------------|---------------------|-----------|
| M00561821 | 08714729283980 | Small Oval – Medium Stiff | 13 | 2.4 | 2.8 | 195 | Box 10 |
| M00561831 | 08714729283997 | Medium Oval – Medium Stiff | 20 | 2.4 | 2.8 | 195 | Box 10 |

*With Star Catheter™ Technology.

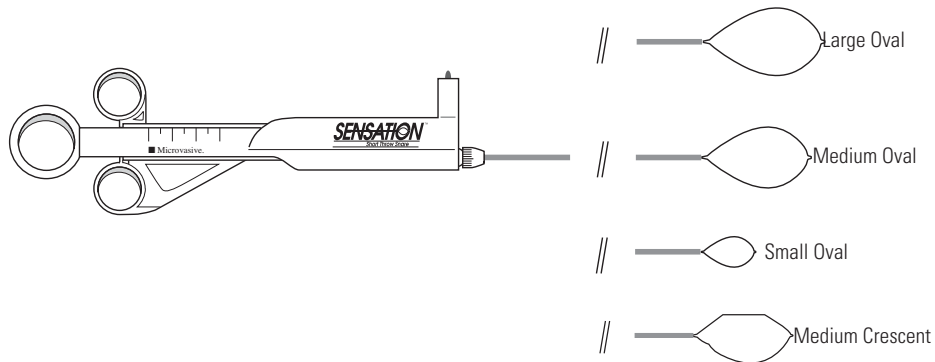

Sensation™ Single-Use Short Throw Snares



| Order Number | GTIN | Description | Loop Width (mm) | Sheath O.D. (mm) | Minimum Working Channel (mm) | Working Length (cm) | Packaging |
|--------------|----------------|--------------------------------|-----------------|------------------|------------------------------|---------------------|-----------|
| M00562691 | 08714729158158 | Small Oval – Flexible | 13 | 2.4 | 2.8 | 240 | Box 5 |
| M00562692 | 08714729268826 | Small Oval – Flexible | 13 | 2.4 | 2.8 | 240 | Box 20 |
| M00562693 | 08714729501671 | Small Oval – Flexible | 13 | 2.4 | 2.8 | 240 | Box 40 |
| M00560321 | 08714729283928 | Small Oval – Medium Stiff | 13 | 2.4 | 2.8 | 240 | Box 5 |
| M00562671 | 08714729158141 | Medium Oval – Flexible | 27 | 2.4 | 2.8 | 240 | Box 5 |
| M00562672 | 08714729268819 | Medium Oval – Flexible | 27 | 2.4 | 2.8 | 240 | Box 20 |
| M00562673 | 08714729501664 | Medium Oval – Flexible | 27 | 2.4 | 2.8 | 240 | Box 40 |
| M00560311 | 08714729283904 | Medium Oval – Medium Stiff | 27 | 2.4 | 2.8 | 240 | Box 5 |
| M00562651 | 08714729158110 | Large Oval – Medium Stiff | 30 | 2.4 | 2.8 | 240 | Box 5 |
| M00562652 | 08714729268802 | Large Oval – Medium Stiff | 30 | 2.4 | 2.8 | 240 | Box 20 |
| M00560331 | 08714729283935 | Medium Crescent – Medium Stiff | 27 | 2.4 | 2.8 | 240 | Box 5 |

Tissue Resection

Snares (Continued)

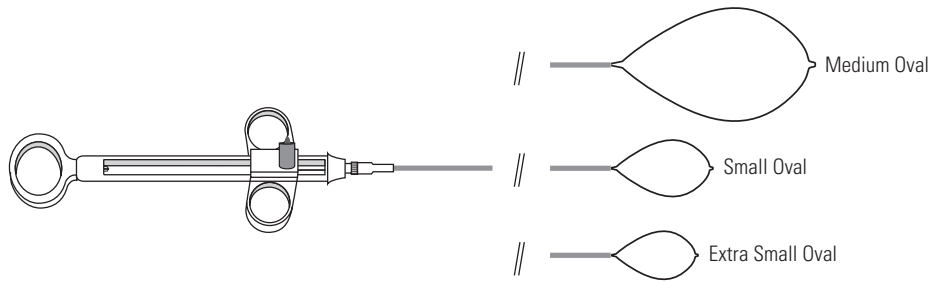

Captiflex™ Single-Use Snares



| Order Number | GTIN | Description | Loop Width (mm) | Sheath O.D. (mm) | Minimum Working Channel (mm) | Working Length (cm) | Packaging |
|--------------|----------------|-----------------------------|-----------------|------------------|------------------------------|---------------------|-----------|
| M00562471 | 08714729019459 | Extra Small Oval – Flexible | 11 | 2.4 | 2.8 | 240 | Box 10 |
| M00562421 | 08714729019435 | Small Oval – Flexible | 13 | 2.4 | 2.8 | 240 | Box 10 |
| M00562422 | 08714729501657 | Small Oval – Flexible | 13 | 2.4 | 2.8 | 240 | Box 40 |
| M00562401 | 08714729019411 | Medium Oval – Flexible | 27 | 2.4 | 2.8 | 240 | Box 10 |
| M00562402 | 08714729501640 | Medium Oval – Flexible | 27 | 2.4 | 2.8 | 240 | Box 40 |

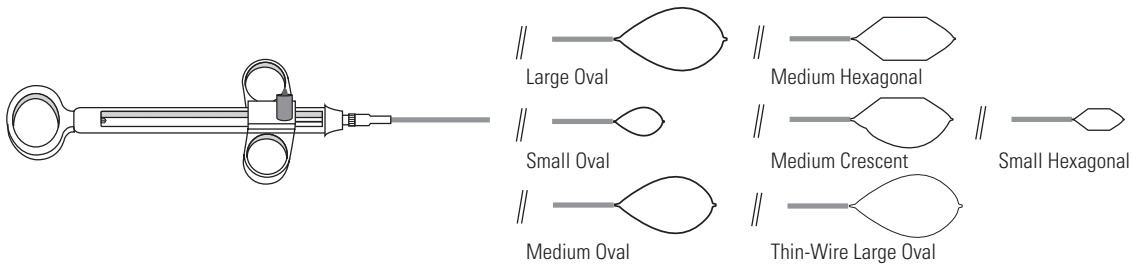

Captivator™ Single-Use Snares



| Order Number | GTIN | Description | Loop Width (mm) | Sheath O.D. (mm) | Minimum Working Channel (mm) | Working Length (cm) | Packaging |
|--------------|----------------|-----------------------------------|-----------------|------------------|------------------------------|---------------------|-----------|
| M00562301 | 08714729019312 | Small Oval – Stiff | 13 | 2.4 | 2.8 | 240 | Box 10 |
| M00562321 | 08714729019312 | Medium Oval – Stiff | 27 | 2.4 | 2.8 | 240 | Box 10 |
| M00561311 | 08714729019251 | Large Oval – Medium Stiff | 30 | 2.4 | 2.8 | 240 | Box 10 |
| M00562391 | 08714729019404 | Large Oval (thin wire) – Flexible | 30 | 2.4 | 2.8 | 240 | Box 10 |
| M00562451 | 08714729071068 | Small Hexagonal – Stiff | 13 | 2.4 | 2.8 | 240 | Box 10 |
| M00562341 | 08714729019350 | Medium Hexagonal – Stiff | 27 | 2.4 | 2.8 | 240 | Box 10 |
| M00562371 | 08714729019381 | Medium Crescent – Stiff | 27 | 2.4 | 2.8 | 240 | Box 10 |



Tissue Resection

Snare (Continued)

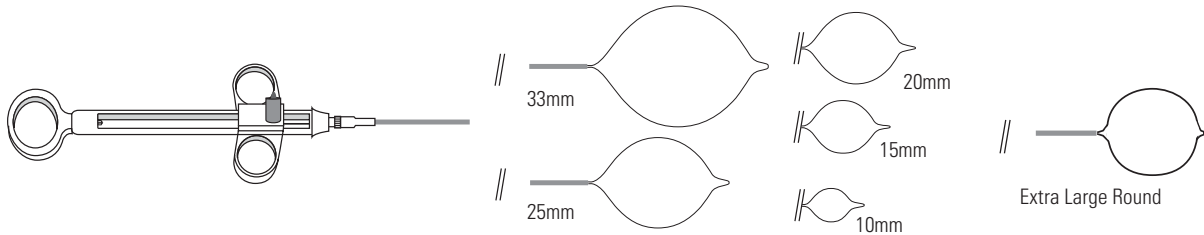

Captivator™ II Single-Use Snare



| Order Number | GTIN | Description | Loop Width (mm) | Sheath O.D. (mm) | Minimum Working Channel (mm) | Working Length (cm) | Quantity |
|--------------|----------------|-----------------------------|-----------------|------------------|------------------------------|---------------------|----------|
| M00561221 | 08714729855903 | 10mm Rounded – Stiff | 10 | 2.4 | 2.8 | 240 | Box 10 |
| M00561222 | 08714729861300 | 10mm Rounded – Stiff | 10 | 2.4 | 2.8 | 240 | Box 20 |
| M00561223 | 08714729861317 | 10mm Rounded – Stiff | 10 | 2.4 | 2.8 | 240 | Box 40 |
| M00561231 | 08714729855910 | 15mm Rounded – Stiff | 15 | 2.4 | 2.8 | 240 | Box 10 |
| M00561232 | 08714729861331 | 15mm Rounded – Stiff | 15 | 2.4 | 2.8 | 240 | Box 20 |
| M00561233 | 08714729861348 | 15mm Rounded – Stiff | 15 | 2.4 | 2.8 | 240 | Box 40 |
| M00561241 | 08714729855927 | 20mm Rounded – Stiff | 20 | 2.4 | 2.8 | 240 | Box 10 |
| M00561242 | 08714729861362 | 20mm Rounded – Stiff | 20 | 2.4 | 2.8 | 240 | Box 20 |
| M00561243 | 08714729861379 | 20mm Rounded – Stiff | 20 | 2.4 | 2.8 | 240 | Box 40 |
| M00561191 | 08714729855934 | 25mm Rounded – Stiff | 25 | 2.4 | 2.8 | 240 | Box 10 |
| M00561192 | 08714729861270 | 25mm Rounded – Stiff | 25 | 2.4 | 2.8 | 240 | Box 20 |
| M00561193 | 08714729861287 | 25mm Rounded – Stiff | 25 | 2.4 | 2.8 | 240 | Box 40 |
| M00561291 | 08714729645801 | Extra Large Rounded – Stiff | 33 | 2.4 | 2.8 | 240 | Box 10 |



Tissue Resection

Snares (Continued)

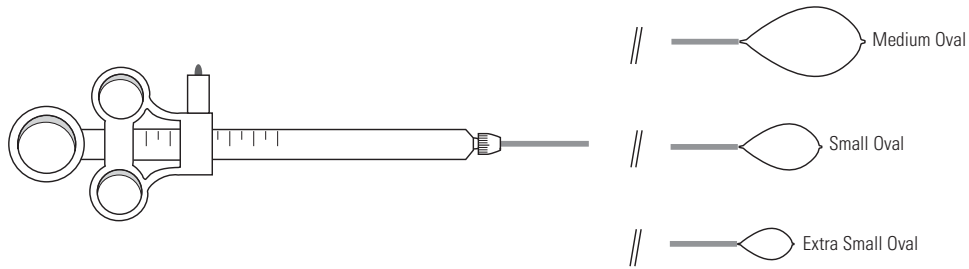

Profile™ Single-Use Snares



| Order Number | GTIN | Description | Loop Width (mm) | Sheath O.D. (mm) | Minimum Working Channel (mm) | Working Length (cm) | Packaging |
|--------------|----------------|-----------------------------|-----------------|------------------|------------------------------|---------------------|-----------|
| M00562531 | 08714729156628 | Extra Small Oval – Flexible | 11 | 1.9 | 2.0 | 240 | Box 10 |
| M00562551 | 08714729156659 | Small Oval – Flexible | 13 | 1.9 | 2.0 | 240 | Box 10 |
| M00562571 | 08714729156635 | Medium Oval – Flexible | 27 | 1.9 | 2.0 | 240 | Box 10 |

Active Cords

Active Cords

| Order Number | GTIN | Description | Packaging |
|--------------|----------------|---|-----------|
| M00561250 | 08714729019060 | Active Cord, Fits Olympus™ Brand Generator | Each |
| M00561270 | 08714729053361 | Active Cord, Fits Endostat™, Endostat II and Endostat III Generators, Bovie™, Valleylab™, Aspen Labs™, and ERBE™ Brand Generators | Each |

Retrieval Device

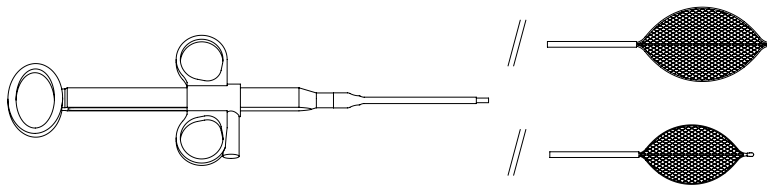

TWISTER® PLUS Rotatable Retrieval Device*



| Order Number | Description | Loop Width (mm) | Sheath OD (mm) | Working Length (cm) | Min. Working Channel (mm) | Packaging |
|--------------|---|-----------------|----------------|---------------------|---------------------------|-----------|
| M00561411 | TWISTER PLUS Rotatable Retrieval Device | 22 | 2.5 | 230 | 2.8 | Box 5 |
| M00561421 | TWISTER PLUS Rotatable Retrieval Device | 26 | 2.5 | 230 | 2.8 | Box 5 |
| M00561412 | TWISTER PLUS Rotatable Retrieval Device | 22 | 2.5 | 230 | 2.8 | Box 10 |
| M00561422 | TWISTER PLUS Rotatable Retrieval Device | 26 | 2.5 | 230 | 2.8 | Box 10 |

Notes and Future Product Updates

Notes and Future Product Updates

Blank lined area for notes and future product updates.



Pulmonary Endoscopy

Alair™ Bronchial Thermoplasty System

- ▶ Alair Bronchial Thermoplasty System77

Airway Stents

- ▶ Dynamic™ (Y) Stent77
- ▶ Polyflex™ Single-Use Self-Expanding Silicone Airway Stent.....80
- ▶ Ultraflex™ Single-Use Partially Covered Tracheobronchial Stent System – Distal Release79
- ▶ Ultraflex Single-Use Uncovered Tracheobronchial Stent System – Distal Release.....78
- ▶ Ultraflex Single-Use Uncovered Tracheobronchial Stent System – Proximal Release.....78

Biopsy Forceps

- ▶ Radial Jaw™ 4 Single-Use Pulmonary Biopsy Forceps.....81

Transbronchial Aspiration Needles

- ▶ eXcelon™ Transbronchial Aspiration Needle.....81

Cytology Brushes

- ▶ Cellebrity™ Single-Use Endoscopic Cytology Brush – Bronchoscope.....82

Airway Retrieval Baskets

- ▶ Zero Tip™ Airway Retrieval Basket.....82

Controlled Radial Expansion Pulmonary Balloon Dilators

- ▶ CRE™ Single-Use Pulmonary Balloon Dilator83

Pulmonary Guidewires

- ▶ Pulmonary Jagwire™ Pulmonary Guidewire.....83

Inflation System

- ▶ Alliance™ II Inflation System.....83



Pulmonary

Alair™ Bronchial Thermoplasty System

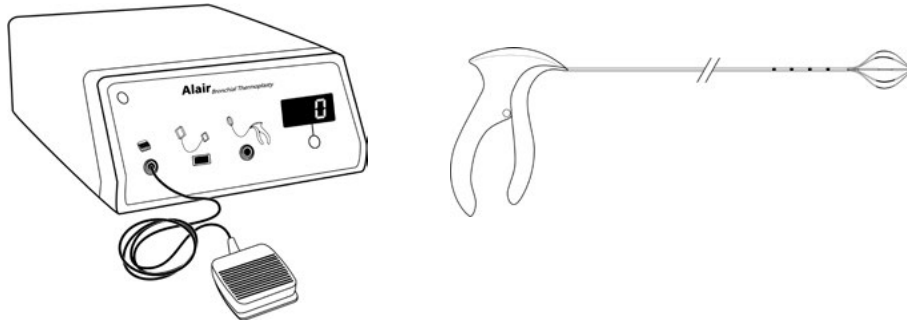

Alair Bronchial Thermoplasty System*

| Order Number | GTIN | Model Number | Description | Packaging |
|----------------------|----------------|---------------|---|-----------|
| M005 ATS20000 | 08714729796695 | Alair ATS 200 | Alair Bronchial Thermoplasty Controller | Each |
| M005 ATS25010 | 08714729802792 | Alair ATS 2-5 | ⊗ Alair Bronchial Thermoplasty Catheter** | Each |
| M005 ATS20110 | 08714729802778 | Alair ATS 201 | Alair RF Controller Accessory Kit | Each |

*Service Agreement available with 1, 2, 3, and 4 year terms.

****Note:** Initial stocking order requires a minimum order of 6 catheters (covering the complete treatment of 2 patients).

| UPN | Description |
|------------------------|-------------------------------|
| SRVM005 ATS1001 | ENDO POS 1 Year Service Alair |
| SRVM005 ATS1002 | ENDO POS 2 Year Service Alair |
| SRVM005 ATS1003 | ENDO POS 3 Year Service Alair |
| SRVM005 ATS1004 | ENDO POS 4 Year Service Alair |

Airway Stents

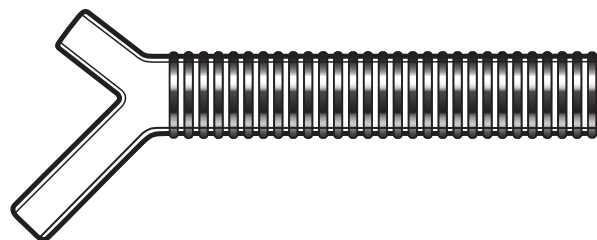

Dynamic™ (Y) Stent



| Order Number | GTIN | Tracheal Width (I) (mm) | Bronchial Width (I) (mm) | Tracheal Length (mm) | Bronchial Lengths (R / L) (mm) | Packaging |
|-------------------|----------------|-------------------------|--------------------------|----------------------|--------------------------------|-----------|
| M005 70670 | 08714729764809 | 11 | 8 | 110 | 25 / 40 | Each |
| M005 70680 | 08714729764816 | 13 | 10 | 110 | 25 / 40 | Each |
| M005 70690 | 08714729764823 | 15 | 12 | 110 | 25 / 40 | Each |



Pulmonary

Airway Stents (Continued)

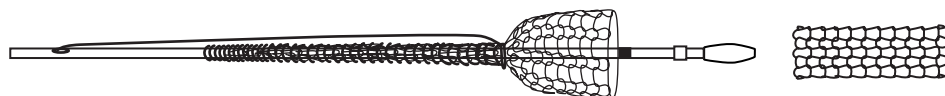

 Magnetic Resonance Conditional



Ultraflex™ Single-Use Uncovered Tracheobronchial Stent System – Distal Release*

| Order Number | GTIN | Description | Expanded Stent O.D. (mm) | Expanded Stent Length (mm) | Compressed Stent O.D. (Fr)** | Tip Max O.D. (mm) | Packaging |
|--------------|----------------|--------------------------|--------------------------|----------------------------|------------------------------|-------------------|-----------|
| M00576300 | 08714729837688 | Uncovered Distal Release | 10 | 30 | 15 | 4.1 | Each |
| M00576310 | 08714729837695 | Uncovered Distal Release | 12 | 30 | 17 | 4.1 | Each |
| M00576320 | 08714729837701 | Uncovered Distal Release | 14 | 30 | 18 | 4.1 | Each |
| M00576330 | 08714729837718 | Uncovered Distal Release | 16 | 40 | 20 | 5.3 | Each |
| M00576340 | 08714729837725 | Uncovered Distal Release | 16 | 60 | 20 | 5.3 | Each |
| M00576350 | 08714729837732 | Uncovered Distal Release | 18 | 40 | 20 | 5.3 | Each |
| M00576360 | 08714729837749 | Uncovered Distal Release | 18 | 60 | 20 | 5.3 | Each |
| M00576370 | 08714729837756 | Uncovered Distal Release | 20 | 40 | 20 | 5.3 | Each |
| M00576380 | 08714729837763 | Uncovered Distal Release | 20 | 60 | 20 | 5.3 | Each |

*Recommended Guidewire .035" Pulmonary Jagwire™ Pulmonary Guidewire, Order #1517, [▶](#) (Click here to view page 83).
Delivery System working length is 95cm.

**Data on File at Boston Scientific.



 Magnetic Resonance Conditional



Ultraflex Single-Use Uncovered Tracheobronchial Stent System – Proximal Release*

| Order Number | GTIN | Description | Expanded Stent O.D. (mm) | Expanded Stent Length (mm) | Compressed Stent O.D. (Fr)** | Tip Max O.D. (mm) | Packaging |
|--------------|----------------|----------------------------|--------------------------|----------------------------|------------------------------|-------------------|-----------|
| M00576410 | 08714729837770 | Uncovered Proximal Release | 8 | 20 | 15 | 4.1 | Each |
| M00576420 | 08714729837787 | Uncovered Proximal Release | 8 | 40 | 15 | 4.1 | Each |
| M00576430 | 08714729837794 | Uncovered Proximal Release | 10 | 20 | 15 | 4.1 | Each |
| M00576440 | 08714729837800 | Uncovered Proximal Release | 10 | 40 | 15 | 4.1 | Each |
| M00576450 | 08714729837817 | Uncovered Proximal Release | 12 | 20 | 17 | 4.1 | Each |
| M00576460 | 08714729837824 | Uncovered Proximal Release | 12 | 40 | 17 | 4.1 | Each |
| M00576470 | 08714729837831 | Uncovered Proximal Release | 14 | 20 | 18 | 4.1 | Each |
| M00576480 | 08714729837848 | Uncovered Proximal Release | 14 | 40 | 18 | 4.1 | Each |
| M00576490 | 08714729837855 | Uncovered Proximal Release | 14 | 60 | 18 | 4.1 | Each |

*Recommended Guidewire .035" Pulmonary Jagwire™ Pulmonary Guidewire, Order #1517, [▶](#) (Click here to view page 83).
Delivery System working length is 95cm.

**Data on File at Boston Scientific.



Section Table of Contents

Prev Page  78  Next Page

Main Table of Contents



Pulmonary

Airway Stents (Continued)

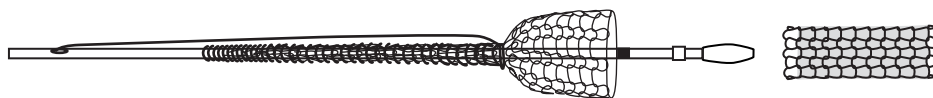

 Magnetic Resonance Conditional*



Ultraflex™ Single-Use Partially Covered Tracheobronchial Stent System – Distal Release

| Order Number | GTIN | Description | Expanded Stent O.D. (mm) | Expanded Stent Length (mm) | Covered Compressed Stent O.D. (Fr) | Cover Length (mm) | Tip Max O.D. (mm) | Packaging |
|--------------|---------------|----------------------------------|--------------------------|----------------------------|------------------------------------|-------------------|-------------------|-----------|
| M00576520 | 8714729842323 | Partially Covered Distal Release | 8 | 40 | 16 | 25 | 4.0 | Each |
| M00576530 | 8714729842330 | Partially Covered Distal Release | 10 | 30 | 18 | 15 | 4.0 | Each |
| M00576540 | 8714729842347 | Partially Covered Distal Release | 10 | 40 | 18 | 25 | 4.0 | Each |
| M00576550 | 8714729842354 | Partially Covered Distal Release | 12 | 30 | 20 | 15 | 4.0 | Each |
| M00576560 | 8714729842361 | Partially Covered Distal Release | 12 | 40 | 20 | 25 | 4.0 | Each |
| M00576570 | 8714729842378 | Partially Covered Distal Release | 14 | 30 | 24 | 15 | 4.0 | Each |
| M00576580 | 8714729842385 | Partially Covered Distal Release | 14 | 40 | 24 | 25 | 4.0 | Each |
| M00576590 | 8714729842392 | Partially Covered Distal Release | 14 | 60 | 24 | 45 | 4.0 | Each |
| M00576600 | 8714729842408 | Partially Covered Distal Release | 14 | 80 | 24 | 65 | 4.0 | Each |
| M00576610 | 8714729842415 | Partially Covered Distal Release | 16 | 40 | 25 | 25 | 5.1 | Each |
| M00576620 | 8714729842422 | Partially Covered Distal Release | 16 | 60 | 25 | 45 | 5.1 | Each |
| M00576630 | 8714729842439 | Partially Covered Distal Release | 16 | 80 | 25 | 65 | 5.1 | Each |
| M00576640 | 8714729842446 | Partially Covered Distal Release | 18 | 40 | 27 | 25 | 5.1 | Each |
| M00576650 | 8714729842453 | Partially Covered Distal Release | 18 | 60 | 27 | 45 | 5.1 | Each |
| M00576660 | 8714729842460 | Partially Covered Distal Release | 18 | 80 | 27 | 65 | 5.1 | Each |
| M00576670 | 8714729842477 | Partially Covered Distal Release | 20 | 40 | 27 | 25 | 5.1 | Each |
| M00576680 | 8714729842484 | Partially Covered Distal Release | 20 | 60 | 27 | 45 | 5.1 | Each |
| M00576690 | 8714729842491 | Partially Covered Distal Release | 20 | 80 | 27 | 65 | 5.1 | Each |

*Recommended Guidewire .035" Pulmonary Jagwire™ Pulmonary Guidewire, Order #1517.  (Click here to view page 83).

Delivery System working length is 95cm.

**Data on File at Boston Scientific.



Section Table of Contents

Prev Page  79  Next Page

Main Table of Contents



Pulmonary

Airway Stents (Continued)

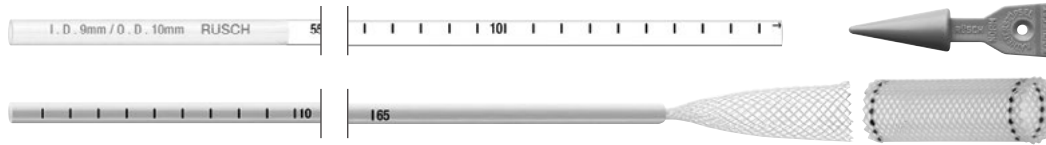

Polyflex™ Single-Use Self-Expanding Silicone Airway Stent



| Order Number | GTIN | Stent ID (mm) | Length (mm) | Delivery System Diameter (mm) | Packaging |
|--------------|----------------|---------------|-------------|-------------------------------|-----------|
| M00570000 | 08714729457138 | 8 | 20 | 7 | Each |
| M00570010 | 08714729457145 | 8 | 30 | 7 | Each |
| M00570020 | 08714729457152 | 10 | 20 | 8 | Each |
| M00570030 | 08714729457169 | 10 | 30 | 8 | Each |
| M00570040 | 08714729457176 | 10 | 40 | 8 | Each |
| M00570050 | 08714729457183 | 10 | 50 | 8 | Each |
| M00570060 | 08714729457190 | 12 | 20 | 9 | Each |
| M00570070 | 08714729457206 | 12 | 30 | 9 | Each |
| M00570080 | 08714729457213 | 12 | 40 | 9 | Each |
| M00570090 | 08714729457220 | 12 | 50 | 9 | Each |
| M00570100 | 08714729457237 | 14 | 20 | 9 | Each |
| M00570110 | 08714729457244 | 14 | 30 | 9 | Each |
| M00570120 | 08714729457251 | 14 | 40 | 9 | Each |
| M00570130 | 08714729457268 | 14 | 50 | 9 | Each |
| M00570140 | 08714729457275 | 14 | 60 | 9 | Each |
| M00570150 | 08714729457282 | 16 | 30 | 10 | Each |
| M00570160 | 08714729457299 | 16 | 40 | 10 | Each |
| M00570170 | 08714729457305 | 16 | 50 | 10 | Each |
| M00570180 | 08714729457312 | 16 | 60 | 10 | Each |
| M00570190 | 08714729457329 | 16 | 70 | 10 | Each |
| M00570200 | 08714729457336 | 18 | 30 | 11 | Each |
| M00570210 | 08714729457343 | 18 | 40 | 11 | Each |
| M00570220 | 08714729457350 | 18 | 50 | 11 | Each |
| M00570230 | 08714729457367 | 18 | 60 | 11 | Each |
| M00570240 | 08714729457374 | 18 | 70 | 11 | Each |
| M00570250 | 08714729457381 | 18 | 80 | 11 | Each |
| M00570260 | 08714729457398 | 20 | 40 | 12 | Each |
| M00570270 | 08714729457404 | 20 | 50 | 12 | Each |
| M00570280 | 08714729457411 | 20 | 60 | 12 | Each |
| M00570290 | 08714729457428 | 20 | 70 | 12 | Each |
| M00570300 | 08714729457435 | 20 | 80 | 12 | Each |
| M00570310 | 08714729457442 | 22 | 50 | 13 | Each |
| M00570320 | 08714729457459 | 22 | 60 | 13 | Each |
| M00570330 | 08714729457466 | 22 | 80 | 13 | Each |



Pulmonary

Biopsy Forceps

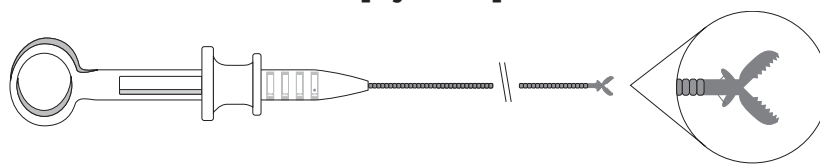

Radial Jaw™ 4 Single-Use Pulmonary Biopsy Forceps



| Order Number | GTIN | Description | Differentiator | Jaw O.D. (mm) | Working Length (cm) | Minimum Working Channel (mm) | Packaging |
|--------------|----------------|---------------------------|---------------------------------------|---------------|---------------------|------------------------------|-----------|
| M00515181 | 08714729792864 | Single-Use Biopsy Forceps | Pulmonary Standard Capacity | 1.8 | 100 | 2.0 | Box 5 |
| M00515182 | 08714729799337 | Single-Use Biopsy Forceps | Pulmonary Standard Capacity | 1.8 | 100 | 2.0 | Box 20 |
| M00515191 | 08714729792871 | Single-Use Biopsy Forceps | Pulmonary Standard Capacity w/ Needle | 1.8 | 100 | 2.0 | Box 5 |
| M00515192 | 08714729818083 | Single-Use Biopsy Forceps | Pulmonary Standard Capacity w/ Needle | 1.8 | 100 | 2.0 | Box 20 |
| M00515201 | 08714729793281 | Single-Use Biopsy Forceps | Pulmonary Large Capacity | 2.2 | 100 | 2.8 | Box 5 |
| M00515202 | 08714729818076 | Single-Use Biopsy Forceps | Pulmonary Large Capacity | 2.2 | 100 | 2.8 | Box 20 |

Transbronchial Aspiration Needles

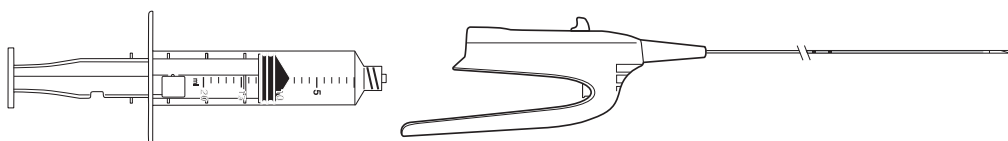

eXcelon™ Transbronchial Aspiration Needle*



| Order Number | GTIN | Description | Needle Gauge | Needle Length (mm) | Catheter Length (cm) | Sheath O.D. (mm) | Packaging |
|--------------|----------------|--|--------------|--------------------|----------------------|------------------|-----------|
| M00564101 | 08714729456452 | eXcelon Transbronchial Aspiration Needle | 19 | 15 | 130 | 1.8 | Box 5 |
| M00564111 | 08714729456469 | eXcelon Transbronchial Aspiration Needle | 20 | 15 | 130 | 1.8 | Box 5 |
| M00564121 | 08714729456476 | eXcelon Transbronchial Aspiration Needle | 21 | 15 | 130 | 1.8 | Box 5 |

*Packaging also includes a 20ml syringe.



Section Table of Contents

Prev Page ◀ 81 ▶ Next Page

Main Table of Contents



Pulmonary

Cytology Brushes

Celebrity™ Single-Use Endoscopic Cytology Brush – Bronchoscope



| Order Number | GTIN | Required Working Channel (mm) | Bristle O.D. (mm) | Sheath Length (cm) | Packaging |
|--------------|----------------|-------------------------------|-------------------|--------------------|-----------|
| M00516001 | 08714729138983 | 2.0 | 1.0 | 140 | Box 10 |
| M00516011 | 08714729138990 | 2.0 | 1.5 | 140 | Box 10 |
| M00516071 | 08714729139089 | 2.0 | 1.9 | 100 | Box 10 |
| M00516151 | 08714729014003 | 2.0 | 1.9 | 150 | Box 10 |

Airway Retrieval Baskets

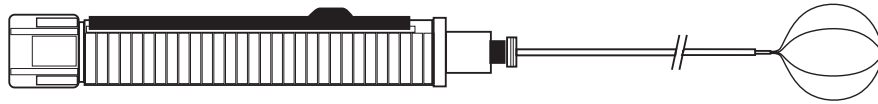

Zero Tip™ Airway Retrieval Basket



| Order Number | GTIN | Description | Sheath O.D. (mm) | Working Length (cm) | Basket Opening (mm) | Packaging |
|--------------|----------------|----------------------------------|------------------|---------------------|---------------------|-----------|
| M00513200 | 08714729414995 | Zero Tip Airway Retrieval Basket | 0.8 | 120 | 12 | Each |
| M00513210 | 08714729415008 | Zero Tip Airway Retrieval Basket | 1.0 | 120 | 16 | Each |



Pulmonary

Controlled Radial Expansion Pulmonary Balloon Dilators



CRE™ Single-Use Pulmonary Balloon Dilator*



| Order Number | GTIN | Balloon Inflated O.D. | | Balloon Length (cm) | Inflation Pressures | | Catheter Length (cm) | Packaging |
|--------------|----------------|-----------------------|------------|---------------------|---------------------|-------------|----------------------|-----------|
| | | (mm) | (Fr) | | (ATM) | (kPa) | | |
| M00550300 | 08714729456186 | 12-13.5-15 | 36-40.5-45 | 5.5 | 3-4.5-8 | 304-456-811 | 75 | Each |
| M00550310 | 08714729456193 | 15-16.5-18 | 45-49.5-54 | 5.5 | 3-4.5-7 | 304-456-709 | 75 | Each |
| M00550320 | 08714729456209 | 18-19-20 | 54-57-60 | 5.5 | 3-4.5-6 | 304-456-608 | 75 | Each |
| M00550330 | 08714729456216 | 8-9-10 | 24-27-30 | 3.0 | 3-5.5-9 | 304-557-912 | 75 | Each |
| M00550340 | 08714729456223 | 10-11-12 | 30-33-36 | 3.0 | 3-5-8 | 304-507-811 | 75 | Each |
| M00550350 | 08714729456230 | 12-13.5-15 | 36-40.5-45 | 3.0 | 3-4.5-8 | 304-456-811 | 75 | Each |

*Recommended Inflation Device: Alliance™ II Integrated Inflation System, Handle Order #5062, Sterile Syringe Order #5060 (see below).

Pulmonary Guidewires

Pulmonary Jagwire™ Pulmonary Guidewire



| Order Number | GTIN | Description | O.D. (in) | Length (cm) | Packaging |
|--------------|----------------|---------------------------------------|-----------|-------------|-----------|
| M00515171 | 08714729455813 | Pulmonary Jagwire Pulmonary Guidewire | .035 | 180 | Box 2 |

Inflation System

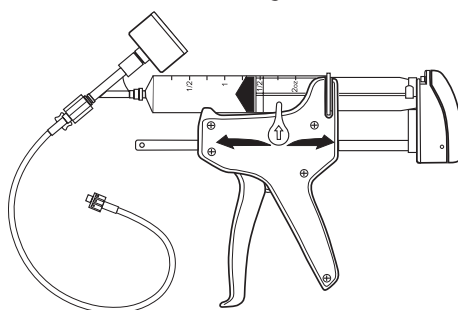

Alliance II Inflation System

| Order Number | GTIN | Description | Packaging |
|--------------|----------------|-------------------------------------|-----------|
| M00550620 | 08714729283881 | Inflation Handle | Each |
| M00550601 | 08714729129332 | Single-Use Syringe / Gauge Assembly | Box 5 |



Notes and Future Product Updates



Services

- **GuidePoint Reimbursement Solutions** ..85
- **Supply Chain Essentials**86
- **Lean Essentials**86



Services

GuidePoint Reimbursement Solutions

The Endoscopy Health Economics and Reimbursement (HE&R) Team offers a suite of reimbursement services and support for healthcare professionals seeking a better understanding of reimbursement for Boston Scientific's Endoscopy and Pulmonary products and procedures. We can help you develop a base level of knowledge in coding, coverage and payment for these procedures and offer educational presentations and webinars on topics like the Affordable Care Act and changes to Medicare reimbursement impacting providers and facilities. Other offerings include coding and billing audits and facility-specific reimbursement information, benchmarking data, and support.

About Our Team

Boston Scientific Endoscopy's HE&R Team is comprised of highly skilled professionals specializing in reimbursement, health economics and health policy issues. The team has a broad background with experience working for public and private payers, medical associations, healthcare consulting agencies and academic research organizations. We use clinical and economic outcomes data and collaborate with outside experts to promote appropriate coding, coverage and reimbursement for Boston Scientific Endoscopy and Pulmonary products and procedures.

Contact Information

For more information about Boston Scientific Endoscopy's GuidePoint Reimbursement Solutions, please contact our **Health Economics and Reimbursement department at 800-876-9960 x54510 or ENDOREIMBURSEMENT@bsci.com**.

www.bostonscientific.com/reimbursement

Health economic and reimbursement information provided by Boston Scientific Corporation is gathered from third-party sources and is subject to change without notice as a result of complex and frequently changing laws, regulations, rules and policies. This information is presented for illustrative purposes only and does not constitute reimbursement or legal advice. Boston Scientific encourages providers to submit accurate and appropriate claims for services. It is always the provider's responsibility to determine medical necessity, the proper site for delivery of any services and to submit appropriate codes, charges, and modifiers for services that are rendered. Boston Scientific recommends that you consult with your payers, reimbursement specialists and/or legal counsel regarding coding, coverage and reimbursement matters. Boston Scientific does not promote the use of its products outside their FDA-approved label.



Services

Supply Chain Essentials

Supply Chain Essentials is a distinct organization within Boston Scientific created to improve efficiency of the entire healthcare supply chain. Collaborating with providers and utilizing our expertise, we develop a strategic approach for identifying solutions focused on operational efficiencies and cost savings that:

- Reduce cost and time consumed on inventory management
- Optimize and automate the end-to-end order management process
- Increase order accuracy and reduce out-of-stock situations
- Reduce waste associated with expired product

We will work collaboratively with you to develop scalable efficiencies that achieve savings across your supply chain.

Start saving today! Email your Supply Chain Essentials representative at SupplyChainEssentials@bsci.com.

Lean Essentials

Lean Essentials is a program that enables and drives improvements in patient experience, staff satisfaction, quality and efficiency and total cost of care. We have a team of experts dedicated to reducing variation and waste and improving on overall work flow processes.

To improve on overall processes and implementing standardization of care, our approach is a continuous three-step process that leads key personnel from the current state to the future state:

- **Assessment:** Evaluate the project, establish success metrics and identify a core team
- **Implementation:** Map the current state and design the improved future state
- **Monitoring:** Evaluate and report on performance of new processes, recognize the core team and execute final review

Boston Scientific values operational efficiency, financial health, quality outcomes and patient experience just like your institution does. We've applied programs like Lean Essentials to achieve significant, measurable, sustainable results.

To learn more about how you can bring Lean Essentials to your healthcare organization email leanessentials@bsci.com.





Biopsy

Forceps

- ▶ Radial Jaw™ 3 Single-Use Max Capacity Biopsy Forceps87

While in Stock

Forceps

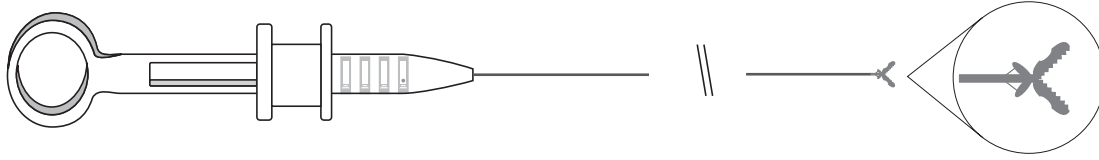

Radial Jaw™ 3 Single-Use Max Capacity Biopsy Forceps



| Order Number | GTIN | Description | Jaw O.D. (mm) | Working Length (cm) | Minimum Working Channel (mm) | Color Code | Packaging |
|--------------|----------------|---|---------------|---------------------|------------------------------|------------|-----------|
| M00515861 | 08714729096092 | Radial Jaw 3 Max Capacity Forceps | 3.3 | 160 | 3.7 | Yellow | Box 5 |
| M00515871 | 08714729085799 | Radial Jaw 3 Max Capacity Forceps w/ Needle | 3.3 | 160 | 3.7 | Yellow | Box 5 |
| M00515881 | 08714729085805 | Radial Jaw 3 Max Capacity Forceps | 3.3 | 240 | 3.7 | Orange | Box 5 |
| M00515891 | 08714729096108 | Radial Jaw 3 Max Capacity Forceps w/ Needle | 3.3 | 240 | 3.7 | Orange | Box 5 |
| M00515892 | 08714729718802 | Radial Jaw 3 Max Capacity Forceps w/ Needle | 3.3 | 240 | 3.7 | Orange | Box 20 |



Notes and Future Product Updates



Future Product Updates



Notes and Future Product Updates

Blank lined area for notes and future product updates.

Notes and Future Product Updates



Product Code Index

🔍 Begins on Page91

Product Code Index

| Product Code | Description | Page # | Product Code | Description | Page # |
|--------------|--|--------|--------------|---|--------|
| H965180011 | WALLSTENT™ or WallFlex™ Single-Use GI Guidewire – Tapered | 44 | M00513373 | Radial Jaw 4 Single-Use Jumbo Biopsy Forceps w/ Needle | 61 |
| H965430100 | WALLSTENT Endoscopic Biliary Endoprosthesis Stents | 19 | M00513381 | Radial Jaw 4 Standard Capacity Single-Use Biopsy Forceps | 61 |
| H965430200 | WALLSTENT Endoscopic Biliary Endoprosthesis Stents | 19 | M00513382 | Radial Jaw 4 Standard Capacity Single-Use Biopsy Forceps | 61 |
| H965430300 | WALLSTENT Endoscopic Biliary Endoprosthesis Stents | 19 | M00513383 | Radial Jaw 4 Standard Capacity Single-Use Biopsy Forceps | 61 |
| H965430400 | WALLSTENT Endoscopic Biliary Endoprosthesis Stents | 19 | M00513391 | Radial Jaw 4 Standard Capacity Single-Use Biopsy Forceps w/ Needle | 61 |
| H965430500 | WALLSTENT Endoscopic Biliary Endoprosthesis Stents | 19 | M00513392 | Radial Jaw 4 Standard Capacity Single-Use Biopsy Forceps w/ Needle | 61 |
| H965430600 | WALLSTENT Endoscopic Biliary Endoprosthesis Stents | 19 | M00513393 | Radial Jaw 4 Standard Capacity Single-Use Biopsy Forceps w/ Needle | 61 |
| H965430700 | WALLSTENT Endoscopic Biliary Endoprosthesis Stents | 19 | M00513401 | Radial Jaw 4 Standard Capacity Single-Use Biopsy Forceps | 61 |
| H965430800 | WALLSTENT Endoscopic Biliary Endoprosthesis Stents | 19 | M00513402 | Radial Jaw 4 Standard Capacity Single-Use Biopsy Forceps | 61 |
| H965430900 | WALLSTENT Endoscopic Biliary Endoprosthesis Stents | 19 | M00513403 | Radial Jaw 4 Standard Capacity Single-Use Biopsy Forceps | 61 |
| H965431000 | WALLSTENT Endoscopic Biliary Endoprosthesis Stents | 19 | M00513411 | Radial Jaw 4 Standard Capacity Single-Use Biopsy Forceps w/ Needle | 61 |
| H965431100 | WALLSTENT Endoscopic Biliary Endoprosthesis Stents | 19 | M00513412 | Radial Jaw 4 Standard Capacity Single-Use Biopsy Forceps w/ Needle | 61 |
| H965431200 | WALLSTENT Endoscopic Biliary Endoprosthesis Stents | 19 | M00513413 | Radial Jaw 4 Standard Capacity Single-Use Biopsy Forceps w/ Needle | 61 |
| M00510101 | Multibite™ Single-Use Multiple Sample Biopsy Forceps | 63 | M00513443 | Radial Jaw 4 Single-Use Pediatric Biopsy Forceps | 62 |
| M00510121 | Multibite Single-Use Multiple Sample Biopsy Forceps | 63 | M00513453 | Radial Jaw 4 Single-Use Pediatric Biopsy Forceps w/ Needle | 62 |
| M00510860 | Trapezoid™ RX Wireguided Retrieval Basket | 33 | M00513700 | Ultraflex™ Single-Use Uncovered Esophageal NG Stent System – Distal Release | 47 |
| M00510870 | Trapezoid RX Wireguided Retrieval Basket | 33 | M00513710 | Ultraflex Single-Use Uncovered Esophageal NG Stent System – Distal Release | 47 |
| M00510880 | Trapezoid RX Wireguided Retrieval Basket | 33 | M00513720 | Ultraflex Single-Use Uncovered Esophageal NG Stent System – Distal Release | 47 |
| M00510890 | Trapezoid RX Wireguided Retrieval Basket | 33 | M00513730 | Ultraflex Single-Use Covered Esophageal NG Stent System – Distal Release | 46 |
| M00511731 | Optiflo™ Single-Use Hemostasis Catheters | 51 | M00513740 | Ultraflex Single-Use Covered Esophageal NG Stent System – Distal Release | 46 |
| M00511751 | Optiflo Single-Use Hemostasis Catheters | 51 | M00513750 | Ultraflex Single-Use Covered Esophageal NG Stent System – Distal Release | 46 |
| M00513200 | Zero Tip™ Airway Retrieval Basket | 82 | M00513800 | Ultraflex Single-Use Uncovered Esophageal NG Stent System – Proximal Release | 47 |
| M00513210 | Zero Tip Airway Retrieval Basket | 82 | M00513810 | Ultraflex Single-Use Uncovered Esophageal NG Stent System – Proximal Release | 47 |
| M00513301 | Radial Jaw™ 4 Single-Use Large Capacity Biopsy Forceps | 61 | M00513830 | Ultraflex Single-Use Uncovered Esophageal NG Stent System – Proximal Release | 47 |
| M00513302 | Radial Jaw 4 Single-Use Large Capacity Biopsy Forceps | 61 | M00513840 | Ultraflex Single-Use Covered Esophageal NG Stent System – Proximal Release | 46 |
| M00513303 | Radial Jaw 4 Single-Use Large Capacity Biopsy Forceps | 61 | M00513850 | Ultraflex Single-Use Covered Esophageal NG Stent System – Proximal Release | 46 |
| M00513311 | Radial Jaw 4 Single-Use Large Capacity Biopsy Forceps w/ Needle | 61 | M00513860 | Ultraflex Single-Use Covered Esophageal NG Stent System – Proximal Release | 46 |
| M00513312 | Radial Jaw 4 Single-Use Large Capacity Biopsy Forceps w/ Needle | 61 | M00514200 | Ultraflex Single-Use Covered Large Esophageal NG Stent System – Distal Release | 47 |
| M00513313 | Radial Jaw 4 Single-Use Large Capacity Biopsy Forceps w/ Needle | 61 | M00514210 | Ultraflex Single-Use Covered Large Esophageal NG Stent System – Distal Release | 47 |
| M00513321 | Radial Jaw 4 Single-Use Large Capacity Biopsy Forceps | 61 | M00514240 | Ultraflex Single-Use Covered Large Esophageal NG Stent System – Proximal Release | 47 |
| M00513322 | Radial Jaw 4 Single-Use Large Capacity Biopsy Forceps | 61 | M00514250 | Ultraflex Single-Use Covered Large Esophageal NG Stent System – Proximal Release | 47 |
| M00513323 | Radial Jaw 4 Single-Use Large Capacity Biopsy Forceps | 61 | | | |
| M00513331 | Radial Jaw 4 Single-Use Large Capacity Biopsy Forceps w/ Needle | 61 | | | |
| M00513332 | Radial Jaw 4 Single-Use Large Capacity Biopsy Forceps w/ Needle | 61 | | | |
| M00513333 | Radial Jaw 4 Single-Use Large Capacity Biopsy Forceps w/ Needle | 61 | | | |
| M00513343 | Radial Jaw 4 Single-Use Jumbo Biopsy Forceps | 61 | | | |
| M00513353 | Radial Jaw 4 Single-Use Jumbo Biopsy Forceps w/ Needle | 61 | | | |
| M00513361 | Radial Jaw 4 Single-Use Jumbo Biopsy Forceps | 61 | | | |
| M00513362 | Radial Jaw 4 Single-Use Jumbo Biopsy Forceps | 61 | | | |
| M00513363 | Radial Jaw 4 Single-Use Jumbo Biopsy Forceps | 61 | | | |
| M00513371 | Radial Jaw 4 Single-Use Jumbo Biopsy Forceps w/ Needle | 61 | | | |
| M00513372 | Radial Jaw 4 Single-Use Jumbo Biopsy Forceps w/ Needle | 61 | | | |

Product Code Index

| Product Code | Description | Page # | Product Code | Description | Page # |
|--------------|--|--------|--------------|---|--------|
| M00514270 | Polyflex™ Single-Use Esophageal Stent System | 46 | M00516920 | WallFlex Partially Covered Esophageal Stent | 45 |
| M00514280 | Polyflex Single-Use Esophageal Stent System | 46 | M00516930 | WallFlex Partially Covered Esophageal Stent | 45 |
| M00514290 | Polyflex Single-Use Esophageal Stent System | 46 | M00516940 | WallFlex Partially Covered Esophageal Stent | 45 |
| M00514300 | Polyflex Single-Use Esophageal Stent System | 46 | M00516950 | WallFlex Partially Covered Esophageal Stent | 45 |
| M00514310 | Polyflex Single-Use Esophageal Stent System | 46 | M00518101 | Interject™ Clear Single-Use Injection Therapy Needle Catheters | 50 |
| M00514320 | Polyflex Single-Use Esophageal Stent System | 46 | M00518111 | Interject Clear Single-Use Injection Therapy Needle Catheters | 50 |
| M00514330 | Polyflex Single-Use Esophageal Stent System | 46 | M00518151 | Interject Contrast Single-Use Injection Therapy Needle Catheters | 50 |
| M00514340 | Polyflex Single-Use Esophageal Stent System | 46 | M00518161 | Interject Contrast Single-Use Injection Therapy Needle Catheters | 50 |
| M00514350 | Polyflex Single-Use Esophageal Stent System | 46 | M00518251 | Interject Contrast Single-Use Injection Therapy Needle Catheters | 50 |
| M00515031 | Radial Jaw™ 4 Single-Use Hot Biopsy Forceps | 62 | M00518261 | Interject Contrast Single-Use Injection Therapy Needle Catheters | 50 |
| M00515032 | Radial Jaw 4 Single-Use Hot Biopsy Forceps | 62 | M00518301 | Interject Clear Single-Use Injection Therapy Needle Catheters | 50 |
| M00515033 | Radial Jaw 4 Single-Use Hot Biopsy Forceps | 62 | M00518311 | Interject Clear Single-Use Injection Therapy Needle Catheters | 50 |
| M00515171 | Pulmonary Jagwire™ Pulmonary Guidewire | 83 | M00518351 | Interject Contrast Single-Use Injection Therapy Needle Catheters | 50 |
| M00515181 | Radial Jaw 4 Single-Use Pulmonary Forceps – Standard Capacity | 81 | M00518361 | Interject Contrast Single-Use Injection Therapy Needle Catheters | 50 |
| M00515182 | Radial Jaw 4 Single-Use Pulmonary Forceps – Standard Capacity | 81 | M00522600 | Resolution™ Clip | 49 |
| M00515191 | Radial Jaw 4 Single-Use Pulmonary Forceps – Standard Capacity with Needle | 81 | M00522601 | Resolution Clip | 49 |
| M00515192 | Radial Jaw 4 Single-Use Pulmonary Forceps – Standard Capacity with Needle | 81 | M00522602 | Resolution Clip | 49 |
| M00515201 | Radial Jaw 4 Single-Use Pulmonary Forceps – Large Capacity | 81 | M00522610 | Resolution Clip | 49 |
| M00515202 | Radial Jaw 4 Single-Use Pulmonary Forceps – Large Capacity | 81 | M00522611 | Resolution Clip | 49 |
| M00515861 | Radial Jaw 3 Single-Use Max Capacity Biopsy Forceps | 87 | M00522612 | Resolution Clip | 49 |
| M00515871 | Radial Jaw 3 Single-Use Max Capacity Biopsy Forceps w/ Needle | 87 | M00530800 | Ultratome™ Double-Lumen Sphincterotome – Short Nose | 12 |
| M00515881 | Radial Jaw 3 Single-Use Max Capacity Biopsy Forceps | 87 | M00530810 | Ultratome Double-Lumen Sphincterotome – Long Nose | 12 |
| M00515891 | Radial Jaw 3 Single-Use Max Capacity Biopsy Forceps w/ Needle | 87 | M00530820 | Ultratome Double-Lumen Sphincterotome – Short Nose | 12 |
| M00515892 | Radial Jaw 3 Single-Use Max Capacity Biopsy Forceps w/ Needle | 87 | M00530830 | Ultratome Double-Lumen Sphincterotome – Long Nose | 12 |
| M00516001 | Celebrity™ Single-Use Endoscopic Cytology Brush – Bronchoscope | 82 | M00530850 | Contour™ ERCP Cannulas – Standard | 13 |
| M00516011 | Celebrity Single-Use Endoscopic Cytology Brush – Bronchoscope | 82 | M00530860 | Contour ERCP Cannulas – Tapered | 13 |
| M00516071 | Celebrity Single-Use Endoscopic Cytology Brush – Bronchoscope | 82 | M00530870 | Contour ERCP Cannulas – Ultra Tapered | 13 |
| M00516151 | Celebrity Single-Use Endoscopic Cytology Brush – Bronchoscope | 82 | M00530880 | Contour ERCP Cannulas – 5-4-3 | 13 |
| M00516700 | WallFlex™ Fully Covered Esophageal Stent | 45 | M00530890 | Contour ERCP Cannulas – Ball Tip | 13 |
| M00516710 | WallFlex Fully Covered Esophageal Stent | 45 | M00530960 | Fuoro Tip™ Single-Use ERCP Cannulas – Standard Tip | 13 |
| M00516720 | WallFlex Fully Covered Esophageal Stent | 45 | M00530970 | Fuoro Tip Single-Use ERCP Cannulas – Tapered Tip | 13 |
| M00516730 | WallFlex Fully Covered Esophageal Stent | 45 | M00530980 | Fuoro Tip Single-Use ERCP Cannulas – Ultra Tapered Tip | 13 |
| M00516740 | WallFlex Fully Covered Esophageal Stent | 45 | M00532010 | C-Flex™ Double Pigtail Biliary Stent | 25 |
| M00516750 | WallFlex Fully Covered Esophageal Stent | 45 | M00532020 | C-Flex Double Pigtail Biliary Stent | 25 |
| M00516900 | WallFlex Partially Covered Esophageal Stent | 45 | M00532030 | C-Flex Double Pigtail Biliary Stent | 25 |
| M00516910 | WallFlex Partially Covered Esophageal Stent | 45 | M00532040 | C-Flex Double Pigtail Biliary Stent | 25 |
| | | | M00532050 | C-Flex Double Pigtail Biliary Stent | 25 |
| | | | M00532160 | Advanix™ Double Pigtail - Single Stent | 22 |
| | | | M00532180 | Advanix Double Pigtail - Single Stent | 22 |

Product Code Index

| Product Code | Description | Page # | Product Code | Description | Page # |
|--------------|--|--------|--------------|--|--------|
| M00532190 | Advanix™ Double Pigtail - Single Stent | 22 | M00533400 | Advanix Center Bend - Single Stent | 21 |
| M00532210 | Advanix Double Pigtail - Single Stent | 22 | M00533560 | NaviFlex™ RX Delivery System | 22 |
| M00532220 | Advanix Double Pigtail - Single Stent | 22 | M00533570 | NaviFlex RX Delivery System | 22 |
| M00532230 | Advanix Double Pigtail - Single Stent | 22 | M00533580 | NaviFlex RX Delivery System | 22 |
| M00532240 | Advanix Double Pigtail - Single Stent | 22 | M00533610 | Percuflex™ Duodenal Bend Biliary Stent | 24 |
| M00532260 | Advanix Double Pigtail - Single Stent | 22 | M00533620 | Percuflex Duodenal Bend Biliary Stent | 24 |
| M00532270 | Advanix Double Pigtail - Single Stent | 22 | M00533630 | Percuflex Duodenal Bend Biliary Stent | 24 |
| M00532290 | Advanix Double Pigtail - Single Stent | 22 | M00533640 | Percuflex Duodenal Bend Biliary Stent | 24 |
| M00532300 | Advanix Double Pigtail - Single Stent | 22 | M00533650 | Percuflex Duodenal Bend Biliary Stent | 24 |
| M00532310 | Advanix Double Pigtail - Single Stent | 22 | M00533660 | Percuflex Duodenal Bend Biliary Stent | 24 |
| M00532810 | MicroKnife™ XL Triple-Lumen Needle Knife | 10 | M00533670 | Percuflex Duodenal Bend Biliary Stent | 24 |
| M00532870 | Advanix Duodenal Bend - Single Stent | 21 | M00533680 | Percuflex Duodenal Bend Biliary Stent | 24 |
| M00532880 | Advanix Duodenal Bend - Single Stent | 21 | M00533690 | Percuflex Duodenal Bend Biliary Stent | 24 |
| M00532890 | Advanix Duodenal Bend - Single Stent | 21 | M00533700 | Percuflex Duodenal Bend Biliary Stent | 24 |
| M00532900 | Advanix Duodenal Bend - Single Stent | 21 | M00533760 | Percuflex Duodenal Bend Biliary Stent w/ Push Catheter | 24 |
| M00532910 | Advanix Duodenal Bend - Single Stent | 21 | M00533770 | Percuflex Duodenal Bend Biliary Stent w/ Push Catheter | 24 |
| M00532920 | Advanix Duodenal Bend - Single Stent | 21 | M00533780 | Percuflex Duodenal Bend Biliary Stent w/ Push Catheter | 24 |
| M00532930 | Advanix Duodenal Bend - Single Stent | 21 | M00533790 | Percuflex Duodenal Bend Biliary Stent w/ Push Catheter | 24 |
| M00532940 | Advanix Duodenal Bend - Single Stent | 21 | M00533800 | Percuflex Duodenal Bend Biliary Stent w/ Push Catheter | 24 |
| M00532950 | Advanix Duodenal Bend - Single Stent | 21 | M00533810 | Percuflex Duodenal Bend Biliary Stent w/ Push and Guide Catheter | 24 |
| M00532960 | Advanix Duodenal Bend - Single Stent | 21 | M00533820 | Percuflex Duodenal Bend Biliary Stent w/ Push and Guide Catheter | 24 |
| M00532970 | Advanix Duodenal Bend - Single Stent | 21 | M00533830 | Percuflex Duodenal Bend Biliary Stent w/ Push and Guide Catheter | 24 |
| M00532980 | Advanix Duodenal Bend - Single Stent | 21 | M00533840 | Percuflex Duodenal Bend Biliary Stent w/ Push and Guide Catheter | 24 |
| M00532990 | Advanix Duodenal Bend - Single Stent | 21 | M00533850 | Percuflex Duodenal Bend Biliary Stent w/ Push and Guide Catheter | 24 |
| M00533000 | Advanix Duodenal Bend - Single Stent | 21 | M00533910 | Biliary Introducer – Push Catheter | 24 |
| M00533010 | Advanix Duodenal Bend - Single Stent | 21 | M00533920 | Biliary Introducer – Push and Guide Catheter | 24 |
| M00533020 | Advanix Duodenal Bend - Single Stent | 21 | M00534200 | Advanix Duodenal Bend Preloaded RX Stent Systems | 20 |
| M00533030 | Advanix Duodenal Bend - Single Stent | 21 | M00534210 | Advanix Duodenal Bend Preloaded RX Stent Systems | 20 |
| M00533040 | Advanix Duodenal Bend - Single Stent | 21 | M00534220 | Advanix Duodenal Bend Preloaded RX Stent Systems | 20 |
| M00533230 | Advanix Center Bend - Single Stent | 21 | M00534230 | Advanix Duodenal Bend Preloaded RX Stent Systems | 20 |
| M00533240 | Advanix Center Bend - Single Stent | 21 | M00534240 | Advanix Duodenal Bend Preloaded RX Stent Systems | 20 |
| M00533250 | Advanix Center Bend - Single Stent | 21 | M00534250 | Advanix Duodenal Bend Preloaded RX Stent Systems | 20 |
| M00533260 | Advanix Center Bend - Single Stent | 21 | M00534260 | Advanix Duodenal Bend Preloaded RX Stent Systems | 20 |
| M00533270 | Advanix Center Bend - Single Stent | 21 | M00534270 | Advanix Duodenal Bend Preloaded RX Stent Systems | 20 |
| M00533280 | Advanix Center Bend - Single Stent | 21 | M00534280 | Advanix Duodenal Bend Preloaded RX Stent Systems | 20 |
| M00533290 | Advanix Center Bend - Single Stent | 21 | M00534290 | Advanix Duodenal Bend Preloaded RX Stent Systems | 20 |
| M00533300 | Advanix Center Bend - Single Stent | 21 | M00534300 | Advanix Duodenal Bend Preloaded RX Stent Systems | 20 |
| M00533310 | Advanix Center Bend - Single Stent | 21 | M00534310 | Advanix Duodenal Bend Preloaded RX Stent Systems | 20 |
| M00533320 | Advanix Center Bend - Single Stent | 21 | M00534320 | Advanix Duodenal Bend Preloaded RX Stent Systems | 20 |
| M00533330 | Advanix Center Bend - Single Stent | 21 | M00534330 | Advanix Duodenal Bend Preloaded RX Stent Systems | 20 |
| M00533340 | Advanix Center Bend - Single Stent | 21 | M00534340 | Advanix Duodenal Bend Preloaded RX Stent Systems | 20 |
| M00533350 | Advanix Center Bend - Single Stent | 21 | M00534350 | Advanix Duodenal Bend Preloaded RX Stent Systems | 20 |
| M00533360 | Advanix Center Bend - Single Stent | 21 | | | |
| M00533370 | Advanix Center Bend - Single Stent | 21 | | | |
| M00533380 | Advanix Center Bend - Single Stent | 21 | | | |
| M00533390 | Advanix Center Bend - Single Stent | 21 | | | |

Product Code Index

| Product Code | Description | Page # | Product Code | Description | Page # |
|--------------|--|--------|--------------|--|--------|
| M00534360 | Advanix™ Duodenal Bend Preloaded RX Stent Systems | 20 | M00536080 | Advanix Pancreatic Stent – Straight, No Leading Barb | 27 |
| M00534370 | Advanix Duodenal Bend Preloaded RX Stent Systems | 20 | M00536090 | Advanix Pancreatic Stent – Straight, No Leading Barb | 27 |
| M00534560 | Advanix Center Bend Preloaded RX Stent Systems | 20 | M00536100 | Advanix Pancreatic Stent – Straight, No Leading Barb | 27 |
| M00534570 | Advanix Center Bend Preloaded RX Stent Systems | 20 | M00536110 | Advanix Pancreatic Stent – Straight, No Leading Barb | 27 |
| M00534580 | Advanix Center Bend Preloaded RX Stent Systems | 20 | M00536120 | Advanix Pancreatic Stent – Straight, No Leading Barb | 27 |
| M00534590 | Advanix Center Bend Preloaded RX Stent Systems | 20 | M00536130 | Advanix Pancreatic Stent – Straight, No Leading Barb | 27 |
| M00534600 | Advanix Center Bend Preloaded RX Stent Systems | 20 | M00536140 | Advanix Pancreatic Stent – Straight, No Leading Barb | 27 |
| M00534610 | Advanix Center Bend Preloaded RX Stent Systems | 20 | M00536150 | Advanix Pancreatic Stent – Straight, No Leading Barb | 27 |
| M00534620 | Advanix Center Bend Preloaded RX Stent Systems | 20 | M00536160 | Advanix Pancreatic Stent – Straight, No Leading Barb | 27 |
| M00534630 | Advanix Center Bend Preloaded RX Stent Systems | 20 | M00536170 | Advanix Pancreatic Stent – Straight, No Leading Barb | 27 |
| M00534640 | Advanix Center Bend Preloaded RX Stent Systems | 20 | M00536180 | Advanix Pancreatic Stent – Straight, No Leading Barb | 27 |
| M00534650 | Advanix Center Bend Preloaded RX Stent Systems | 20 | M00536190 | Advanix Pancreatic Stent – Straight, No Leading Barb | 27 |
| M00534660 | Advanix Center Bend Preloaded RX Stent Systems | 20 | M00536200 | Advanix Pancreatic Stent – Straight, No Leading Barb | 27 |
| M00534670 | Advanix Center Bend Preloaded RX Stent Systems | 20 | M00536210 | Advanix Pancreatic Stent – Straight, No Leading Barb | 27 |
| M00534680 | Advanix Center Bend Preloaded RX Stent Systems | 20 | M00536220 | Advanix Pancreatic Stent – Straight, No Leading Barb | 27 |
| M00534690 | Advanix Center Bend Preloaded RX Stent Systems | 20 | M00536230 | Advanix Pancreatic Stent – Straight, No Leading Barb | 27 |
| M00534700 | Advanix Center Bend Preloaded RX Stent Systems | 20 | M00536240 | Advanix Pancreatic Stent – Straight, No Leading Barb | 27 |
| M00534710 | Advanix Center Bend Preloaded RX Stent Systems | 20 | M00536250 | Advanix Pancreatic Stent – Straight, No Leading Barb | 27 |
| M00534720 | Advanix Center Bend Preloaded RX Stent Systems | 20 | M00536260 | Advanix Pancreatic Stent – Straight, No Leading Barb | 27 |
| M00534730 | Advanix Center Bend Preloaded RX Stent Systems | 20 | M00536270 | Advanix Pancreatic Stent – Straight, No Leading Barb | 27 |
| M00535000 | NaviFlex™ Pancreatic Stent RX Pusher | 31 | M00536280 | Advanix Pancreatic Stent – Straight, No Leading Barb | 27 |
| M00535010 | NaviFlex Pancreatic Stent RX Pusher | 31 | M00536290 | Advanix Pancreatic Stent – Straight, No Leading Barb | 27 |
| M00535020 | NaviFlex Pancreatic Stent Pusher | 31 | M00536300 | Advanix Pancreatic Stent – Straight, No Leading Barb | 27 |
| M00535030 | NaviFlex Pancreatic Stent Pusher | 31 | M00536310 | Advanix Pancreatic Stent – Straight, No Leading Barb | 27 |
| M00535060 | NaviFlex RX Pancreatic Stent Delivery System | 31 | M00536320 | Advanix Pancreatic Stent – Straight, No Leading Barb | 27 |
| M00535080 | NaviFlex RX Pancreatic Stent Delivery System | 31 | M00536330 | Advanix Pancreatic Stent – Straight, No Leading Barb | 27 |
| M00535110 | Stonetome™ Stone Removal Device | 11 | M00536340 | Advanix Pancreatic Stent – Straight, No Leading Barb | 27 |
| M00535130 | Stonetome Stone Removal Device | 11 | M00536350 | Advanix Pancreatic Stent – Straight, No Leading Barb | 27 |
| M00535150 | Stonetome Stone Removal Device | 11 | M00536360 | Advanix Pancreatic Stent – Straight, Leading Barb | 28 |
| M00535170 | Stonetome Stone Removal Device | 11 | M00536370 | Advanix Pancreatic Stent – Straight, Leading Barb | 28 |
| M00535190 | Stonetome Stone Removal Device | 11 | M00536380 | Advanix Pancreatic Stent – Straight, Leading Barb | 28 |
| M00535210 | Stonetome Stone Removal Device | 11 | M00536390 | Advanix Pancreatic Stent – Straight, Leading Barb | 28 |
| M00535700 | Tandem™ XL Triple-Lumen ERCP Cannula – Tapered | 13 | M00536400 | Advanix Pancreatic Stent – Straight, Leading Barb | 28 |
| M00535900 | Ultratome™ XL Triple-Lumen Sphincterotome – Short Nose | 11 | M00536410 | Advanix Pancreatic Stent – Straight, Leading Barb | 28 |
| M00535910 | Ultratome XL Triple-Lumen Sphincterotome – Long Nose | 11 | M00536420 | Advanix Pancreatic Stent – Straight, Leading Barb | 28 |
| M00535920 | Ultratome XL Triple-Lumen Sphincterotome – Short Nose | 11 | M00536430 | Advanix Pancreatic Stent – Straight, Leading Barb | 28 |
| M00535930 | Ultratome XL Triple-Lumen Sphincterotome – Long Nose | 11 | M00536440 | Advanix Pancreatic Stent – Straight, Leading Barb | 28 |
| M00536000 | Advanix Pancreatic Stent – Straight, No Leading Barb | 27 | M00536450 | Advanix Pancreatic Stent – Straight, Leading Barb | 28 |
| M00536010 | Advanix Pancreatic Stent – Straight, No Leading Barb | 27 | M00536460 | Advanix Pancreatic Stent – Straight, Leading Barb | 28 |
| M00536020 | Advanix Pancreatic Stent – Straight, No Leading Barb | 27 | M00536470 | Advanix Pancreatic Stent – Straight, Leading Barb | 28 |
| M00536030 | Advanix Pancreatic Stent – Straight, No Leading Barb | 27 | M00536480 | Advanix Pancreatic Stent – Straight, Leading Barb | 28 |
| M00536040 | Advanix Pancreatic Stent – Straight, No Leading Barb | 27 | M00536490 | Advanix Pancreatic Stent – Straight, Leading Barb | 28 |
| M00536050 | Advanix Pancreatic Stent – Straight, No Leading Barb | 27 | M00536500 | Advanix Pancreatic Stent – Straight, Leading Barb | 28 |
| M00536060 | Advanix Pancreatic Stent – Straight, No Leading Barb | 27 | M00536510 | Advanix Pancreatic Stent – Straight, Leading Barb | 28 |
| M00536070 | Advanix Pancreatic Stent – Straight, No Leading Barb | 27 | M00536520 | Advanix Pancreatic Stent – Straight, Leading Barb | 28 |
| | | | M00536530 | Advanix Pancreatic Stent – Straight, Leading Barb | 28 |

Product Code Index

| Product Code | Description | Page # | Product Code | Description | Page # |
|--------------|--|--------|--------------|--|--------|
| M00537460 | Advanix™ Pancreatic Stent Kit – Straight, No Leading Barb .. | 26 | M00545050 | Ultratome™ RX Cannulating Sphincterotome – Short Nose..... | 8 |
| M00537470 | Advanix Pancreatic Stent Kit – Straight, No Leading Barb | 26 | M00545060 | Ultratome RX Cannulating Sphincterotome – Short Nose..... | 8 |
| M00537480 | Advanix Pancreatic Stent Kit – Straight, No Leading Barb | 26 | M00545150 | Autotome™ RX 49 Cannulating Sphincterotome..... | 8 |
| M00537490 | Advanix Pancreatic Stent Kit – Straight, No Leading Barb | 26 | M00545160 | Autotome RX 49 Cannulating Sphincterotome..... | 8 |
| M00537500 | Advanix Pancreatic Stent Kit – Straight, No Leading Barb | 26 | M00545170 | Autotome RX 44 Cannulating Sphincterotome..... | 8 |
| M00537510 | Advanix Pancreatic Stent Kit – Straight, No Leading Barb | 26 | M00545180 | Autotome RX 44 Cannulating Sphincterotome..... | 8 |
| M00537520 | Advanix Pancreatic Stent Kit – Straight, No Leading Barb | 26 | M00545190 | Autotome RX 39 Cannulating Sphincterotome..... | 8 |
| M00537530 | Advanix Pancreatic Stent Kit – Straight, No Leading Barb | 26 | M00545200 | Autotome RX 39 Cannulating Sphincterotome..... | 8 |
| M00537540 | Advanix Pancreatic Stent Kit – Straight, No Leading Barb | 26 | M00545211 | RX Locking Device | 14 |
| M00537550 | Advanix Pancreatic Stent Kit – Straight, No Leading Barb | 26 | M00545261 | RX Locking Device and Biopsy Cap System – Olympus™ Brand | 14 |
| M00537560 | Advanix Pancreatic Stent Kit – Straight, No Leading Barb | 26 | M00545271 | RX Locking Device and Biopsy Cap System – Pentax™ Brand | 14 |
| M00539200 | Flexima™ Duodenal Bend Biliary Stent with Delivery System..... | 23 | M00545281 | RX Locking Device and Biopsy Cap System – Fujinon™ Brand..... | 14 |
| M00539210 | Flexima Duodenal Bend Biliary Stent with Delivery System.. | 23 | M00545471 | RX Locking Device | 14 |
| M00539220 | Flexima Duodenal Bend Biliary Stent with Delivery System.. | 23 | M00545550 | RX Duodenal Bend Biliary Stent with RX Delivery System | 23 |
| M00539230 | Flexima Duodenal Bend Biliary Stent with Delivery System.. | 23 | M00545560 | RX Duodenal Bend Biliary Stent with RX Delivery System | 23 |
| M00539240 | Flexima Duodenal Bend Biliary Stent with Delivery System.. | 23 | M00545570 | RX Duodenal Bend Biliary Stent with RX Delivery System | 23 |
| M00539250 | Flexima Duodenal Bend Biliary Stent with Delivery System.. | 23 | M00545580 | RX Duodenal Bend Biliary Stent with RX Delivery System | 23 |
| M00539260 | Flexima Duodenal Bend Biliary Stent with Delivery System.. | 23 | M00545590 | RX Duodenal Bend Biliary Stent with RX Delivery System | 23 |
| M00539270 | Flexima Duodenal Bend Biliary Stent with Delivery System.. | 23 | M00545600 | RX Duodenal Bend Biliary Stent with RX Delivery System | 23 |
| M00539280 | Flexima Duodenal Bend Biliary Stent with Delivery System.. | 23 | M00545610 | RX Duodenal Bend Biliary Stent with RX Delivery System | 23 |
| M00539290 | Flexima Duodenal Bend Biliary Stent with Delivery System.. | 23 | M00545620 | RX Duodenal Bend Biliary Stent with RX Delivery System | 23 |
| M00539300 | Flexima Duodenal Bend Biliary Stent with Delivery System.. | 23 | M00545630 | RX Duodenal Bend Biliary Stent with RX Delivery System | 23 |
| M00539310 | Flexima Duodenal Bend Biliary Stent with Delivery System.. | 23 | M00545640 | RX Duodenal Bend Biliary Stent with RX Delivery System | 23 |
| M00539320 | Flexima Duodenal Bend Biliary Stent with Delivery System.... | 23 | M00545650 | RX Duodenal Bend Biliary Stent with RX Delivery System | 23 |
| M00539330 | Flexima Duodenal Bend Biliary Stent with Delivery System.. | 23 | M00545660 | RX Duodenal Bend Biliary Stent with RX Delivery System | 23 |
| M00539340 | Flexima Duodenal Bend Biliary Stent with Delivery System.. | 23 | M00545670 | RX Duodenal Bend Biliary Stent with RX Delivery System | 23 |
| M00539350 | Flexima Duodenal Bend Biliary Stent with Delivery System.. | 23 | M00545680 | RX Duodenal Bend Biliary Stent with RX Delivery System | 23 |
| M00539360 | Flexima Duodenal Bend Biliary Stent with Delivery System.. | 23 | M00545690 | RX Duodenal Bend Biliary Stent with RX Delivery System | 23 |
| M00539370 | Flexima Duodenal Bend Biliary Stent with Delivery System.. | 23 | M00545700 | RX Duodenal Bend Biliary Stent with RX Delivery System | 23 |
| M00539380 | Flexima Duodenal Bend Biliary Stent with Delivery System.. | 23 | M00545710 | RX Duodenal Bend Biliary Stent with RX Delivery System | 23 |
| M00539390 | Flexima Duodenal Bend Biliary Stent with Delivery System.. | 23 | M00545720 | RX Duodenal Bend Biliary Stent with RX Delivery System | 23 |
| M00540110 | Flexima Single Pigtail Nasobiliary Catheter..... | 25 | M00545730 | RX Duodenal Bend Biliary Stent with RX Delivery System | 23 |
| M00540120 | Flexima Single Pigtail Nasobiliary Catheter..... | 25 | M00545740 | RX Duodenal Bend Biliary Stent with RX Delivery System | 23 |
| M00540130 | Flexima Single Pigtail Nasobiliary Catheter..... | 25 | M00545760 | RX ERCP Cannula – Standard Tip..... | 12 |
| M00540140 | Flexima Single Pigtail Nasobiliary Catheter..... | 25 | M00545770 | RX ERCP Cannula – Tapered Tip..... | 12 |
| M00540200 | Endostat™ III Bipolar / Monopolar Electrosurgical Generator.. | 52 | M00545780 | RX ERCP Cannula – Ball Tip..... | 12 |
| M00540240 | Endostat Generator Accessories – Endostat III Dual Footswitch..... | 52 | M00545820 | Rapid Exchange XL Cannula | 12 |
| M00540720 | Endostat Generator Accessories – Water Bottle | 52 | M00545840 | RX Needle Knife XL Triple-Lumen Needle Knife..... | 8 |
| M00540760 | Endostat Generator Accessories – Power Cord w/ I.E.C. Molded Plug..... | 52 | M00545890 | Hurricane™ RX Biliary Balloon Dilatation Catheter..... | 35 |
| M00540771 | Endostat Generator Accessories – E-Z Load Pump Tubing – Endostat III | 52 | M00545900 | Hurricane RX Biliary Balloon Dilatation Catheter..... | 35 |
| M00542251 | Speedband Superview Super 7™ Multiple Band Ligators..... | 51 | M00545910 | Hurricane RX Biliary Balloon Dilatation Catheter..... | 35 |
| M00542253 | Speedband Superview Super 7 Multiple Band Ligators..... | 51 | M00545920 | Hurricane RX Biliary Balloon Dilatation Catheter..... | 35 |
| M00545000 | RX Cytology Brush Wireguided Cytology Brush | 36 | | | |

Product Code Index

| Product Code | Description | Page # | Product Code | Description | Page # |
|--------------|---|--------|--------------|--|--------|
| M00545930 | Hurricane™ RX Biliary Balloon Dilatation Catheter..... | 35 | M00550090 | Amplatz Super Stiff™ Guidewires – Straight Tip | 47 |
| M00545940 | Hurricane RX Biliary Balloon Dilatation Catheter..... | 35 | M00550300 | CRE™ Single-Use Pulmonary Balloon Dilator | 83 |
| M00545950 | Hurricane RX Biliary Balloon Dilatation Catheter..... | 35 | M00550310 | CRE Single-Use Pulmonary Balloon Dilator..... | 83 |
| M00545960 | Hurricane RX Biliary Balloon Dilatation Catheter..... | 35 | M00550320 | CRE Single-Use Pulmonary Balloon Dilator..... | 83 |
| M00546030 | SpyGlass™ Direct Visualization System – Probe..... | 39 | M00550330 | CRE Single-Use Pulmonary Balloon Dilator..... | 83 |
| M00546040 | SpyGlass Direct Visualization System – Ocular | 39 | M00550340 | CRE Single-Use Pulmonary Balloon Dilator..... | 83 |
| M00546050 | SpyGlass Direct Visualization System – Storage Tray, Small.. | 39 | M00550350 | CRE Single-Use Pulmonary Balloon Dilator..... | 83 |
| M00546060 | SpyGlass Direct Visualization System – Storage Tray, Large... | 39 | M00550601 | Alliance™ II Inflation System – Single-Use Syringe / Gauge Assembly | 58, 83 |
| M00546070 | SpyGlass Direct Visualization System – 3-Joint Arm with Clamp..... | 39 | M00550620 | Alliance II Inflation System – Inflation Handle..... | 58, 83 |
| M00546100 | SpyGlass Direct Visualization System – Camera | 39 | M00551591 | Pathfinder™ Exchange Guidewire – Stiff Shaft..... | 5 |
| M00546120 | SpyGlass Direct Visualization System – Video Monitor..... | 39 | M00553200 | Inflation / Deflation Devices and Accessories – Achalasia Pneumatic Hand Pump and Monitor | 58 |
| M00546140 | SpyGlass Direct Visualization System – Irrigation Pump with Foot Switch..... | 39 | M00554500 | Rigiflex™ II Single-Use Achalasia Balloon Dilators..... | 57 |
| M00546160 | SpyGlass Direct Visualization System – Travel Cart | 39 | M00554510 | Rigiflex II Single-Use Achalasia Balloon Dilators..... | 57 |
| M00546190 | SpyGlass Direct Visualization System – Lightsource | 39 | M00554520 | Rigiflex II Single-Use Achalasia Balloon Dilators..... | 57 |
| M00546200 | SpyGlass Direct Visualization System – Lightsource Replacement Bulb..... | 39 | M00555500 | Expect Slimline (SL) Endoscopic Ultrasound Aspiration Needle .. | 41 |
| M00546210 | SpyGlass Direct Visualization System – Light Cable..... | 39 | M00555510 | Expect Slimline (SL) Endoscopic Ultrasound Aspiration Needle .. | 41 |
| M00546230 | SpyScope™ Access & Delivery Catheter | 39 | M00555520 | Expect Slimline (SL) Endoscopic Ultrasound Aspiration Needle .. | 41 |
| M00546250 | SpyGlass Direct Visualization System – Power Cable Pack... | 39 | M00555530 | Expect Slimline (SL) Endoscopic Ultrasound Aspiration Needle .. | 41 |
| M00546260 | SpyGlass Direct Visualization System – Isolation Transformer (120V)..... | 39 | M00555501 | Expect Slimline (SL) Endoscopic Ultrasound Aspiration Needle .. | 41 |
| M00546270 | SpyBite™ Biopsy Forceps..... | 39 | M00555511 | Expect Slimline (SL) Endoscopic Ultrasound Aspiration Needle .. | 41 |
| M00546451 | SpyGlass Direct Visualization System – Irrigation Tube Set.. | 39 | M00555521 | Expect Slimline (SL) Endoscopic Ultrasound Aspiration Needle .. | 41 |
| M00547000 | Extractor™ Pro RX Retrieval Balloons – Distal Injection | 32 | M00555531 | Expect Slimline (SL) Endoscopic Ultrasound Aspiration Needle .. | 41 |
| M00547010 | Extractor Pro RX Retrieval Balloons – Distal Injection | 32 | M00556001 | Hydra Jagwire™ High Performance Guidewire – Straight..... | 3 |
| M00547020 | Extractor Pro RX Retrieval Balloons – Distal Injection | 32 | M00556011 | Hydra Jagwire High Performance Guidewire – Angled | 3 |
| M00547030 | Extractor Pro RX Retrieval Balloons – Proximal Injection..... | 32 | M00556021 | Hydra Jagwire High Performance Guidewire – Stiff Shaft – Straight..... | 3 |
| M00547040 | Extractor Pro RX Retrieval Balloons – Proximal Injection..... | 32 | M00556031 | Hydra Jagwire High Performance Guidewire – Stiff Shaft – Angled | 3 |
| M00547050 | Extractor Pro RX Retrieval Balloons – Proximal Injection..... | 32 | M00556041 | Hydra Jagwire High Performance Guidewire – Straight..... | 3 |
| M00547100 | Extractor Pro XL Retrieval Balloons – Distal Injection | 32 | M00556051 | Hydra Jagwire High Performance Guidewire – Angled | 3 |
| M00547110 | Extractor Pro XL Retrieval Balloons – Distal Injection | 32 | M00556061 | Hydra Jagwire High Performance Guidewire – Stiff Shaft – Straight..... | 3 |
| M00547120 | Extractor Pro XL Retrieval Balloons – Distal Injection | 32 | M00556071 | Hydra Jagwire High Performance Guidewire – Stiff Shaft – Angled | 3 |
| M00547130 | Extractor Pro XL Retrieval Balloons – Proximal Injection..... | 32 | M00556101 | Dreamwire™ High Performance Guidewire – Standard Shaft .. | 3 |
| M00547140 | Extractor Pro XL Retrieval Balloons – Proximal Injection..... | 32 | M00556111 | Dreamwire High Performance Guidewire – Standard Shaft ... | 3 |
| M00547150 | Extractor Pro XL Retrieval Balloons – Proximal Injection..... | 32 | M00556121 | Dreamwire High Performance Guidewire – Stiff Shaft..... | 3 |
| M00547200 | Extractor Pro DL Retrieval Balloons..... | 33 | M00556131 | Dreamwire High Performance Guidewire – Stiff Shaft..... | 3 |
| M00547210 | Extractor Pro DL Retrieval Balloons..... | 33 | M00556141 | Dreamwire High Performance Guidewire – Standard Shaft.... | 3 |
| M00547220 | Extractor Pro DL Retrieval Balloons..... | 33 | M00556151 | Dreamwire High Performance Guidewire – Standard Shaft ... | 3 |
| M00550000 | Expect™ Endoscopic Ultrasound Aspiration Needle | 41 | M00556161 | Dreamwire High Performance Guidewire – Stiff Shaft..... | 3 |
| M00550001 | Expect Endoscopic Ultrasound Aspiration Needle | 41 | M00556171 | Dreamwire High Performance Guidewire – Stiff Shaft..... | 3 |
| M00550010 | Expect Endoscopic Ultrasound Aspiration Needle | 41 | M00556181 | NaviPro™ Hydrophilic Guidewire..... | 5 |
| M00550011 | Expect Endoscopic Ultrasound Aspiration Needle | 41 | M00556191 | NaviPro Hydrophilic Guidewire..... | 5 |
| M00550020 | Expect Endoscopic Ultrasound Aspiration Needle | 41 | M00556201 | NaviPro Hydrophilic Guidewire..... | 5 |
| M00550021 | Expect Endoscopic Ultrasound Aspiration Needle | 41 | M00556211 | NaviPro Hydrophilic Guidewire..... | 5 |
| M00550040 | Expect Endoscopic Ultrasound Aspiration Needle | 41 | | | |
| M00550041 | Expect Endoscopic Ultrasound Aspiration Needle | 41 | | | |

Product Code Index

| Product Code | Description | Page # | Product Code | Description | Page # |
|--------------|---|--------|--------------|--|--------|
| M00556221 | NaviPro™ Hydrophilic Guidewire..... | 5 | M00558420 | CRE Single-Use Wireguided Esophageal / Pyloric Balloon Dilators..... | 59 |
| M00556231 | NaviPro Hydrophilic Guidewire..... | 5 | M00558430 | CRE Single-Use Wireguided Esophageal / Pyloric Balloon Dilators..... | 59 |
| M00556241 | NaviPro Hydrophilic Guidewire..... | 5 | M00558440 | CRE Single-Use Wireguided Esophageal / Pyloric Balloon Dilators..... | 59 |
| M00556251 | NaviPro Hydrophilic Guidewire..... | 5 | M00558450 | CRE Single-Use Wireguided Esophageal / Pyloric / Colonic Balloon Dilators..... | 59 |
| M00556461 | Jagwire™ High Performance Guidewire – Straight..... | 4 | M00558460 | CRE Single-Use Wireguided Esophageal / Pyloric / Colonic Balloon Dilators..... | 59 |
| M00556481 | Stiff Shaft Jagwire Guidewire – Straight..... | 4 | M00558470 | CRE Single-Use Wireguided Esophageal / Pyloric / Colonic Balloon Dilators..... | 59 |
| M00556491 | Stiff Shaft Jagwire Guidewire – Angled..... | 4 | M00558480 | CRE Single-Use Wireguided Esophageal / Pyloric / Colonic Balloon Dilators..... | 59 |
| M00556511 | Jagwire High Performance Guidewire – Stiff Shaft – Angled... 4 | 4 | M00558490 | CRE Single-Use Wireguided Esophageal / Pyloric / Colonic Balloon Dilators..... | 59 |
| M00556521 | Jagwire High Performance Guidewire – Stiff Shaft – Straight... 4 | 4 | M00558500 | CRE Single-Use Wireguided Esophageal / Pyloric / Colonic Balloon Dilators..... | 59 |
| M00556531 | Jagwire High Performance Guidewire – Stiff Shaft – Angled... 4 | 4 | M00558600 | CRE Single-Use Wireguided Biliary Balloon Dilators..... | 34 |
| M00556561 | Jagwire High Performance Guidewire – Stiff Shaft – Straight... 4 | 4 | | CRE Single-Use Wireguided Esophageal / Pyloric / Biliary Balloon Dilators..... | 55 |
| M00556581 | Jagwire High Performance Guidewire – Stiff Shaft – Straight... 4 | 4 | M00558610 | CRE Single-Use Wireguided Biliary Balloon Dilators..... | 34 |
| M00556591 | Jagwire High Performance Guidewire – Stiff Shaft – Angled... 4 | 4 | | CRE Single-Use Wireguided Esophageal / Pyloric / Biliary Balloon Dilators..... | 55 |
| M00556601 | Jagwire High Performance Guidewire – Stiff Shaft – Straight..... | 4 | M00558620 | CRE Single-Use Wireguided Biliary Balloon Dilators..... | 34 |
| M00556611 | Jagwire High Performance Guidewire – Stiff Shaft – Angled..... | 4 | | CRE Single-Use Wireguided Esophageal / Pyloric / Biliary Balloon Dilators..... | 55 |
| M00556621 | Jagwire High Performance Guidewire – Straight..... | 4 | M00558630 | CRE Single-Use Wireguided Biliary Balloon Dilators..... | 34 |
| M00556631 | Jagwire High Performance Guidewire – Stiff Shaft – Straight..... | 4 | | CRE Single-Use Wireguided Esophageal / Pyloric / Biliary Balloon Dilators..... | 55 |
| M00556641 | Jagwire High Performance Guidewire – Straight..... | 4 | M00558640 | CRE Single-Use Wireguided Biliary Balloon Dilators..... | 34 |
| M00556651 | Jagwire High Performance Guidewire – Angled..... | 4 | | CRE Single-Use Wireguided Esophageal / Pyloric / Biliary Balloon Dilators..... | 55 |
| M00556661 | Jagwire High Performance Guidewire – Stiff Shaft – Angled..... | 4 | M00558650 | CRE Single-Use Wireguided Biliary Balloon Dilators..... | 34 |
| M00556841 | Jagwire Extendable High Performance Guidewire – Straight... 4 | 4 | | CRE Single-Use Wireguided Esophageal / Pyloric / Biliary Balloon Dilators..... | 55 |
| M00556851 | Jagwire Extendable High Performance Guidewire – Angled.... 4 | 4 | M00558660 | CRE Single-Use Wireguided Biliary Balloon Dilators..... | 34 |
| M00556861 | Jagwire Extendable High Performance Guidewire – Stiff Shaft – Straight..... | 4 | | CRE Single-Use Wireguided Esophageal / Pyloric / Colonic / Biliary Balloon Dilators..... | 56 |
| M00556871 | Jagwire Extendable High Performance Guidewire – Stiff Shaft – Angled..... | 4 | M00558670 | CRE Single-Use Wireguided Biliary Balloon Dilators..... | 34 |
| M00556902 | Jagtail™ High Performance Guidewire Extension..... | 4 | | CRE Single-Use Wireguided Esophageal / Pyloric / Colonic / Biliary Balloon Dilators..... | 56 |
| M00557330 | Ultraflex™ Precision Single-Use Colonic Stent System..... | 44 | M00558680 | CRE Single-Use Wireguided Biliary Balloon Dilators..... | 34 |
| M00557360 | Ultraflex Precision Single-Use Colonic Stent System..... | 44 | | CRE Single-Use Wireguided Esophageal / Pyloric / Colonic / Biliary Balloon Dilators..... | 56 |
| M00557380 | Ultraflex Precision Single-Use Colonic Stent System..... | 44 | M00558690 | CRE Single-Use Wireguided Biliary Balloon Dilators..... | 34 |
| M00558330 | CRE™ Single-Use Fixed Wire Esophageal Balloon Dilators.... | 55 | | CRE Single-Use Wireguided Esophageal / Pyloric / Colonic / Biliary Balloon Dilators..... | 56 |
| M00558340 | CRE Single-Use Fixed Wire Esophageal Balloon Dilators..... | 55 | M00558700 | CRE Single-Use Wireguided Biliary Balloon Dilators..... | 34 |
| M00558350 | CRE Single-Use Fixed Wire Esophageal Balloon Dilators..... | 55 | | CRE Single-Use Wireguided Esophageal / Pyloric / Colonic / Biliary Balloon Dilators..... | 56 |
| M00558360 | CRE Single-Use Fixed Wire Esophageal Balloon Dilators..... | 55 | M00558710 | CRE Single-Use Wireguided Biliary Balloon Dilators..... | 34 |
| M00558361 | CRE Single-Use Fixed Wire Esophageal Balloon Dilators..... | 55 | | CRE Single-Use Wireguided Esophageal / Pyloric / Colonic / Biliary Balloon Dilators..... | 56 |
| M00558370 | CRE Single-Use Fixed Wire Esophageal Balloon Dilators..... | 55 | | | |
| M00558371 | CRE Single-Use Fixed Wire Esophageal Balloon Dilators..... | 55 | | | |
| M00558380 | CRE Single-Use Fixed Wire Esophageal Balloon Dilators..... | 55 | | | |
| M00558381 | CRE Single-Use Fixed Wire Esophageal Balloon Dilators..... | 55 | | | |
| M00558390 | CRE Single-Use Wireguided Esophageal / Pyloric Balloon Dilators..... | 59 | | | |
| M00558400 | CRE Single-Use Wireguided Esophageal / Pyloric Balloon Dilators..... | 59 | | | |
| M00558410 | CRE Single-Use Wireguided Esophageal / Pyloric Balloon Dilators..... | 59 | | | |

Product Code Index

| Product Code | Description | Page # | Product Code | Description | Page # |
|--------------|---|--------|--------------|---|--------|
| M00560070 | Gold Probe™ Single-Use Electrohemostasis Catheters – Standard Plug | 49 | M00561821 | Single-Use Rotatable Snares – Small Oval | 71 |
| M00560071 | Gold Probe Single-Use Electrohemostasis Catheters – Standard Plug | 49 | M00561831 | Single-Use Rotatable Snares – Medium Oval | 71 |
| M00560100 | Gold Probe Single-Use Electrohemostasis Catheters – Standard Plug | 49 | M00562301 | Captivator Single-Use Snares – Small Oval | 72 |
| M00560101 | Gold Probe Single-Use Electrohemostasis Catheters – Standard Plug | 49 | M00562321 | Captivator Single-Use Snares – Medium Oval | 72 |
| M00560150 | Injection Gold Probe™ Single-Use Electrohemostasis / Injection Catheters – Standard Plug | 49 | M00562341 | Captivator Single-Use Snares – Medium Hexagonal | 72 |
| M00560160 | Injection Gold Probe Single-Use Electrohemostasis / Injection Catheters – Standard Plug | 49 | M00562371 | Captivator Single-Use Snares – Medium Crescent | 72 |
| M00560220 | Gold Probe Single-Use Electrohemostasis Catheters – Standard Plug | 49 | M00562391 | Captivator Single-Use Snares – Large Oval | 72 |
| M00560311 | Sensation™ Single-Use Medium Stiff Wire Short Throw Snares – Medium Oval | 71 | M00562401 | Captiflex™ Single-Use Snares – Medium Oval | 72 |
| M00560321 | Sensation Single-Use Medium Stiff Wire Short Throw Snares – Small Oval | 71 | M00562402 | Captiflex Single-Use Snares – Medium Oval | 72 |
| M00560331 | Sensation Single-Use Medium Stiff Wire Short Throw Snares – Medium Crescent | 71 | M00562421 | Captiflex Single-Use Snares – Small Oval | 72 |
| M00561191 | Captivator™ II Single-Use Snares – Rounded Stiff | 73 | M00562422 | Captiflex Single-Use Snares – Small Oval | 72 |
| M00561192 | Captivator II Single-Use Snares – Rounded Stiff | 73 | M00562451 | Captivator Single-Use Snares – Small Hexagonal | 72 |
| M00561193 | Captivator II Single-Use Snares – Rounded Stiff | 73 | M00562471 | Captiflex Single-Use Snares – Extra Small Oval | 72 |
| M00561221 | Captivator II Single-Use Snares – Rounded Stiff | 73 | M00562531 | Profile™ Single-Use Snares – Extra Small Oval | 74 |
| M00561222 | Captivator II Single-Use Snares – Rounded Stiff | 73 | M00562551 | Profile Single-Use Snares – Small Oval | 74 |
| M00561223 | Captivator II Single-Use Snares – Rounded Stiff | 73 | M00562571 | Profile Single-Use Snares – Medium Oval | 74 |
| M00561231 | Captivator II Single-Use Snares – Rounded Stiff | 73 | M00562651 | Sensation Single-Use Short Throw Snares – Large Oval / Medium Stiff | 71 |
| M00561232 | Captivator II Single-Use Snares – Rounded Stiff | 73 | M00562652 | Sensation Single-Use Short Throw Snares – Large Oval / Medium Stiff | 71 |
| M00561233 | Captivator II Single-Use Snares – Rounded Stiff | 73 | M00562671 | Sensation Single-Use Short Throw Snares – Medium Oval / Flexible | 71 |
| M00561241 | Captivator II Single-Use Snares – Rounded Stiff | 73 | M00562672 | Sensation Single-Use Short Throw Snares – Medium Oval / Flexible | 71 |
| M00561242 | Captivator II Single-Use Snares – Rounded Stiff | 73 | M00562673 | Sensation Single-Use Short Throw Snares – Medium Oval / Flexible | 71 |
| M00561243 | Captivator II Single-Use Snares – Rounded Stiff | 73 | M00562691 | Sensation Single-Use Short Throw Snares – Small Oval / Flexible | 71 |
| M00561250 | Active Cords – Fits Olympus™ Brand Generator | 14, 74 | M00562692 | Sensation Single-Use Short Throw Snares – Small Oval / Flexible | 71 |
| M00561270 | Active Cord, Fits Endostat™, Endostat II and Endostat III Generators, Bovie™, Valleylab™, Aspen Labs™, and ERBE™ Brand Generators | 14, 74 | M00562693 | Sensation Single-Use Short Throw Snares – Small Oval / Flexible | 71 |
| M00561291 | Captivator II Single-Use Snare – Extra Large Rounded | 73 | M00562760 | EndoVive™ Low Profile Button | 68 |
| M00561311 | Captivator Single-Use Snares – Large Oval Medium | 72 | M00562770 | EndoVive Low Profile Button | 68 |
| M00561411 | TWISTER® PLUS Rotatable Retrieval Device | 74 | M00562780 | EndoVive Low Profile Button | 68 |
| M00561412 | TWISTER PLUS Rotatable Retrieval Device | 74 | M00562790 | EndoVive Low Profile Button | 68 |
| M00561421 | TWISTER PLUS Rotatable Retrieval Device | 74 | M00562800 | EndoVive Low Profile Button | 68 |
| M00561422 | TWISTER PLUS Rotatable Retrieval Device | 74 | M00562820 | EndoVive Low Profile Button | 68 |
| M00561440 | Electrosurgical Bipolar Cable Adapter | 53 | M00562830 | EndoVive Low Profile Button | 68 |
| M00561450 | Electrosurgical Bipolar Cable Adapter | 53 | M00562840 | EndoVive Low Profile Button | 68 |
| M00561460 | Electrosurgical Bipolar Cable Adapter | 53 | M00562850 | EndoVive Low Profile Button | 68 |
| M00561470 | Electrosurgical Bipolar Cable Adapter | 53 | M00563010 | EndoVive One-Step Button™ – Pull | 66 |
| M00561480 | Electrosurgical Bipolar Cable Adapter | 53 | M00563020 | EndoVive One-Step Button – Pull | 66 |
| M00561490 | Electrosurgical Bipolar Cable Adapter | 53 | M00563030 | EndoVive One-Step Button – Pull | 66 |
| M00561500 | Electrosurgical Bipolar Cable Adapter | 53 | M00563040 | EndoVive One-Step Button – Pull | 66 |
| | | | M00563080 | EndoVive One-Step Button – Push | 66 |
| | | | M00563090 | EndoVive One-Step Button – Push | 66 |
| | | | M00563100 | EndoVive One-Step Button – Push | 66 |

Product Code Index

| Product Code | Description | Page # | Product Code | Description | Page # |
|--------------|--|--------|--------------|--|--------|
| M00563120 | EndoVive™ One-Step Button™ – Pull | 66 | M00566350 | EndoVive Through-the-PEG (TTP) Jejunal Feeding Tube (3-Port) – Pigtail Tip | 67 |
| M00563130 | EndoVive One-Step Button – Pull | 66 | M00566461 | EndoVive Safety PEGs – Pull | 65 |
| M00563140 | EndoVive One-Step Button – Pull | 66 | M00566471 | EndoVive Safety PEGs – Push | 65 |
| M00563150 | EndoVive One-Step Button – Pull | 66 | M00566481 | EndoVive Safety PEGs – Pull | 65 |
| M00563160 | EndoVive One-Step Button – Pull | 66 | M00566491 | EndoVive Safety PEGs – Push | 65 |
| M00563180 | EndoVive One-Step Button – Push | 66 | M00566670 | Encore™ 26 Inflation Device | 36 |
| M00563190 | EndoVive One-Step Button – Push | 66 | M00567330 | MaxForce™ Biliary Balloon Dilatation Catheter | 36 |
| M00564101 | eXcelon™ Transbronchial Aspiration Needle | 81 | M00567340 | MaxForce Biliary Balloon Dilatation Catheter | 36 |
| M00564111 | eXcelon Transbronchial Aspiration Needle | 81 | M00567370 | MaxForce Biliary Balloon Dilatation Catheter | 36 |
| M00564121 | eXcelon Transbronchial Aspiration Needle | 81 | M00567380 | MaxForce Biliary Balloon Dilatation Catheter | 36 |
| M00565010 | WallFlex™ Single-Use Duodenal Stent System | 43 | M00567410 | MaxForce Biliary Balloon Dilatation Catheter | 36 |
| M00565020 | WallFlex Single-Use Duodenal Stent System | 43 | M00567420 | MaxForce Biliary Balloon Dilatation Catheter | 36 |
| M00565030 | WallFlex Single-Use Duodenal Stent System | 43 | M00568201 | EndoVive Standard PEGs – Pull | 65 |
| M00565040 | WallFlex Single-Use Colonic Stent System | 43 | M00568211 | EndoVive Standard PEGs – Push | 65 |
| M00565050 | WallFlex Single-Use Colonic Stent System | 43 | M00568241 | EndoVive Standard PEGs – Pull | 65 |
| M00565060 | WallFlex Single-Use Colonic Stent System | 43 | M00568251 | EndoVive Standard PEGs – Push | 65 |
| M00565070 | WallFlex Single-Use Colonic Stent System | 43 | M00569610 | WALLSTENT RX Biliary Endoprosthesis Stent System | 18 |
| M00565080 | WallFlex Single-Use Colonic Stent System | 43 | M00569620 | WALLSTENT RX Biliary Endoprosthesis Stent System | 18 |
| M00565090 | WallFlex Single-Use Colonic Stent System | 43 | M00569630 | WALLSTENT RX Biliary Endoprosthesis Stent System | 18 |
| M00565100 | WallFlex Single-Use Colonic Stent System | 43 | M00569640 | WALLSTENT RX Biliary Endoprosthesis Stent System | 18 |
| M00565110 | WallFlex Single-Use Colonic Stent System | 43 | M00569650 | WALLSTENT RX Biliary Endoprosthesis Stent System | 18 |
| M00565120 | WallFlex Single-Use Colonic Stent System | 43 | M00569660 | WALLSTENT RX Biliary Endoprosthesis Stent System | 18 |
| M00565130 | WallFlex Single-Use Colonic Stent System | 43 | M00569670 | WALLSTENT RX Biliary Endoprosthesis Stent System | 18 |
| M00565140 | WallFlex Single-Use Colonic Stent System | 43 | M00569680 | WALLSTENT RX Biliary Endoprosthesis Stent System | 18 |
| M00565150 | WallFlex Single-Use Colonic Stent System | 43 | M00569690 | WALLSTENT RX Biliary Endoprosthesis Stent System | 18 |
| M00565560 | WALLSTENT™ Single-Use Colonic and Duodenal Endoprosthesis with UniStep™ Plus Delivery System | 44 | M00569700 | WALLSTENT RX Biliary Endoprosthesis Stent System | 18 |
| M00565570 | WALLSTENT Single-Use Colonic and Duodenal Endoprosthesis with UniStep Plus Delivery System | 44 | M00569710 | WALLSTENT RX Biliary Endoprosthesis Stent System | 18 |
| M00565580 | WALLSTENT Single-Use Colonic and Duodenal Endoprosthesis with UniStep Plus Delivery System | 44 | M00569720 | WALLSTENT RX Biliary Endoprosthesis Stent System | 18 |
| M00565590 | WALLSTENT Single-Use Colonic and Duodenal Endoprosthesis with UniStep Plus Delivery System | 44 | M00569800 | WALLSTENT RX Biliary Endoprosthesis Stent System | 18 |
| M00565620 | WALLSTENT Single-Use Colonic and Duodenal Endoprosthesis with UniStep Plus Delivery System | 44 | M00569810 | WALLSTENT RX Biliary Endoprosthesis Stent System | 18 |
| M00565630 | WALLSTENT Single-Use Colonic and Duodenal Endoprosthesis with UniStep Plus Delivery System | 44 | M00570000 | Polyflex™ Single-Use Self-Expanding Silicone Airway Stent | 80 |
| M00565640 | WALLSTENT Single-Use Colonic and Duodenal Endoprosthesis with UniStep Plus Delivery System | 44 | M00570010 | Polyflex Single-Use Self-Expanding Silicone Airway Stent | 80 |
| M00565650 | WALLSTENT Single-Use Colonic and Duodenal Endoprosthesis with UniStep Plus Delivery System | 44 | M00570020 | Polyflex Single-Use Self-Expanding Silicone Airway Stent | 80 |
| M00566001 | RX Accessories – Rapid Refill Continuous Injection System | 14 | M00570030 | Polyflex Single-Use Self-Expanding Silicone Airway Stent | 80 |
| M00566320 | EndoVive Through-the-PEG (TTP) Jejunal Feeding Tube (3-Port) – Bent Tip | 67 | M00570040 | Polyflex Single-Use Self-Expanding Silicone Airway Stent | 80 |
| M00566330 | EndoViveThrough-the-PEG (TTP) Jejunal Feeding Tube (3-Port) – Pigtail Tip | 67 | M00570050 | Polyflex Single-Use Self-Expanding Silicone Airway Stent | 80 |
| M00566340 | EndoVive Through-the-PEG (TTP) Jejunal Feeding Tube (3-Port) – Bent Tip | 67 | M00570060 | Polyflex Single-Use Self-Expanding Silicone Airway Stent | 80 |
| | | | M00570070 | Polyflex Single-Use Self-Expanding Silicone Airway Stent | 80 |
| | | | M00570080 | Polyflex Single-Use Self-Expanding Silicone Airway Stent | 80 |
| | | | M00570090 | Polyflex Single-Use Self-Expanding Silicone Airway Stent | 80 |
| | | | M00570100 | Polyflex Single-Use Self-Expanding Silicone Airway Stent | 80 |
| | | | M00570110 | Polyflex Single-Use Self-Expanding Silicone Airway Stent | 80 |

Product Code Index

| Product Code | Description | Page # | Product Code | Description | Page # |
|--------------|--|--------|--------------|---|--------|
| M00570120 | Polyflex™ Single-Use Self-Expanding Silicone Airway Stent.. | 80 | M00573020 | Jagtome RX 49 Sphincterotome (Preloaded with Jagwire Guidewire)..... | 7 |
| M00570130 | Polyflex Single-Use Self-Expanding Silicone Airway Stent.... | 80 | M00573030 | Jagtome RX 49 Sphincterotome (Preloaded with Jagwire Guidewire)..... | 7 |
| M00570140 | Polyflex Single-Use Self-Expanding Silicone Airway Stent.... | 80 | M00573040 | Jagtome RX 44 Sphincterotome (Preloaded with Jagwire Guidewire)..... | 7 |
| M00570150 | Polyflex Single-Use Self-Expanding Silicone Airway Stent.... | 80 | M00573050 | Jagtome RX 44 Sphincterotome (Preloaded with Jagwire Guidewire)..... | 7 |
| M00570160 | Polyflex Single-Use Self-Expanding Silicone Airway Stent.... | 80 | M00573060 | Jagtome RX 44 Sphincterotome (Preloaded with Jagwire Guidewire)..... | 7 |
| M00570170 | Polyflex Single-Use Self-Expanding Silicone Airway Stent.... | 80 | M00573070 | Jagtome RX 44 Sphincterotome (Preloaded with Jagwire Guidewire)..... | 7 |
| M00570180 | Polyflex Single-Use Self-Expanding Silicone Airway Stent.... | 80 | M00573080 | Jagtome RX 39 Sphincterotome (Preloaded with Jagwire Guidewire)..... | 7 |
| M00570190 | Polyflex Single-Use Self-Expanding Silicone Airway Stent.... | 80 | M00573090 | Jagtome RX 39 Sphincterotome (Preloaded with Jagwire Guidewire)..... | 7 |
| M00570200 | Polyflex Single-Use Self-Expanding Silicone Airway Stent.... | 80 | M00573100 | Jagtome RX 39 Sphincterotome (Preloaded with Jagwire Guidewire)..... | 7 |
| M00570210 | Polyflex Single-Use Self-Expanding Silicone Airway Stent.... | 80 | M00573110 | Jagtome RX 39 Sphincterotome (Preloaded with Jagwire Guidewire)..... | 7 |
| M00570220 | Polyflex Single-Use Self-Expanding Silicone Airway Stent.... | 80 | M00576300 | Ultraflex™ Single-Use Uncovered Tracheobronchial Stent System – Distal Release | 78 |
| M00570230 | Polyflex Single-Use Self-Expanding Silicone Airway Stent.... | 80 | M00576310 | Ultraflex Single-Use Uncovered Tracheobronchial Stent System – Distal Release | 78 |
| M00570240 | Polyflex Single-Use Self-Expanding Silicone Airway Stent.... | 80 | M00576320 | Ultraflex Single-Use Uncovered Tracheobronchial Stent System – Distal Release | 78 |
| M00570250 | Polyflex Single-Use Self-Expanding Silicone Airway Stent.... | 80 | M00576330 | Ultraflex Single-Use Uncovered Tracheobronchial Stent System – Distal Release | 78 |
| M00570260 | Polyflex Single-Use Self-Expanding Silicone Airway Stent.... | 80 | M00576340 | Ultraflex Single-Use Uncovered Tracheobronchial Stent System – Distal Release | 78 |
| M00570270 | Polyflex Single-Use Self-Expanding Silicone Airway Stent.... | 80 | M00576350 | Ultraflex Single-Use Uncovered Tracheobronchial Stent System – Distal Release | 78 |
| M00570280 | Polyflex Single-Use Self-Expanding Silicone Airway Stent.... | 80 | M00576360 | Ultraflex Single-Use Uncovered Tracheobronchial Stent System – Distal Release | 78 |
| M00570290 | Polyflex Single-Use Self-Expanding Silicone Airway Stent.... | 80 | M00576370 | Ultraflex Single-Use Uncovered Tracheobronchial Stent System – Distal Release | 78 |
| M00570300 | Polyflex Single-Use Self-Expanding Silicone Airway Stent.... | 80 | M00576380 | Ultraflex Single-Use Uncovered Tracheobronchial Stent System – Distal Release | 78 |
| M00570310 | Polyflex Single-Use Self-Expanding Silicone Airway Stent.... | 80 | M00576410 | Ultraflex Single-Use Uncovered Tracheobronchial Stent System – Proximal Release..... | 78 |
| M00570320 | Polyflex Single-Use Self-Expanding Silicone Airway Stent.... | 80 | M00576420 | Ultraflex Single-Use Uncovered Tracheobronchial Stent System – Proximal Release..... | 78 |
| M00570330 | Polyflex Single-Use Self-Expanding Silicone Airway Stent.... | 80 | M00576430 | Ultraflex Single-Use Uncovered Tracheobronchial Stent System – Proximal Release..... | 78 |
| M00570500 | WallFlex™ Biliary RX Fully Covered Stent System | 17 | M00576440 | Ultraflex Single-Use Uncovered Tracheobronchial Stent System – Proximal Release..... | 78 |
| M00570510 | WallFlex Biliary RX Fully Covered Stent System..... | 17 | M00576450 | Ultraflex Single-Use Uncovered Tracheobronchial Stent System – Proximal Release..... | 78 |
| M00570520 | WallFlex Biliary RX Fully Covered Stent System | 17 | M00576460 | Ultraflex Single-Use Uncovered Tracheobronchial Stent System – Proximal Release..... | 78 |
| M00570530 | WallFlex Biliary RX Fully Covered Stent System | 17 | M00576470 | Ultraflex Single-Use Uncovered Tracheobronchial Stent System – Proximal Release..... | 78 |
| M00570540 | WallFlex Biliary RX Fully Covered Stent System | 17 | M00576480 | Ultraflex Single-Use Uncovered Tracheobronchial Stent System – Proximal Release..... | 78 |
| M00570600 | WallFlex Biliary RX Uncovered Stent System..... | 17 | | | |
| M00570610 | WallFlex Biliary RX Uncovered Stent System..... | 17 | | | |
| M00570620 | WallFlex Biliary RX Uncovered Stent System..... | 17 | | | |
| M00570630 | WallFlex Biliary RX Uncovered Stent System..... | 17 | | | |
| M00570640 | WallFlex Biliary RX Uncovered Stent System..... | 17 | | | |
| M00570650 | WallFlex Biliary RX Uncovered Stent System..... | 17 | | | |
| M00570660 | WallFlex Biliary RX Uncovered Stent System..... | 17 | | | |
| M00570670 | Dynamic™ (Y) Stent | 77 | | | |
| M00570680 | Dynamic (Y) Stent | 77 | | | |
| M00570690 | Dynamic (Y) Stent | 77 | | | |
| M00570700 | WallFlex Biliary RX Partially Covered Stent System | 17 | | | |
| M00570710 | WallFlex Biliary RX Partially Covered Stent System | 17 | | | |
| M00570720 | WallFlex Biliary RX Partially Covered Stent System | 17 | | | |
| M00570730 | WallFlex Biliary RX Partially Covered Stent System | 17 | | | |
| M00570740 | WallFlex Biliary RX Partially Covered Stent System | 17 | | | |
| M00570890 | WallFlex Biliary RX Uncovered Stent System..... | 17 | | | |
| M00573000 | Jagtome™ RX 49 Sphincterotome (Preloaded with Jagwire™ Guidewire) | 7 | | | |
| M00573010 | Jagtome RX 49 Sphincterotome (Preloaded with Jagwire Guidewire)..... | 7 | | | |

Product Code Index

| Product Code | Description | Page # | Product Code | Description | Page # |
|--------------|---|--------|--------------|--|--------|
| M00576490 | Ultraflex™ Single-Use Uncovered Tracheobronchial Stent System – Proximal Release | 78 | M00580441 | EndoVive One-Step Button and Low Profile Button Accessories – 18Fr Decompression Tube | 66, 68 |
| M00576520 | Ultraflex Single-Use Partially Covered Tracheobronchial Stent System – Distal Release | 79 | M00580461 | EndoVive One-Step Button and Low Profile Button Accessories – 24Fr Decompression Tube | 66, 68 |
| M00576530 | Ultraflex Single-Use Partially Covered Tracheobronchial Stent System – Distal Release | 79 | M00580471 | EndoVive One-Step Button and Low Profile Button Accessories – 24Fr Decompression Tube | 66, 68 |
| M00576540 | Ultraflex Single-Use Partially Covered Tracheobronchial Stent System – Distal Release | 79 | M00580481 | EndoVive One-Step Button and Low Profile Button Accessories – 24Fr Decompression Tube | 66, 68 |
| M00576550 | Ultraflex Single-Use Partially Covered Tracheobronchial Stent System – Distal Release | 79 | M00580491 | EndoVive One-Step Button and Low Profile Button Accessories – 24Fr Decompression Tube | 66, 68 |
| M00576560 | Ultraflex Single-Use Partially Covered Tracheobronchial Stent System – Distal Release | 79 | M00580641 | EndoVive Initial Placement PEG Accessories – Y-Ports | 65 |
| M00576570 | Ultraflex Single-Use Partially Covered Tracheobronchial Stent System – Distal Release | 79 | M00580651 | EndoVive Initial Placement PEG Accessories – Y-Ports | 65 |
| M00576580 | Ultraflex Single-Use Partially Covered Tracheobronchial Stent System – Distal Release | 79 | M00580731 | EndoVive Initial Placement PEG Accessories – Round Bolsters | 65 |
| M00576590 | Ultraflex Single-Use Partially Covered Tracheobronchial Stent System – Distal Release | 79 | M00580781 | EndoVive Initial Placement PEG Accessories – C Clamps | 65 |
| M00576600 | Ultraflex Single-Use Partially Covered Tracheobronchial Stent System – Distal Release | 79 | M00582040 | EndoVive Standard Balloon Replacements – Straight | 67 |
| M00576610 | Ultraflex Single-Use Partially Covered Tracheobronchial Stent System – Distal Release | 79 | M00582050 | EndoVive Standard Balloon Replacements – Straight | 67 |
| M00576620 | Ultraflex Single-Use Partially Covered Tracheobronchial Stent System – Distal Release | 79 | M00582060 | EndoVive Standard Balloon Replacements – Straight | 67 |
| M00576630 | Ultraflex Single-Use Partially Covered Tracheobronchial Stent System – Distal Release | 79 | M00582070 | EndoVive Standard Balloon Replacements – Straight | 67 |
| M00576640 | Ultraflex Single-Use Partially Covered Tracheobronchial Stent System – Distal Release | 79 | M00582080 | EndoVive Standard Balloon Replacements – Straight | 67 |
| M00576650 | Ultraflex Single-Use Partially Covered Tracheobronchial Stent System – Distal Release | 79 | M00582090 | EndoVive Standard Balloon Replacements – Straight | 67 |
| M00576660 | Ultraflex Single-Use Partially Covered Tracheobronchial Stent System – Distal Release | 79 | M00582100 | EndoVive Standard Balloon Replacements – Straight | 67 |
| M00576670 | Ultraflex Single-Use Partially Covered Tracheobronchial Stent System – Distal Release | 79 | M00582110 | EndoVive Standard Balloon Replacements – Right-Angle | 67 |
| M00576680 | Ultraflex Single-Use Partially Covered Tracheobronchial Stent System – Distal Release | 79 | M00582120 | EndoVive Standard Balloon Replacements – Right-Angle | 67 |
| M00576690 | Ultraflex Single-Use Partially Covered Tracheobronchial Stent System – Distal Release | 79 | M00582130 | EndoVive Standard Balloon Replacements – Right-Angle | 67 |
| M00580171 | EndoVive™ One-Step Button™ and Low Profile Button Accessories – 18Fr Bolus Straight Feeding Adapter | 66, 68 | M00582140 | EndoVive Standard Balloon Replacements – Right-Angle | 67 |
| M00580181 | EndoVive One-Step Button and Low Profile Button Accessories – 18Fr Continuous Right Angle Feeding Adapter | 66, 68 | M00582150 | EndoVive Standard Balloon Replacements – Right-Angle | 67 |
| M00580231 | EndoVive One-Step Button and Low Profile Button Accessories – 24Fr Bolus Straight Feeding Adapter | 66, 68 | M00582160 | EndoVive Standard Balloon Replacements – Right-Angle | 67 |
| M00580241 | EndoVive One-Step Button and Low Profile Button Accessories – 24Fr Continuous Right Angle Feeding Adapter | 66, 68 | M00582170 | EndoVive Standard Balloon Replacements – Right-Angle | 67 |
| M00580401 | EndoVive One-Step Button and Low Profile Button Accessories – 18Fr Decompression Tube | 66, 68 | M00582860 | EndoVive Standard Balloon Replacements – Straight | 67 |
| M00580411 | EndoVive One-Step Button and Low Profile Button Accessories – 18Fr Decompression Tube | 66, 68 | M00582870 | EndoVive Standard Balloon Replacements – Right-Angle | 67 |
| M00580421 | EndoVive One-Step Button and Low Profile Button Accessories – 18Fr Decompression Tube | 66, 68 | M00583000 | Hydratome™ RX 49 Sphincterotome (Preloaded with Hydra Jagwire™ Guidewire) | 6 |
| M00580431 | EndoVive One-Step Button and Low Profile Button Accessories – 18Fr Decompression Tube | 66, 68 | M00583010 | Hydratome RX 49 Sphincterotome (Preloaded with Hydra Jagwire Guidewire) | 6 |
| | | | M00583020 | Hydratome RX 49 Sphincterotome (Preloaded with Hydra Jagwire Guidewire) | 6 |
| | | | M00583030 | Hydratome RX 49 Sphincterotome (Preloaded with Hydra Jagwire Guidewire) | 6 |
| | | | M00583040 | Hydratome RX 44 Sphincterotome (Preloaded with Hydra Jagwire Guidewire) | 6 |
| | | | M00583050 | Hydratome RX 44 Sphincterotome (Preloaded with Hydra Jagwire Guidewire) | 6 |
| | | | M00583060 | Hydratome RX 44 Sphincterotome (Preloaded with Hydra Jagwire Guidewire) | 6 |
| | | | M00583070 | Hydratome RX 44 Sphincterotome (Preloaded with Hydra Jagwire Guidewire) | 6 |
| | | | M00583080 | TRUEtome™ Jag 39 Cannulating Sphincterotome (Preloaded with High Performance Jagwire™ Guidewire) | 9 |
| | | | M00583090 | TRUEtome Jag 44 Cannulating Sphincterotome (Preloaded with High Performance Jagwire Guidewire) | 9 |
| | | | M00583100 | TRUEtome Jag 44 Cannulating Sphincterotome (Preloaded with High Performance Jagwire Guidewire) | 9 |

Product Code Index

| Product Code | Description | Page # | Product Code | Description | Page # |
|--------------|---|--------|--------------|---|--------|
| M00583110 | TRUEtome™ Jag 44 Cannulating Sphincterotome (Preloaded with High Performance Jagwire™ Guidewire) | 9 | M00589140 | MaxForce TTS Esophageal High Performance Balloon Dilatation Catheter | 57 |
| M00583120 | TRUEtome Jag 39 Cannulating Sphincterotome (Preloaded with High Performance Jagwire Guidewire) | 9 | M00589150 | MaxForce TTS Esophageal High Performance Balloon Dilatation Catheter | 57 |
| M00583130 | TRUEtome Jag 44 Cannulating Sphincterotome (Preloaded with High Performance Jagwire Guidewire) | 9 | M00589160 | MaxForce TTS Esophageal High Performance Balloon Dilatation Catheter | 57 |
| M00583140 | TRUEtome Jag 44 Cannulating Sphincterotome (Preloaded with High Performance Jagwire Guidewire) | 9 | M00589180 | MaxForce TTS Esophageal High Performance Balloon Dilatation Catheter | 57 |
| M00583150 | TRUEtome Jag 44 Cannulating Sphincterotome (Preloaded with High Performance Jagwire Guidewire) | 9 | M005ATS20000 | Alair™ Bronchial Thermoplasty System Controller..... | 77 |
| M00583160 | TRUEtome Hydra 44 Cannulating Sphincterotome (Preloaded with High Performance Hydra Guidewire)..... | 9 | M005ATS25010 | Alair Bronchial Thermoplasty System Catheter | 77 |
| M00583170 | TRUEtome Hydra 44 Cannulating Sphincterotome (Preloaded with High Performance Hydra Guidewire)..... | 9 | M005ATS20110 | Alair RF Controller Accessory Kit | 77 |
| M00583180 | TRUEtome Dreamwire 44 Cannulating Sphincterotome (Preloaded with High Performance Dreamwire™ Guidewire).... | 9 | M005XXXX1 | RX Cholangiogram Kit-Preloaded – Autotome™ Sphincterotome – RX Locking Device..... | 8 |
| M00583190 | TRUEtome Dreamwire 44 Cannulating Sphincterotome (Preloaded with High Performance Dreamwire Guidewire) | 9 | M005XXXX1 | RX Cholangiogram Kits – Autotome or Ultratome™ XL Sphincterotome | 8 |
| M00583200 | TRUEtome Dreamwire 44 Cannulating Sphincterotome (Preloaded with High Performance Dreamwire Guidewire) | 9 | | | |
| M00583210 | TRUEtome Dreamwire 44 Cannulating Sphincterotome (Preloaded with High Performance Dreamwire Guidewire) | 9 | | | |
| M00584000 | Dreamtome™ RX 49 Sphincterotome (Preloaded with Dreamwire High Performance Guidewire) | 6 | | | |
| M00584010 | Dreamtome RX 49 Sphincterotome (Preloaded with Dreamwire High Performance Guidewire) | 6 | | | |
| M00584020 | Dreamtome RX 49 Sphincterotome (Preloaded with Dreamwire High Performance Guidewire) | 6 | | | |
| M00584030 | Dreamtome RX 49 Sphincterotome (Preloaded with Dreamwire High Performance Guidewire) | 6 | | | |
| M00584040 | Dreamtome RX 44 Sphincterotome (Preloaded with Dreamwire High Performance Guidewire) | 6 | | | |
| M00584050 | Dreamtome RX 44 Sphincterotome (Preloaded with Dreamwire High Performance Guidewire) | 6 | | | |
| M00584060 | Dreamtome RX 44 Sphincterotome (Preloaded with Dreamwire High Performance Guidewire) | 6 | | | |
| M00584070 | Dreamtome RX 44 Sphincterotome (Preloaded with Dreamwire High Performance Guidewire) | 6 | | | |
| M00584120 | TRUEtome 39 Sphincterotome..... | 10 | | | |
| M00584150 | TRUEtome 49 Sphincterotome..... | 10 | | | |
| M00584160 | TRUEtome 49 Sphincterotome..... | 10 | | | |
| M00584170 | TRUEtome 44 Sphincterotome..... | 10 | | | |
| M00584180 | TRUEtome 44 Sphincterotome..... | 10 | | | |
| M00584190 | TRUEtome 39 Sphincterotome..... | 10 | | | |
| M00589060 | MaxForce TTS™ Esophageal High Performance Balloon Dilatation Catheter | 57 | | | |
| M00589080 | MaxForce TTS Esophageal High Performance Balloon Dilatation Catheter | 57 | | | |
| M00589100 | MaxForce TTS Esophageal High Performance Balloon Dilatation Catheter | 57 | | | |
| M00589120 | MaxForce TTS Esophageal High Performance Balloon Dilatation Catheter | 57 | | | |

Notes and Future Product Updates



Terms & Conditions

🔍 Begins on Page 105

Certain Terms and Conditions

Ordering Information

All orders should be placed directly with Boston Scientific Endoscopy Customer Service by mail, telephone, fax or Electronic Data Interchange (EDI).

Boston Scientific Endoscopy
500 Commander Shea Blvd.
Quincy, MA 02171
(888) 272-1001 Phone
(888) 272-9444 Fax
(877) 272-3340 EDI

Please contact EDI if interested in ordering your endoscopy products via the internet.

Please note that the above address is our mailing address only.

Customer Service is available between the hours of 8:30 am and 9:30 pm (Eastern Standard Time) weekdays excluding national holidays. Our toll-free fax number, (888) 272-9444, is available at all times. In addition, technical and emergency service is available 24 hours a day, 7 days a week, call (888) 272-1001 for further instructions.

Standing Orders

Boston Scientific Endoscopy accepts standing orders on all products. This convenience provides you with scheduled shipments using a single purchase order. Contact the Customer Service Database Department at (888) 325-1060 for details.

Terms

Terms are Net 30 Days. All shipments are F.O.B. Quincy, Massachusetts. Prices are subject to change without notice.

Returned Goods

Permission to return merchandise is required for all returns and, except as provided herein, may be withheld in the sole discretion of Boston Scientific Endoscopy. This authorization must be requested by calling or writing:

Customer Service

Boston Scientific Endoscopy

500 Commander Shea Blvd.

Quincy, MA 02171

(800) 862-1284

The request for authorization must include:

- Reason for the return – “Ordered in Error,” “Shipped in Error,” etc.
- Catalog number, size, quantity, lot number
- Purchase order number, Boston Scientific Endoscopy invoice number and date of invoice

All merchandise returned to Boston Scientific Endoscopy must be accompanied by a copy of the packing slip or invoice enclosed with the original shipment. The Returned Goods Authorization (RGA) number must be clearly marked on the shipping container. Merchandise returned without an RGA number will not be accepted or considered as returned product.

Merchandise that will not be accepted for return:

- Expired product or products with less than 6 months shelf life
- Merchandise manufactured as SPECIALS or CUSTOM
- Merchandise in unsaleable condition (opened, damaged, tampered, etc.)
- Merchandise not listed in this Price List or any Supplement
- Merchandise sterilized or used by customer
- Merchandise that is not packaged properly for shipping when returned
- Incomplete kits or boxes (unless defective)
- Unauthorized returns



Certain Terms and Conditions

Returned Goods (continued)

Allowance Schedule for Authorized Returns:

Allowance Schedule for Capital Equipment:

- Capital Equipment processed in error by Boston Scientific Endoscopy will receive full credit if returned in saleable condition
- Capital Equipment cannot be returned once the customer has taken title of the equipment

Allowance Schedule for Metal and Polyflex™ Stents and Alair™ Bronchial Thermoplasty Products:

- Merchandise processed in error by Boston Scientific Endoscopy will receive full credit if returned in saleable condition
- Merchandise returned within 30 days of invoice date in saleable condition will receive 100% credit
- Merchandise returned from 31 days to 90 days in saleable condition will receive full credit less a 30% restocking charge
- Merchandise returned from 91 days to 150 days in saleable condition will receive full credit less a 50% restocking fee
- Merchandise returned past 150 days will not receive any credit

Allowance Schedule for All Other Products:

- Merchandise processed in error by Boston Scientific Endoscopy will receive full credit if returned in saleable condition
- Other merchandise returned within 30 days of invoice date in saleable condition will receive full credit less a 15% restocking charge
- Merchandise returned past 31 days in saleable condition will receive full credit less a 40% restocking charge provided there is at least 6 months left on the expiration date

Pricing and Specification Changes

As we are continually introducing products and improving our existing products, this Price List does not purport to be complete, and the equipment supplied may not agree in all details with the description and specifications shown in the catalog and / or price list. All product offerings, prices and specifications are subject to change without notice.

Notice

Indications, contraindications and instructions for use, as well as product warranty information, if applicable, can be found in the product labeling supplied with each device. Federal (U.S.) law restricts this device to sale by or on the order of a physician.

Warning Re: Single-Use Devices

Products marked as “single-use” are for single use only. Do not reuse, reprocess or resterilize single-use products. Reuse, reprocessing or resterilization may compromise the structural integrity of the device and / or lead to device failure which in turn may result in patient injury, illness or death. Reuse, reprocessing or resterilization may also create a risk of contamination of the device and / or cause patient infection or cross-infection, including, but not limited to, the transmission of infectious disease(s) from one patient to another. Contamination of the device may lead to injury, illness or death of the patient. **BSC assumes no liability with respect to single-use devices reused, reprocessed or resterilized and makes no warranties, express or implied, including, but not limited to, any implied warranties of merchantability or fitness for a particular purpose, with respect to any such instrument.**

©2014 Boston Scientific Corporation or its Affiliates. All rights reserved.



Customer Ordering Information

| Universal Product Number | | |
|--|----------------|------------------------|
| Radial Jaw™ 3 Single-Use Max Capacity Biopsy F | | |
| Order Number | GTIN | Description |
| M005 1586 1 | 08714729096092 | Radial Jaw 3 Max Capac |
| M005 1587 1 | 08714729085799 | Radial Jaw 3 Max Capac |
| M005 1588 1 | 08714729085805 | Radial Jaw 3 Max Capac |
| M005 1589 1 | 08714729096108 | Radial Jaw 3 Max Capac |
| M005 1589 2 | 08714729718802 | Radial Jaw 3 Max Capac |



Bold type
is old order
number

For customer convenience, the Boston Scientific Endoscopy ordering system accepts the UPN (Universal Product Number) e.g., **M00515892** found on product labeling as well as Boston Scientific's old 4 digit order numbers e.g., **1589**.

Please use either one of these numbers when placing an order via phone, fax, internet, or Electronic Data Interchange (EDI).

For those customers who scan product today, Boston Scientific is moving to the GS1 GTIN barcode and labeling standards as part of our ongoing commitment to improve supply chain efficiency. For more information go to the website: www.bostonscientific.com/GS1.

Boston Scientific Endoscopy Customer Service Representatives will be happy to help you with any questions. We are eager to make the ordering procedure as simple and efficient as possible.

All trademarks are the property of their respective owners.

TWISTER® PLUS is a trademark of Horizons International Corp. Distributed by Boston Scientific Corporation, Marlborough, Massachusetts; manufactured by Horizons International Corp., Heredia, Costa Rica.





**Magnetic Resonance
Conditional¹**

¹Product with this symbol may be used in Magnetic Resonance environment according to the conditions described in Directions for Use.

Indications, Contraindications, Warnings and Instructions for Use can be found in the product labeling supplied with each device.
CAUTION: Federal (USA) law restricts this device to sale by or on the order of a physician.

**Boston
Scientific**
Advancing science for life™

Boston Scientific Corporation
300 Boston Scientific Way
Marlborough, MA 01752-1234
[www.bostonscientific.com/en-US/
medical-specialties/gastroenterology.html](http://www.bostonscientific.com/en-US/medical-specialties/gastroenterology.html)

Ordering Information
1.888.272.1001

©2014 Boston Scientific Corporation
or its affiliates. All rights reserved.

ENDO-278604-AA December 2014