

Crossing Every Lesion

Peripheral Vascular Interventions

**Boston
Scientific**

Advancing science for life™

OffRoad™

Re-entry Catheter System

TruePath™
CTO Device

MASTER THE CROSS

Rubicon™

Support Catheters

0.035" • 0.018" • 0.014"

Victory™

Guidewires

Tip Loads 12 • 18 • 25 • 30 grams

V-14™ & V-18™

ControlWire™ Guidewires

Tip Loads V-14™ 3 • 6 grams

V-18™ 6 • 8 grams

*0.035" = 0.89mm • 0.018" = 0.46mm • 0.014" = 0.36mm



Troubleshooting

Wire fails to select side branch



Steerability

- Increase wire torque response
- Add a torque device
- Add a torquable diagnostic catheter



Push

- Increase Wire Rail Support



Friction

- Increase Lubricity
- Increase Catheter lubricity

Tip enters lesion but wire fails to follow + Wire body curves and buckles

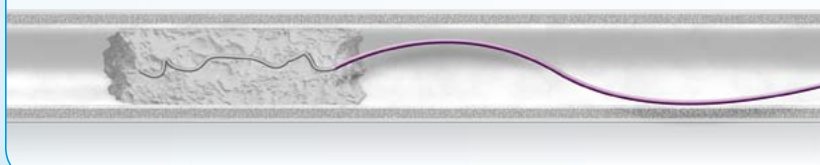

Friction

- Increase Lubricity
- Decrease Diameter

and or



Push

- Increase Wire Rail Support
- Increase Wire Support by adding a Support Catheter

Tip fails to enter lesion – Wire tip buckles against lesion

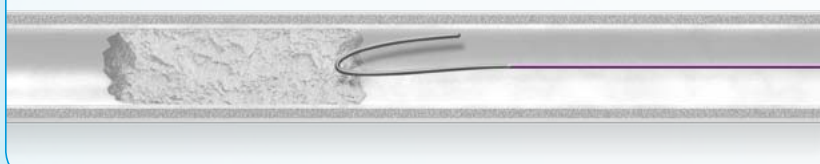

Penetrating power

- Increase Tip Load
- Decrease Wire Tip Diameter
- Focus tip force by adding a support Catheter

or

Exchange for a Crossing Device

- Mechanically breakthrough the lesion

Wire enters Subintimal space but fails to re enter true lumen

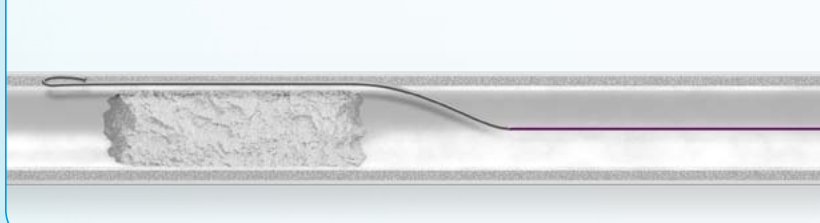

and

Change Support to the wire tip

Change catheter shape will provide backup support

and

Try different wire types

Smaller wires, stiffer tips, different torque control

or

Use a Re entry device

To provide direction and to puncture back into the true lumen allowing wire to re enter

Wire Crosses but device fails to cross

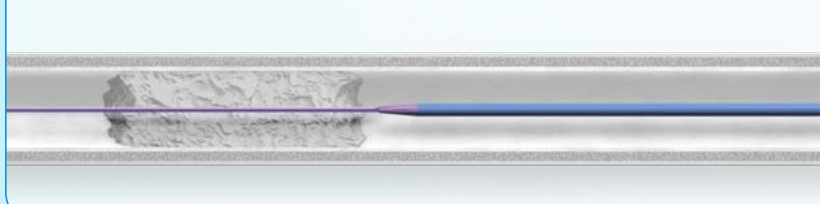

Profile

- Smaller Wire Platform
- Lower profile devices

and or



Support

- Increase Wire Rail Support
- Increase Wire Support by adding a Guiding Catheter

Wire Prolapses on entry or Flips out on Device Delivery

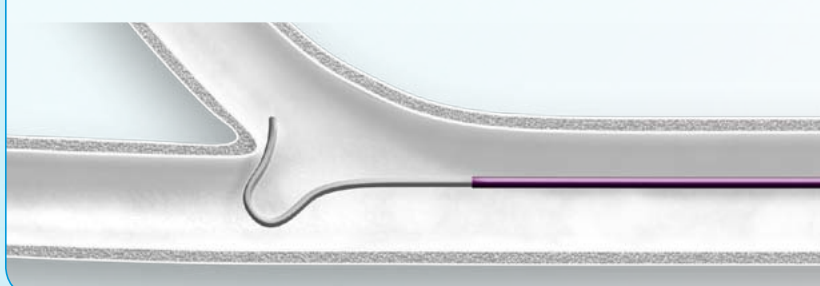

Change the Taper Length ...

... For Navigation

Increase Taper length, **longer tapers** allow the wire to follow the tip minimising prolapse

... For Device Delivery

Decrease Taper length, **shorter tapers** supports the device closer to the tip of the wire minimising "flip out" particularly in areas of short distal wire purchase

Table of Contents

0.035" (0.89 mm) +/- Guidewires

PTFE-Coated Starter™ Guidewire	6
Magic Torque™ Glidex™ Coated Hydrophilic Guidewire	7
ZIPWire™ Hydrophilic Guidewire	8
Back-up Meier™ Steerable Guidewire	9
Amplatz Super Stiff™ Guidewire	9
Platinum Plus™ Guidewire ST	9

0.018" (0.46 mm) Guidewires

Thruway™ Peripheral Guidewire	10
V-18™ ControlWire™ Guidewire with ICE™ Hydrophilic Coating	10
Victory™ Guidewire	11
ZIPWire™ Hydrophilic Guidewire	11
Platinum Plus™ Guidewire	11

0.014" (0.36 mm) Guidewires

Journey™ Peripheral Guidewire	12
Thruway™ Peripheral Guidewire	12
V-14™ ControlWire™ Guidewire with ICE™ Hydrophilic Coating	13
Victory™ Guidewire	13
Platinum Plus™ Guidewire with Glidex™ Hydrophilic Coating	13

Support Catheters

Rubicon™ Support Catheters	14
---	----

CTO Devices

TruePath™ CTO Device	16
OffRoad™ Re-entry Catheter System.....	17

Peripheral Guidewires

THE MOST COMPREHENSIVE SELECTION TO HELP YOU ACCESS, CROSS AND DELIVER

ACCESS GUIDEWIRES

Designed to be flexible, have a soft atraumatic tip, and provide enough support to deliver diagnostic devices

NAVIGATING GUIDEWIRES

Designed to be flexible, steerable and navigate tortuous anatomy

CROSSING GUIDEWIRES



Designed to provide increasing tip stiffness and excellent torque response to successfully cross lesions

DELIVERY SUPPORT GUIDEWIRES

Designed to provide additional support for delivery of large devices and may aid in vessel straightening

GUIDEWIRE NAME	TIP LOAD (GRAMS)	RAIL SUPPORT	LUBRICITY	WIRE LENGTH (CM)	TIP STYLE	TIP SHAPE:			CORE:			DISTAL COATING:		DESCRIPTIONS
						STRAIGHT	ANGLED	ATRAUMATIC	NITINOL	STAINLESS STEEL	HYDROPHILIC	SILICONE	PTEF	

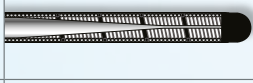
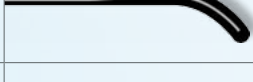

0.035" (0.89 mm) +/- Guidewires

Access	Starter™			Moderate	Low	40/80/100/ 125/150/ 180/260	Spring Coil	•		J	•			•	Standard diagnostic and access guidewire available in Fixed Core, Moveable Core, Bentson, Newton and Rosen
Navigating	Magic Torque™			Moderate	High	180 260	Spring Coil	•			•	•			Moderate access wire for catheter placement and exchange
Crossing	ZIPWire™ Standard and Stiff ^{1,2}			Moderate	High	80 150 180 260	Nitinol	•	•	J	•		•		Hydrophilic guidewire for access and crossing
Delivery Support	Amplatz Super Stiff™			Extra Support	Low	75 145 180 260	Spring Coil	•		J	•			•	Extra stiff access wire for strength and stability during catheter placement and exchange, ideal for contralateral access and carotid procedures
	Back-up Meier™			Super	Low	185 300	Spring Coil			J C	•			•	Super stiff access wire for strength and stability placing large devices such as thoracic sheaths, and AAA procedures

0.018" (0.46 mm) Guidewires

Navigating	Thruway™		2 (short taper) 4 (long taper)	Extra Support	Moderate	130 190 300	Spring Coil	•		J	•		•		Access and crossing lesions within acutely angled vessels, such as Renal arteries
Crossing	V-18™ ControlWire™ ²		6 (long taper) 8 (short taper)	Moderate	High	110 150 200 300	Polymer Sleeve	•			•	•			Crossing stenosed lesions / ideal for step-up strategy combined with higher gram load wires
	ZIPWire™ Small Vessel ^{1,2}		8	Moderate	High	150 180	Nitinol	•	•		•		•		Hydrophilic guidewire for access and crossing
	Victory™ 18 ¹		12 18 25 30	Moderate	High	195 300	Polymer Sleeve	•			•	•			Dedicated guidewires for Intraluminal technique to cross calcified lesions or tight plaque or chronic total occlusions
Delivery Support	Platinum Plus™		4 (short taper) 5 (long taper)	Extra Support	Moderate	145 180 260	Spring Coil	•			•			•	Crossing stenosed lesions / extra support for device delivery

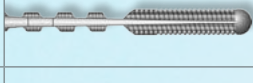
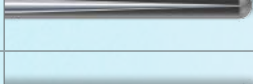
0.014" (0.36 mm) Guidewires

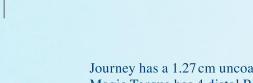
Navigating	Journey™		1.3	Light	High	185 300	Micro-cut Nitinol Sleeve	•	•		•	•			Navigating highly tortuous, distal and difficult-to-access anatomy
	Thruway™		1.3 (short taper) 1.4 (extra long taper) 1.7 (long taper)	Extra Support	Moderate	130 190 300	Spring Coil	•		J	•		•		Access and crossing lesions within acutely angled vessels, such as Renal arteries
Crossing	V-14™ ControlWire™ ²		6 (short taper) 3 (long taper)	Moderate Extra Support	High	182 300	Polymer Sleeve	•	•		•	•			Crossing stenosed lesions / ideal for step-up strategy combined with higher gram load wires
	Victory™ 14 ¹		12 18 25 30	Moderate	High	195 300	Polymer Sleeve	•			•	•			Dedicated guidewires for Intraluminal technique to cross calcified lesions or tight plaque or chronic total occlusions
Delivery Support	Platinum Plus™		7	Extra Support	Moderate	180 300	Spring Coil	•			•	•			Crossing stenosed lesions / extra support for device delivery

* Shapeable tip
** Hybrid Wire (SS and Nitinol)

¹ Starter, ZIPWire, Thruway, Victory, are trademarks owned by Lake Region Medical, USA

² This product could be also used for subintimal approach

Journey has a 1.27cm uncoated distal tip
Magic Torque has 4 distal RO markers
Thruway 0.014" (0.36 mm) has 3 distal RO markers
Platinum Plus is also available in 0.025" (0.64mm) diameter
ZIPWire is also available in 0.025" (0.64mm) and 0.038" (0.97 mm) diameters
Amplatz Super Stiff and Starter are also available in 0.038" (0.97mm) diameters

Tip load

Lubricity

Rail Support

CLINICAL RELEVANCE

Relates to stiffness of the tip. Tip stiffness relates to tip prolapse-ability and lesion cross-ability.

Relates to frictional resistance felt between the surface of the wire and the vasculature as the wire is tracked in the anatomy.

Relates to ability of the wire to support device delivery.



PTFE-coated Starter™ Access

Guidewire – Fixed Core^b

- For selective catheterization and all diagnostic and interventional procedures

UPN – Catalog Number	Diameter (in) (mm)		Length (cm)	Tip Taper (cm)	Tip Shape
M001492001	0.018	0.46	150	3	Straight
M001492011	0.025	0.64	40	3	Straight
M001492031	0.025	0.64	125	3	Straight
M001491001	0.025	0.64	150	3	Straight
M001492051	0.028	0.71	40	3	Straight
M001492081	0.032	0.81	150	4	Straight
M001492091	0.035	0.89	40	4	Straight
M001492311	0.035	0.89	80	4	Straight
M001492101	0.035	0.89	100	4	Straight
M001492111	0.035	0.89	125	4	Straight
M001491011	0.035	0.89	150	4	Straight
M001492121 ^c	0.035	0.89	180	4	Straight
M001491031 ^c	0.035	0.89	260	4	Straight
M001491021	0.038	0.97	150	4	Straight
M001492131 ^c	0.038	0.97	260	4	Straight

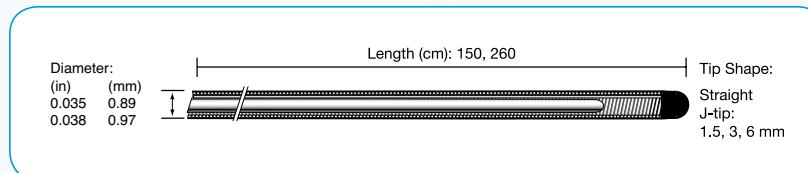
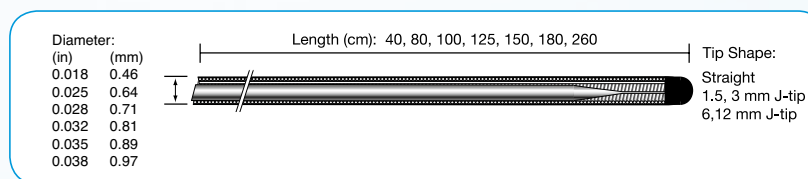

J-Curved Fixed Core^b

UPN – Catalog Number	Diameter (in) (mm)		Length (cm)	Tip Taper (cm)	Tip Shape
M001491161	0.025	0.64	150	3	3mm J
M001492211	0.032	0.81	150	11	3mm J
M001491151	0.035	0.89	150	4	1.5mm J
M001492221	0.035	0.89	40	8	3mm J
M001492301	0.035	0.89	80	10	3mm J
M001492231	0.035	0.89	100	8	3mm J
M001491171	0.035	0.89	125	10	3mm J
M001491181	0.035	0.89	150	10	3mm J
M001491201 ^c	0.035	0.89	180	10	3mm J
M001491211 ^c	0.035	0.89	260	10	3mm J
M001492251	0.035	0.89	150	9	6mm J
M001492261 ^c	0.035	0.89	180	9	6mm J
M001492271	0.035	0.89	150	8	12mm J
M001491191	0.038	0.97	150	11	3mm J
M001492281	0.038	0.97	150	8	12mm J

PTFE-coated Starter™ Access

Guidewire – Newton^a

- For access in tortuous and highly diseased vessels and smooth advancement during peripheral interventions^{*b}

UPN – Catalog Number	Diameter (in) (mm)		Length (cm)	Tip Taper (cm)	Tip Shape
M001491501	0.035	0.89	150	10	Straight
M001491511	0.035	0.89	150	15	Straight

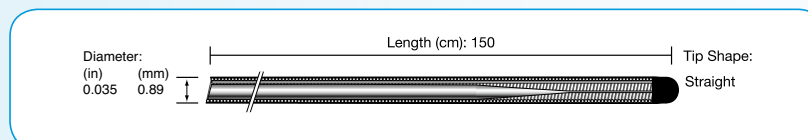

PTFE-coated Starter™ Access

Guidewire – New Bentson™^b

- For smooth advancement during peripheral intervention and for all extremely delicate diagnostic and interventional procedures^{*}

UPN – Catalog Number	Diameter (in) (mm)		Length (cm)	Tip Taper (cm)	Tip Shape
M001491451 ^b	0.035	0.89	150	15	Straight
M001491471 ^c	0.035	0.89	180	15	Straight

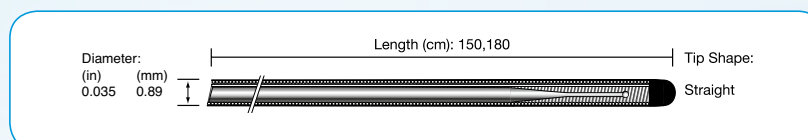

a Packaged 10/box
 b Packaged 10/box for lengths up to 150cm included.
 c Packaged 5/box for lengths up to 150cm included.
 d Packaged 3/box

* Data on file at Boston Scientific.

0.035" (0.89 mm) +/-

0.018" (0.46 mm)

0.014" (0.36 mm)

Support Catheters

CTO Devices



PTFE-coated Starter™ Access

Guidewire – Heavy Duty Fixed Core^a

UPN – Catalog Number	Diameter (in) (mm)		Length (cm)	Tip Taper (cm)	Tip Shape
M001492501	0.035	0.89	150	3	Straight

PTFEcoated Starter™ Access

Guidewire – Moveable Core

- Offering varying tip flexibility for tortuous vessels and all diagnostic and interventional procedures

UPN – Catalog Number	Diameter (in) (mm)		Length (cm)	Tip Taper (cm)	Tip Shape
M001491101 ^a	0.035	0.89	150	0	Straight
M001491111 ^a	0.038	0.97	150	0	Straight

UPN – Catalog Number	Diameter (in) (mm)		Length (cm)	Tip Taper (cm)	Tip Shape
M001491301 ^b	0.035	0.89	150	0	1.5 mm J
M001491321 ^b	0.035	0.89	150	0	3 mm J
M001491351 ^b	0.035	0.89	150	0	6 mm J
M001491341 ^b	0.035	0.89	260	0	3 mm J
M001491331 ^b	0.038	0.97	150	0	3 mm J

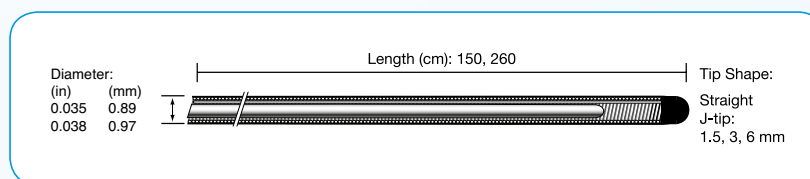

PTFE-coated Starter™ Access

Guidewire – Double Ended^a

UPN – Catalog Number	Diameter (in) (mm)		Length (cm)	Tip Taper (cm)	Tip Shape
M001492201	0.035	0.89	150	4	1.5 mm J
M001492241	0.035	0.89	150	4	3 mm J

PTFE-coated Starter™ Access

Guidewire – Rosen Heavy Duty^a

- For additional support during procedures in highly diseased vessels, renal procedures and interventions in anatomy with short distal purchase

UPN – Catalog Number	Diameter (in) (mm)		Length (cm)	Tip Taper (cm)	Tip Shape
M001491551	0.035	0.89	150	4	1.5 mm J

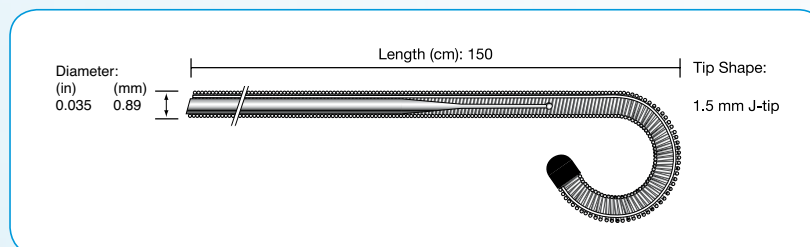

Magic Torque™ Navigating

Glidex™ Coated Hydrophilic Guidewire^d

- Glidex hydrophilic coating on 10cm distal tip
- 3cm shapeable distal tip
- Navigating wire indicated for catheter placement and exchange.

UPN – Catalog Number	Diameter (in) (mm)		Length (cm)	Tip taper* (cm)	Tip Shape
M001465911	0.035	0.89	180	5	Straight
M001465921	0.035	0.89	260	5	Straight

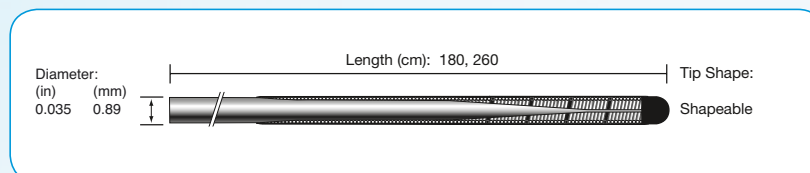

* 4 distal platinum Magic™ markers spaced at 1 cm increment

ZIPWire™ Crossing

Hydrophilic Guidewire

- Secure control when sub-selecting distal and angulated branch vessels
- Excellent visibility for accurate positioning

- Excellent kink-resistance
- Indicated for enhance steerability and control for maneuvering through difficult anatomy

UPN - Catalog Number	Diameter (in) (mm)	Length (cm)	Tip Taper (cm)	Tip Shape
M00146125B1	0.025 0.64	150	3	Angled
M00146126B1	0.025 0.64	150	3	Straight
M00146240B1	0.025 0.64	180	3	Angled
M00146249B1	0.025 0.64	180	3	Straight
M00146254B1	0.025 0.64	260	3	Angled

Standard shaft^c

UPN - Catalog Number	Diameter (in) (mm)	Length (cm)	Tip Taper (cm)	Tip Shape
M00146151B1	0.035 0.89	150	3	Angled
M00146152B1	0.035 0.89	180	3	Angled
M00146154B1	0.035 0.89	260	3	Angled
M00146155B1	0.035 0.89	150	3	Straight
M00146156B1	0.035 0.89	180	3	Straight
M00146159B1	0.035 0.89	260	3	Straight
M00146161B1	0.038 0.97	150	3	Angled
M00146162B1	0.038 0.97	180	3	Angled
M00146165B1	0.038 0.97	150	3	Straight

Stiff shaft^c

UPN - Catalog Number	Diameter (in) (mm)	Length (cm)	Tip Taper (cm)	Tip Shape
M00146300B1	0.035 0.89	80	3	Angled
M00146305B1	0.035 0.89	150	3	Angled
M00146306B1	0.035 0.89	150	3	Straight
M00146308B1	0.035 0.89	180	3	Angled
M00146309B1	0.035 0.89	180	3	Straight
M00146316B1	0.035 0.89	260	3	Angled
M00146317B1	0.035 0.89	260	3	Straight
M00146301B1	0.038 0.97	80	3	Angled
M00146311B1	0.038 0.97	150	3	Angled
M00146312B1	0.038 0.97	150	3	Straight
M00146315B1	0.038 0.97	180	3	Straight

Standard Long Taper^c

UPN - Catalog Number	Diameter (in) (mm)	Length (cm)	Tip Taper (cm)	Tip Shape
M00146325B1	0.035 0.89	150	8	Angled

Stiff Long Taper^c

UPN - Catalog Number	Diameter (in) (mm)	Length (cm)	Tip Taper (cm)	Tip Shape
M00146318B1	0.035 0.89	150	5	Angled
M00146319B1	0.035 0.89	260	5	Angled
M00146321B1	0.038 0.97	150	5	Angled

J-Tip^c

UPN - Catalog Number	Diameter (in) (mm)	Length (cm)	Tip Taper (cm)	Tip Shape
M00146350B1	0.035 0.89	150	3	3mm J

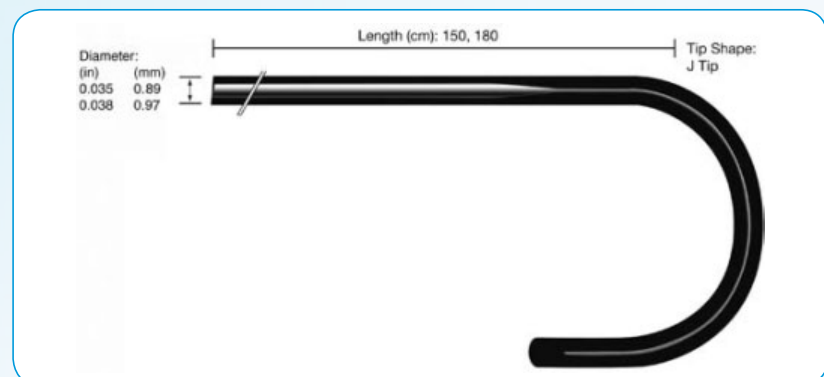
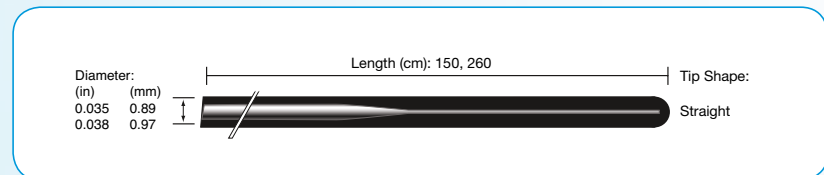
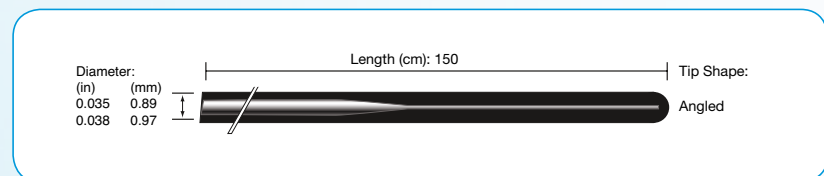
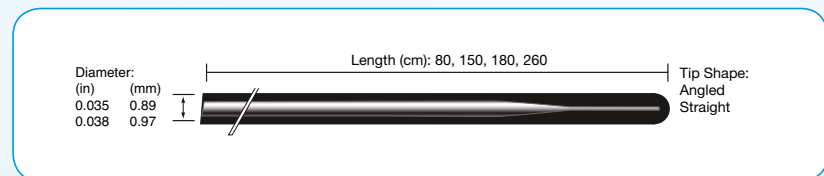
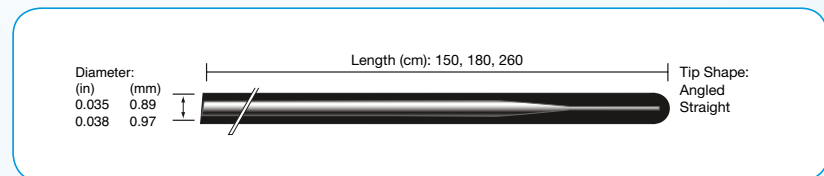
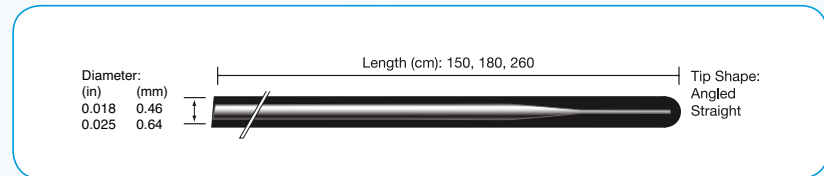

^a Packaged 5/box for lengths up to 150 cm included.

Back-up Meier™ Device Delivery

Steerable Guidewire

- Stiff shaft in stainless steel provides excellent support, while flexible tip reduces the risk of vessel trauma during diagnostic and interventional procedures including AAA endovascular graft procedures
- Highly radiopaque gold-plated tungsten spring coil tip for a good visualization

UPN - Catalog Number	Diameter (in) (mm)		Length (cm)	Tip Taper* (cm)	Tip Shape
H965SCH306001	0.035	0.89	185	16	J
H965SCH306011	0.035	0.89	300	11	C

* 185 cm has 16 cm radiopaque tip
300 cm has 11 cm radiopaque tip

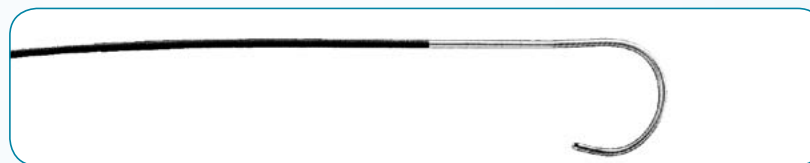

Amplatz Super Stiff™ Device Delivery

Guidewire

- Stainless steel flat coiled wire construction to increase strength for easier access and better stability
- PTFE coating and atraumatic soft floppy tip
- 3 cm shapeable distal tip
- Indicated for catheter placement and exchange. Ideal for contralateral approach.

Straight^c

UPN - Catalog Number	Diameter (in) (mm)		Length (cm)	Tip Taper (cm)	Tip Shape
M001465631	0.035	0.89	75	7	Straight
M001465231	0.035	0.89	145	7	Straight
M001465251	0.035	0.89	180	7	Straight
M001465261	0.035	0.89	260	7	Straight
M001465641	0.038	0.97	75	6	Straight
M001465171	0.038	0.97	145	6	Straight
M001465191	0.038	0.97	180	6	Straight
M001465201	0.038	0.97	260	6	Straight

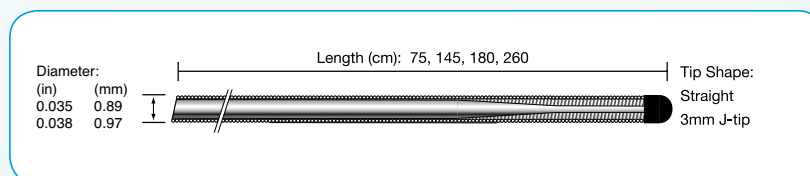

Short Tip^c

UPN - Catalog Number	Diameter (in) (mm)		Length (cm)	Tip Taper (cm)	Tip Shape
M001465091	0.035	0.89	260	1	Straight
M001465241	0.035	0.89	145	4	Straight
M001465101	0.038	0.97	260	1	Straight
M001465181	0.038	0.97	145	4	Straight

3mm J^c

UPN - Catalog Number	Diameter (in) (mm)		Length (cm)	Tip Taper (cm)	Tip Shape
M001465001	0.035	0.89	145	7	3mm J
M001465011	0.035	0.89	180	7	3mm J
M001465021	0.035	0.89	260	7	3mm J
M001465031	0.038	0.97	145	6	3mm J
M001465041	0.038	0.97	180	6	3mm J

Platinum Plus™ Device Delivery

Guidewire with Mediglide™ Silicone Coating

- Extra support wire for device delivery
- Distal platinum coils for good visualization
- Indicated for negotiation of tortuous anatomy and contralateral approaches including smaller vessels and those with short distal purchase

UPN - Catalog Number	Diameter (in) (mm)		Length (cm)	Tip Taper* (cm)	Tip Shape
M001466100	0.025	0.64	180	Short	Straight
M001466050	0.025	0.64	260	Short	Straight

* 9 cm Radiopaque Tip

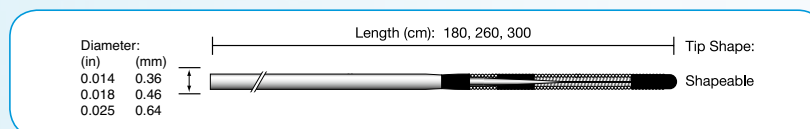

Thruway™ Navigating Peripheral Guidewire^a

- Combining precision and strength
- Secure control when sub-selecting distal and angulated branch vessels
- Indicated for diagnostic and interventional intravascular procedures, above all for renal intervention

UPN – Catalog Number	Diameter (in) (mm)		Length (cm)	Tip Taper*	Tip Shape
M001492751	0.018	0.46	130	Short	Straight
M001492761	0.018	0.46	130	Short	J
M001492771	0.018	0.46	130	Long	Straight
M001492781	0.018	0.46	130	Long	J
M001492791	0.018	0.46	190	Short	Straight
M001492801	0.018	0.46	190	Short	J
M001492811	0.018	0.46	190	Long	Straight
M001492831	0.018	0.46	300	Short	Straight
M001492841	0.018	0.46	300	Short	J
M001492851	0.018	0.46	300	Long	Straight
H74922150010	0.014	0.36	145	Trooper Patriot™ Extension Wire**	

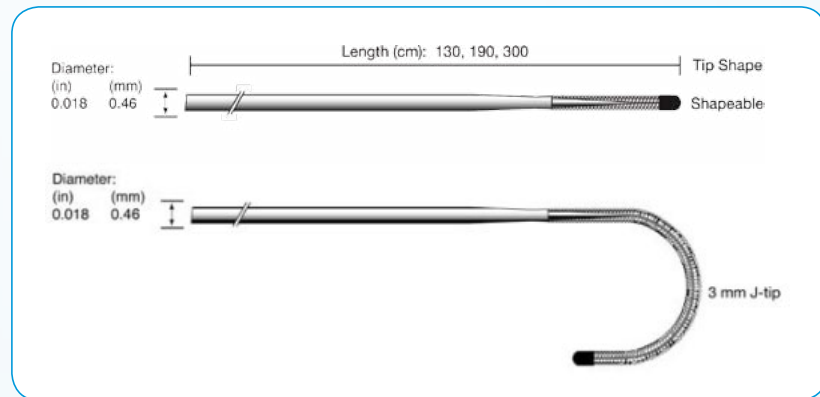

* Short and Long Tapered have a 5 cm platinum radiopaque distal coil followed by three platinum radiopaque marker bands spaced 5 millimeters apart
 ** Compatible with 130cm and 190cm Thruway™ Guidewires
 Note: Thruway™ Guide Wires have brachial and femoral markers located on the proximal segment of the guidewire to aid in estimating a guidewire position

V-18™ ControlWire™ Crossing Guidewire with ICE™ Hydrophilic Coating^a

- Offers the choice of two tip loads (6g & 8g) options with an excellent balance between rail support and distal flexibility
- Indicated for crossing stenosed lesions and occlusions

UPN – Catalog Number	Diameter (in) (mm)		Length (cm)	Tip Taper*	Tip Shape
M001468480	0.018	0.46	110	Short	Straight
M001468500	0.018	0.46	150	Short	Straight
M001468560	0.018	0.46	150	Long	Straight
M001468520	0.018	0.46	200	Short	Straight
M001468580	0.018	0.46	200	Long	Straight
M001468540	0.018	0.46	300	Short	Straight
M001468600	0.018	0.46	300	Long	Straight

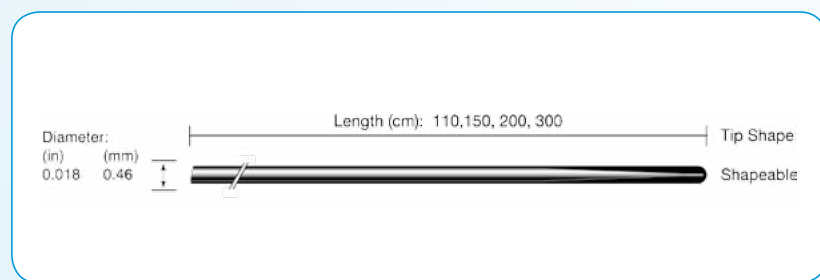

* Short taper has 8cm radiopaque tip
 Long taper has 12cm radiopaque tip

0.035" (0.89 mm) +/-

0.018" (0.46 mm)

0.014" (0.36 mm)

Support Catheters

CTO Devices

^a Packaged 1/box
^b Packaged 5/box



Victory™ Crossing

Guidewires^a

- Designed to break through and cross resistant lesions, offering increasing tip loads from 12 g to 30 g for control and a range of pushability
- Shapeable distal tip
- Hydrophilic distal coating
- Indicated for intraluminal crossing of chronic total occlusions

UPN – Catalog Number	Diameter (in) (mm)		Length (cm)	Tip Length* (cm)	Tip Load (g)
H74939232195120	0.018	0.46	195	2.5	12
H74939232300120	0.018	0.46	300	2.5	12
H74939232195180	0.018	0.46	195	2	18
H74939232300180	0.018	0.46	300	2	18
H74939233195250	0.018	0.46	195	2	25
H74939233300250	0.018	0.46	300	2	25
H74939233195300	0.018	0.46	195	2	30
H74939233300300	0.018	0.46	300	2	30

*2 cm or 2.5 cm radiopaque tip length

ZIPWire™ Crossing

Hydrophilic Guidewire^b

- Secure control when sub-selecting distal and angulated branch vessels
- Excellent visibility for accurate positioning
- Excellent kink-resistance
- Indicated for enhance steerability and control for maneuvering through difficult anatomy

UPN – Catalog Number	Diameter (in) (mm)		Length (cm)	Tip Taper (cm)	Tip Shape
M00146231B1	0.018	0.46	150	3	Angled
M00146232B1	0.018	0.46	180	3	Angled
M00146235B1	0.018	0.46	150	3	Straight
M00146236B1	0.018	0.46	180	3	Straight

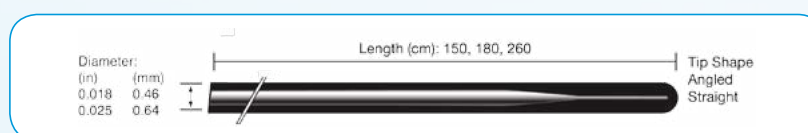

Platinum Plus™ Device Delivery

Guidewire

- Extra support wire for device delivery
- Distal platinum coils for good visualization
- Indicated for negotiation of tortuous anatomy and contralateral approaches including smaller vessels and those with short distal purchase

Guidewires with Mediglide™ Silicone Coating – Long tip

UPN – Catalog Number	Diameter (in) (mm)		Length (cm)	Tip Taper* (cm)	Tip Shape
M001466000	0.018	0.46	145	Long	Straight
M001466010	0.018	0.46	180	Long	Straight
M001466020	0.018	0.46	260	Long	Straight

*15 cm radiopaque tip

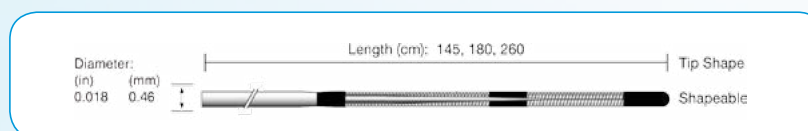

Guidewires with Mediglide™ Silicone Coating – Short tip

UPN – Catalog Number	Diameter (in) (mm)		Length (cm)	Tip Taper* (cm)	Tip Shape
M001466040	0.018	0.46	180	Short	Straight
M001466050	0.018	0.46	260	Short	Straight

*7 cm radiopaque tip

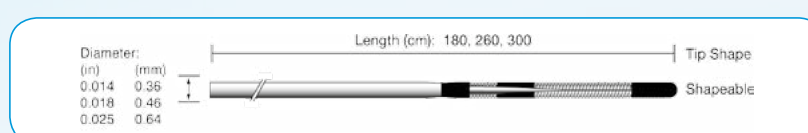

0.035" (0.89 mm) +/-

0.018" (0.46 mm)

0.014" (0.36 mm)

Support Catheters

CTO Devices

Journey™ Navigating Peripheral Guidewire^a

- Designed to exceed conventional guidewire performance by providing far superior torque control and so a great navigability without compromising flexibility.
- Indicated for navigating highly tortuous, distal and difficult-to-access anatomy

UPN – Catalog Number	Diameter (in) (mm)	Length (cm)	Tip Taper* (cm)	Tip Shape
M001391260	0.014 0.36	185	7	Straight
M001391270	0.014 0.36	185	7	Angled
M001391280	0.014 0.36	300	7	Straight
M001391290	0.014 0.36	300	7	Angled

*2cm radiopaque tip

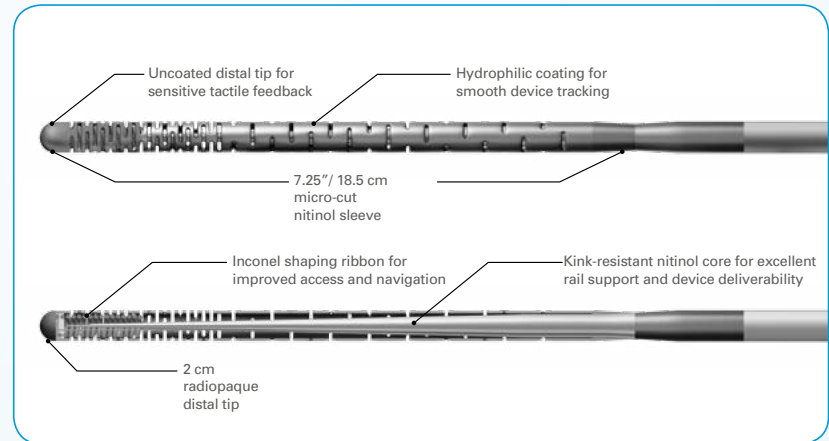

Thruway™ Navigating Peripheral Guidewire^a

- Combining precision and strength
- Secure control when sub-selecting distal and angulated branch vessels
- Indicated for diagnostic and interventional intravascular procedures, above all for renal intervention

UPN – Catalog Number	Diameter (in) (mm)	Length (cm)	Tip Taper*	Tip Shape
M001492871	0.014 0.36	130	Short	Straight
M001492881	0.014 0.36	130	Short	J
M001492891	0.014 0.36	130	Long	Straight
M001492911	0.014 0.36	130	Extra Long	Straight
M001492921	0.014 0.36	190	Short	Straight
M001492931	0.014 0.36	190	Short	J
M001492941	0.014 0.36	190	Long	Straight
M001492971	0.014 0.36	300	Short	Straight
M001492981	0.014 0.36	300	Long	Straight

* Short and Long Tapered have a 3cm platinum radiopaque distal coil followed by three platinum radiopaque marker bands spaced 5mm apart. Extra Long Tapered Guides have a platinum 5cm radiopaque distal coil followed by four platinum radiopaque marker bands spaced 5mm apart

Note: Thruway™ Guide Wires have brachial and femoral markers located on the proximal segment of the guidewire to aid in estimating a guidewire position relative to the distal guide catheter tip

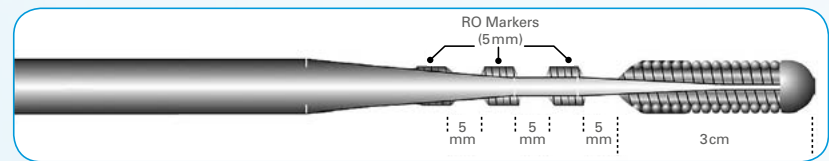

0.035" (0.89 mm) +/-

0.018" (0.46 mm)

0.014" (0.36 mm)

Support Catheters

CTO Devices



V-14™ ControlWire™ Crossing

Guidewire with ICE™ Hydrophilic Coating^a

- Offers the choice of two tip loads options with an excellent balance between rail support and distal flexibility
- Indicated for crossing stenosed lesions and occlusions

UPN - Catalog Number	Diameter (in) (mm)		Length (cm)	Tip Taper*	Tip Shape
H74939216718210	0.014	0.36	182	Short	Straight
H74939216718220	0.014	0.36	182	Short	Angled
H74939216730010	0.014	0.36	300	Short	Straight
H74939216730020	0.014	0.36	300	Short	Angled
H74939216918210	0.014	0.36	182	Long	Straight
H74939216918220	0.014	0.36	182	Long	Angled
H74939216930010	0.014	0.36	300	Long	Straight
H74939216930020	0.014	0.36	300	Long	Angled

*2 cm radiopaque tip

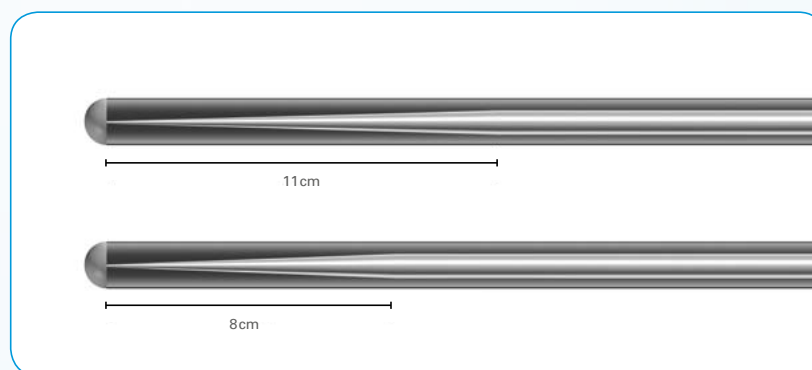

Victory™ Crossing

Guidewires^a

- Designed to break through and cross resistant lesions, offering increasing tip loads from 12 g to 30 g for control and a range of pushability
- Shapeable distal tip
- Hydrophilic distal coating
- Indicated for intraluminal crossing of chronic total occlusions

UPN - Catalog Number	Diameter (in) (mm)		Length (cm)	Tip Length* (cm)	Tip Load (g)
H74939230195120	0.014	0.36	195	2.5	12
H74939230300120	0.014	0.36	300	2.5	12
H74939230195180	0.014	0.36	195	2.5	18
H74939230300180	0.014	0.36	300	2.5	18
H74939231195250	0.014	0.36	195	2	25
H74939231300250	0.014	0.36	300	2	25
H74939231195300	0.014	0.36	195	2	30
H74939231300300	0.014	0.36	300	2	30

*2 cm or 2.5 cm radiopaque tip length

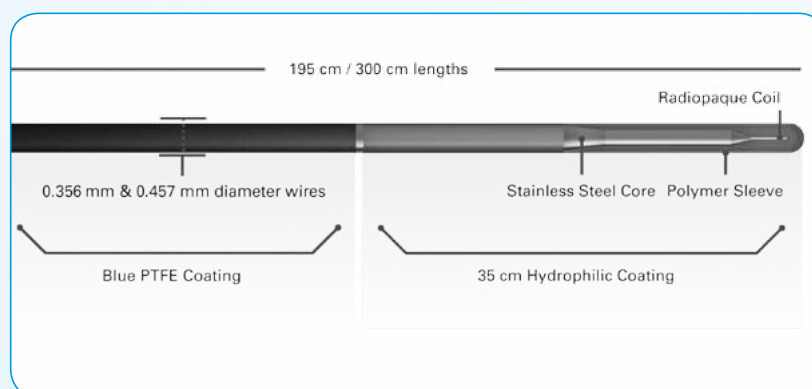

Platinum Plus™ Device Delivery

Guidewire with Glidex™ Hydrophilic Coating^a

- Extra support wire for device delivery
- Distal platinum coils for good visualization
- 8 cm Glidex distal hydrophilic coating
- Indicated for negotiation of tortuous anatomy and contralateral approaches including smaller vessels and those with short distal purchase

UPN - Catalog Number	Diameter (in) (mm)		Length (cm)	Tip Taper* (cm)	Tip Shape
M001467400	0.014	0.36	180	9	Straight
M001467120	0.014	0.36	300	7	Straight

*5 cm Radiopaque tip length for 180 cm
3 cm Radiopaque tip length for 300 cm

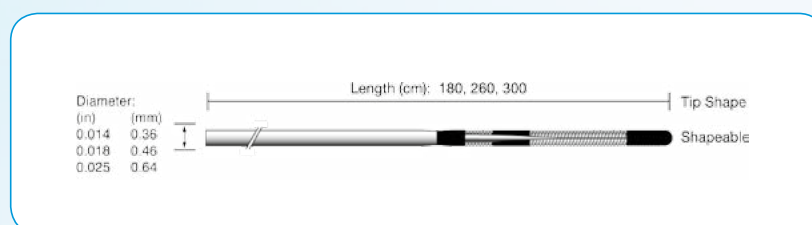

0.035" (0.89 mm) +/-

0.018" (0.46 mm)

0.014" (0.36 mm)

Support Catheters

CTO Devices

Rubicon™

Support Catheters

- Enhances lesion access and entry
- Facilitates crossing of tight occlusions & challenging vasculature
- Enables delivery with and exchange of 0.014" (0.36 mm), 0.018" (0.46 mm) & 0.035" (0.89 mm) guidewires

Rubicon 14

Order Number	Guidewire Compatibility (in/mm)	Sheath Compatibility	Length (cm)	Tip Shape	Tip Entry Profile	Proximal Shaft Profile	Marker Band Spacing
H74939212014131	0.014" (0.36 mm)	4F*	135	Straight	1.4F*	3.4F*	15mm
H74939212014151	0.014" (0.36 mm)	4F*	150	Straight	1.4F*	3.4F*	15mm

Rubicon 18

Order Number	Guidewire Compatibility (in/mm)	Sheath Compatibility	Length (cm)	Tip Shape	Tip Entry Profile	Proximal Shaft Profile	Marker Band Spacing
H74939239018091	0.018" (0.46 mm)	4F*	90	Straight	1.7F*	4F*	15mm
H74939212014151	0.018" (0.46 mm)	4F*	135	Straight	1.7F*	4F*	15mm
H74939239018151	0.018" (0.46 mm)	4F*	150	Straight	1.7F*	4F*	15mm

Rubicon 35

Order Number	Guidewire Compatibility (in/mm)	Sheath Compatibility	Length (cm)	Tip Shape	Tip Entry Profile	Proximal Shaft Profile	Marker Band Spacing
H74939240035061	0.035" (0.89 mm)	5F*	65	Straight	2.84F*	5.1F*	50mm
H74939240035091	0.035" (0.89 mm)	5F*	90	Straight	2.84F*	5.1F*	50mm
H74939240035131	0.035" (0.89 mm)	5F*	135	Straight	2.84F*	5.1F*	50mm
H74939240035151	0.035" (0.89 mm)	5F*	150	Straight	2.84F*	5.1F*	50mm

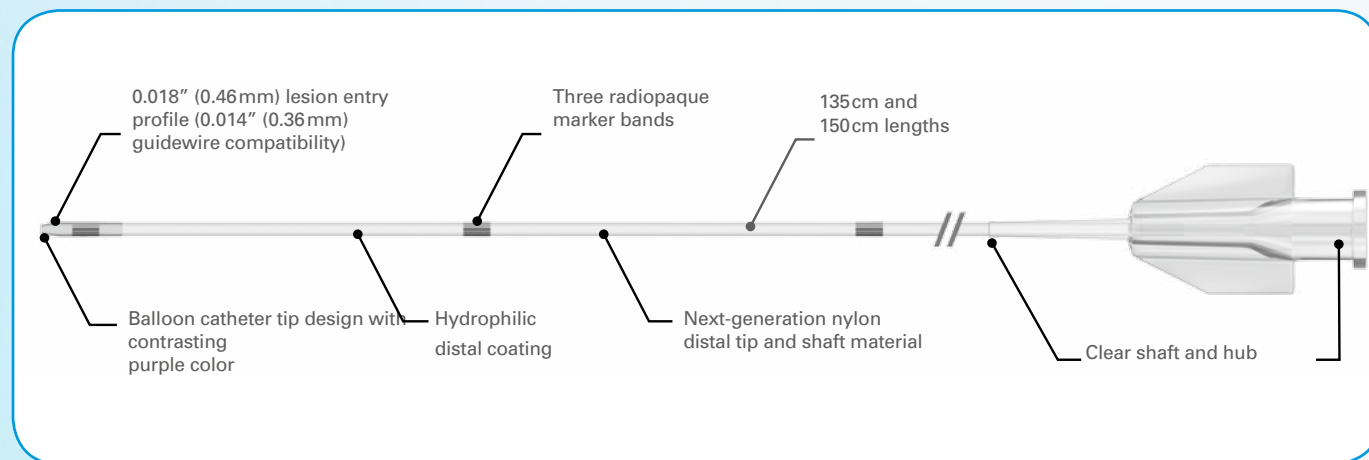

Rubicon 14 support catheter

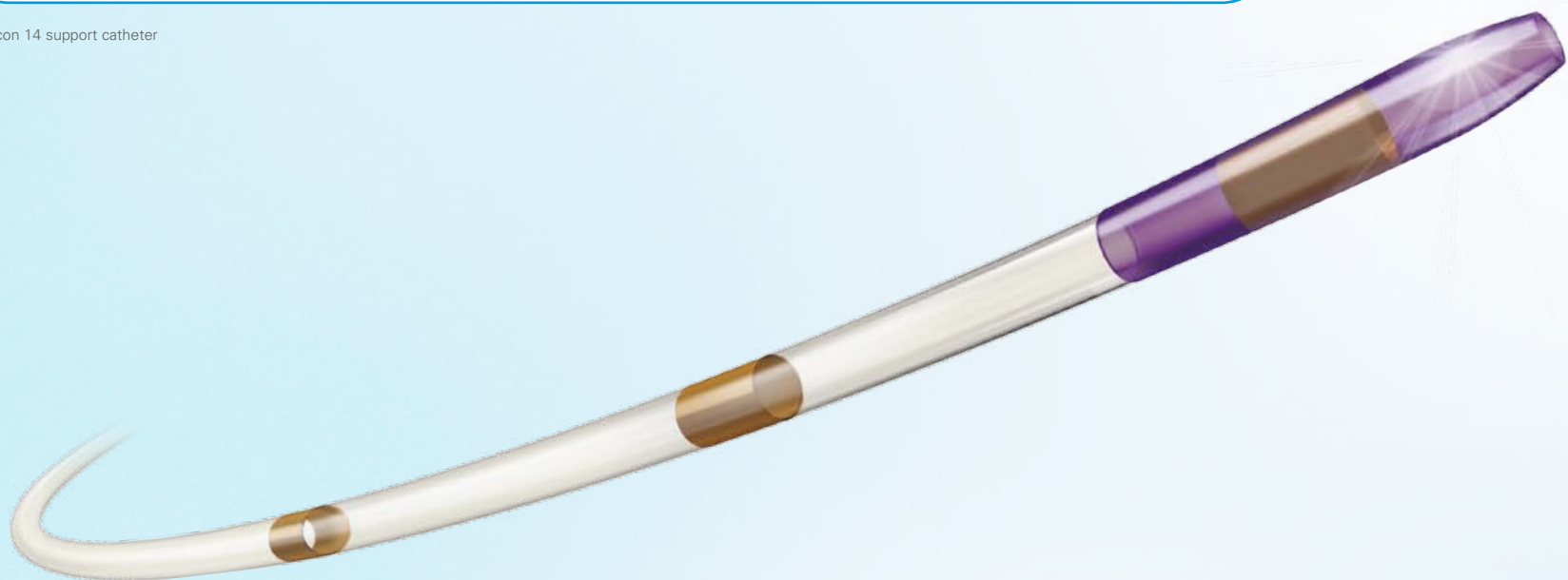

* 1,4F = 0,47 mm (0,019")
 1,7F = 0,57 mm (0,022")
 2,84F = 0,95 mm (0,037")
 3,4F = 1,13 mm (0,044")
 4F = 1,33 mm (0,052")
 5F = 1,67 mm (0,066")
 5,1F = 1,7 mm (0,067")

0.035" (0.89 mm) +/-

0.018" (0.46 mm)

0.014" (0.36 mm)

Support Catheters

CTO Devices



TruePath™

CTO Device

A powerful new solution for intraluminal treatment of chronic total occlusions. At 0.018"/0.46 mm in diameter, the guidewire-like profile is nearly half the size of competitive offerings, designed for optimal steering and crossing. Once positioned, the self-rotating tip works effortlessly

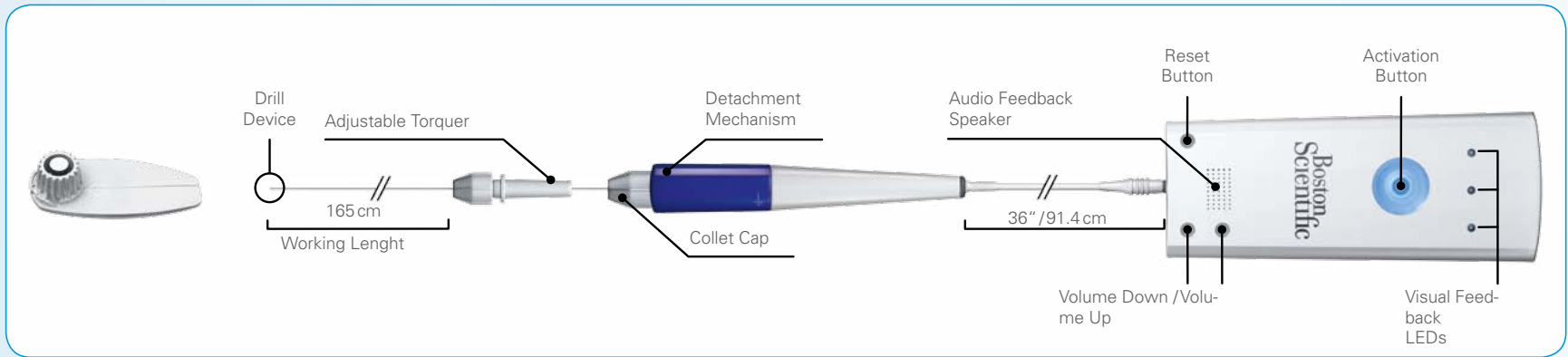

TruePath™ CTO Device

Order Number	Description
H74939208181650	TruePath CTO Device
H74939208001601	TruePath Extension Wires (5/box)

TruePath™ Compatibility

Size OD		Length		Sheath Compatibility		Min. Guide Catheter ID		Tip Profile	
(in)	(mm)	(cm)	(in)	(mm)	(in)	(mm)	(in)	(mm)	
0.018	0.46	165	0.018	0.46	0.014	0.36	0.017	0.43	

compatible catheters*

* With usable lengths of ≤ 135 cm

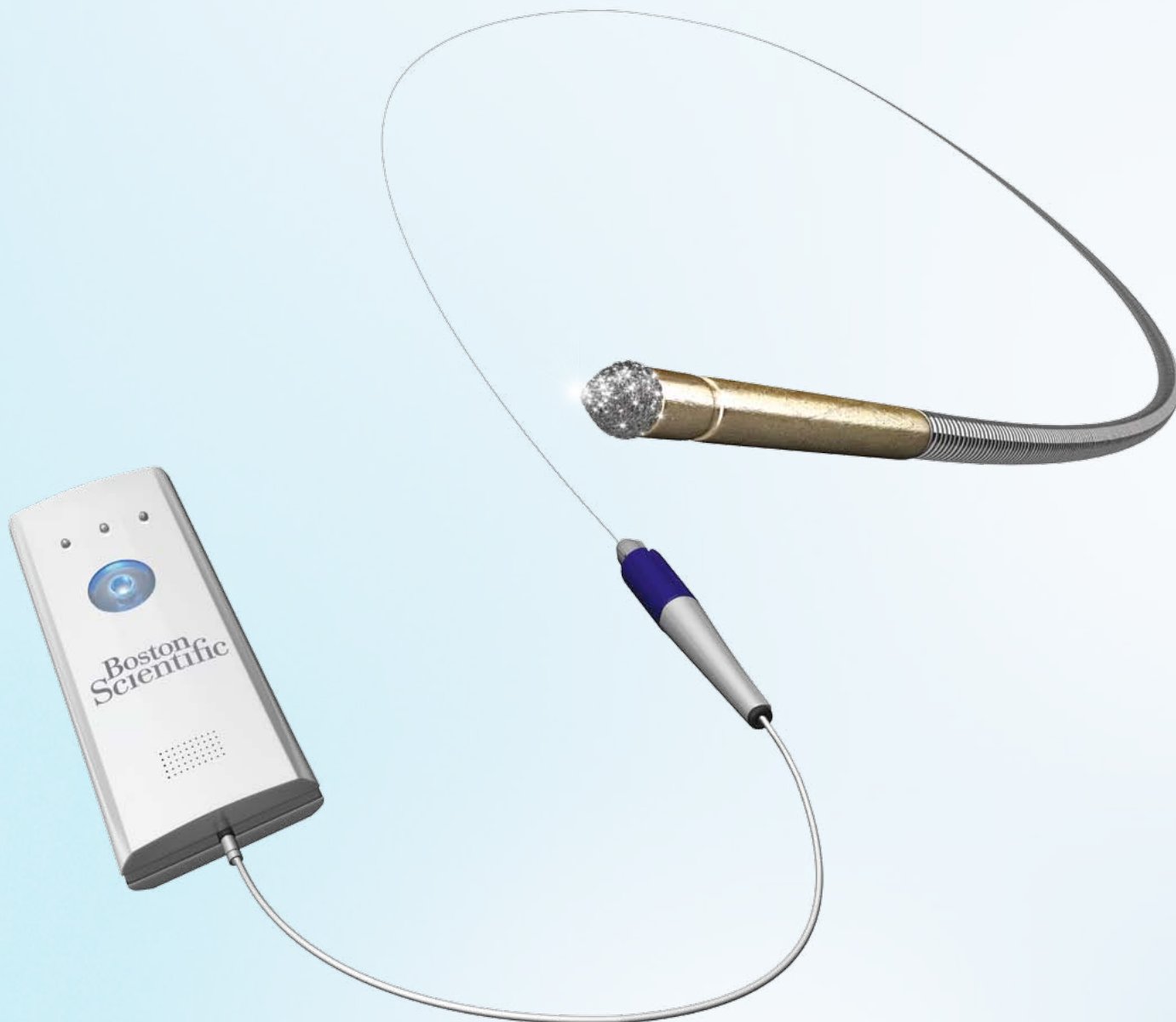

0.035" (0.89 mm) +/-

0.018" (0.46 mm)

0.014" (0.36 mm)

Support Catheters

CTO Devices



OffRoad™ Re-entry Catheter System

The industry's most elegant dual-component solution for challenging lesions. Re-entry is intuitive as the 5.4 mm articulating Positioning Balloon directs the system, creating a path for the Micro-Catheter Lancet to re-enter the vessel with precision

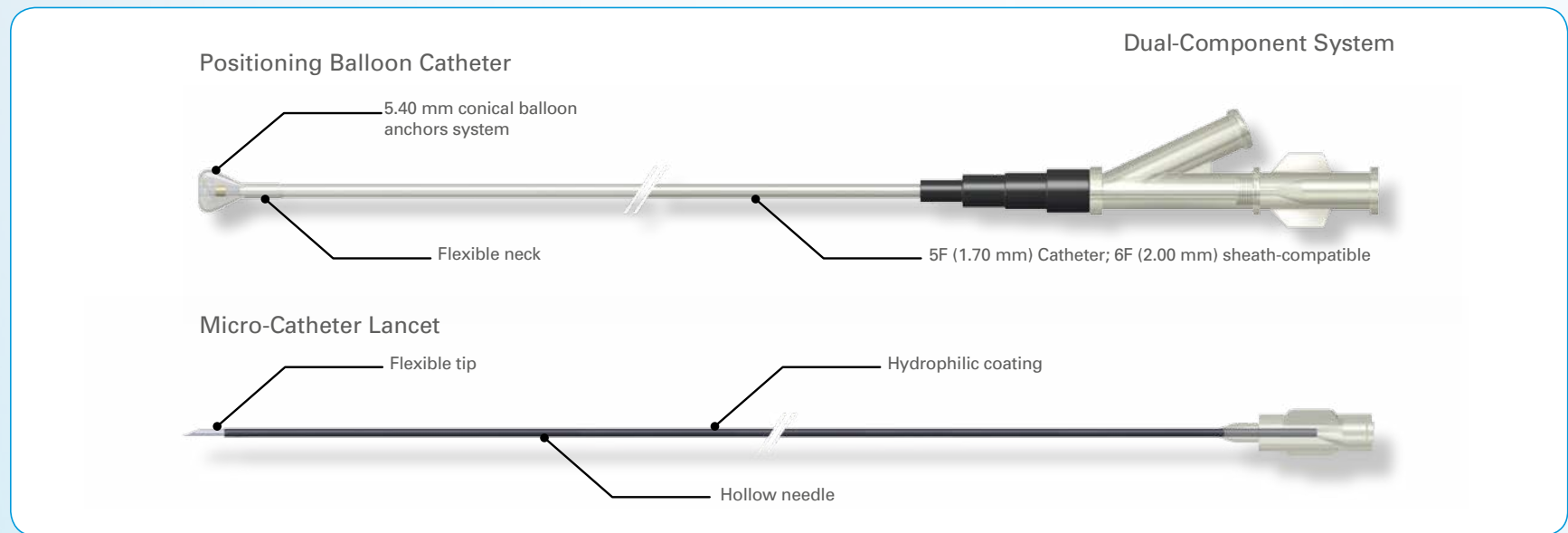

Compatibility Chart for OffRoad™ Re-entry Catheter – Short (70 cm)

Order Number		Length (cm)	Catheter Shaft OD		Nominal Balloon Diameter (mm)	Nominal Inflation Pressure		Maximum Inflation Pressure		Sheath Diameter		Recommended Guidewire OD	
			(F)	(mm)		(ATM)	(kPa)	(ATM)	(kPa)	(F)	(mm)	(in)	(mm)
H74939202070540	Positioning Balloon Catheter	70	5	1.75	5.4	2	203	3.25	329	6	2	0.035	0.89
	Micro-Catheter Lancet	100	2.4	0.85	N/A	N/A	N/A	N/A	N/A	N/A	N/A	0.014*	0.36*

Compatibility Chart for OffRoad™ Re-entry Catheter – Long (100 cm)

Order Number		Length (cm)	Catheter Shaft OD		Nominal Balloon Diameter (mm)	Nominal Inflation Pressure		Maximum Inflation Pressure		Sheath Diameter		Recommended Guidewire OD	
			(F)	(mm)		(ATM)	(kPa)	(ATM)	(kPa)	(F)	(mm)	(in)	(mm)
H74939202100540	Positioning Balloon Catheter	100	5	1.75	5.4	2	203	3.25	329	6	2	0.035	0.89
	Micro-Catheter Lancet	109	2.4	0.85	N/A	N/A	N/A	N/A	N/A	N/A	N/A	0.014*	0.36*

* Non-Coated. Do not use a 0.014 in (0.36 mm) guidewire that has a polymer (plastic) cover/sleeve with the Micro-Catheter Lancet. If using a 0.014 in (0.36 mm) PTFE coated guidewire, do not manipulate the PTFE coated part of the wire (i.e. back-and-forth movements) beyond the tip of the Micro-Catheter Lancet. Using an inappropriate guidewire may result in damage to the guidewire such as abrasion of the coating, release of polymer fragments or separation of the guidewire.

Recommended Guidewire: Platinum Plus™ Guidewire

Order Number	Length		Diameter	
	(cm)	(in)	(in)	(mm)
M001467400	180	0.014	0.014	0.36
M001467120	300	0.014	0.014	0.36

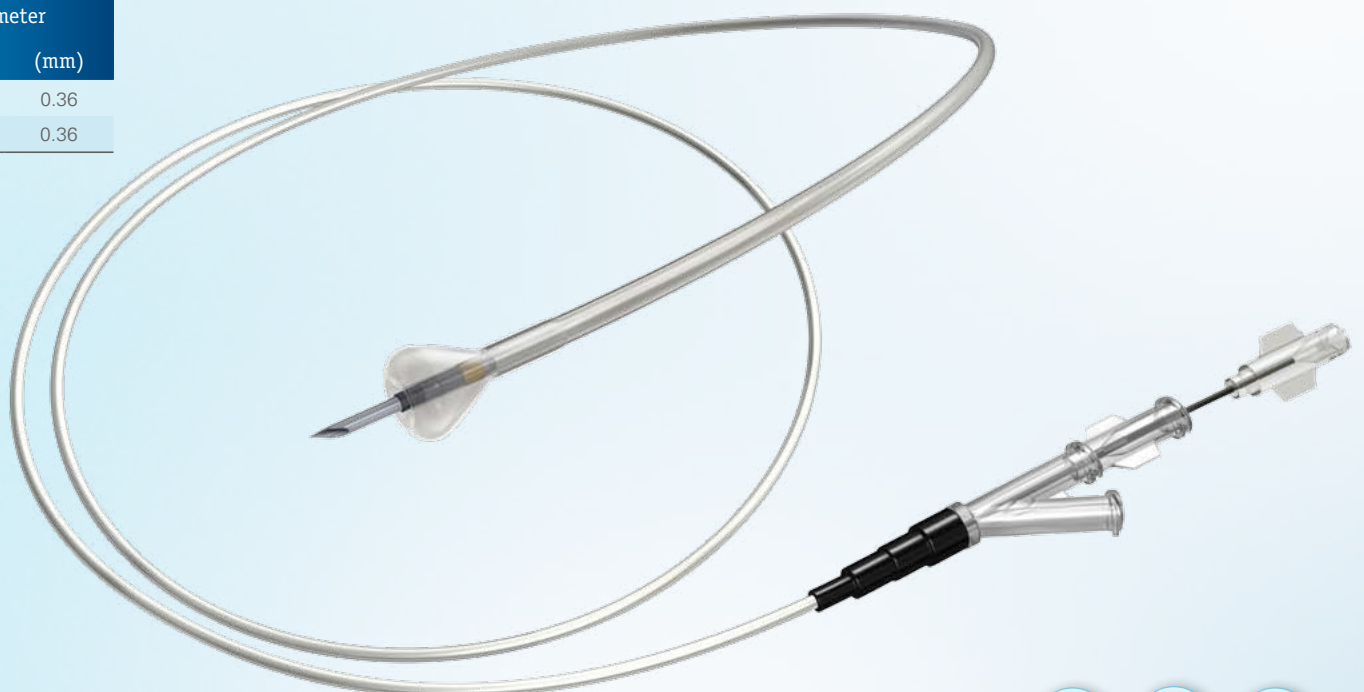

0.035" (0.89 mm) +/-

0.018" (0.46 mm)

0.014" (0.36 mm)

Support Catheters

CTO Devices

Illustrations for information purposes – not indicative of actual size or clinical outcome.

All cited trademarks are the property of their respective owners. CAUTION: The law restricts these devices to sale by or on the order of a physician. Indications, contraindications, warnings and instructions for use can be found in the product labelling supplied with each device. Information for the use only in countries with applicable health authority product registrations.

Information contained herein is for distribution outside the U.S. only.

PI-188601-AA Sept 2013 Printed in Germany by medicalvision.

**Boston
Scientific**

Advancing science for life™

www.bostonscientific-international.com

© 2013 Boston Scientific Corporation
or its affiliates. All rights reserved.
DINPER4634EA

