

Varithena[®]

(polidocanol injectable foam)

VARITHENA Delivery System

Instructions for Use

Please read all prescribing information before using the product.

Rx Only

The Instructions for Use are for the entire VARITHENA system. There are 4 packaging configurations:

180 mg/18 mL Configuration:

- Option A: Bi-Canister box and Administration Pack*
- Option B: Convenience box (Bi-Canister Box + 3 Ancillary Packs + 3 VARITHENA transfer units)*

*The components in each packaging configuration are to be used only in conjunction with each other for activation of VARITHENA. Administration Packs can be used for either configuration for further treatment sessions.

180 mg/18 mL Configuration: Always write the activation date and time on the canister and verify the product has not expired prior to use. Once the VARITHENA canister has been activated, the shelf life for the product is thirty (30) days.

A canister of VARITHENA generates 90 mL of foam which, following purging instructions contained in this IFU, is sufficient to yield 45 mL of usable foam for injection. The gas mix of the foam is 65:35 O₂:CO₂.

77.5 mg/7.75 mL Configuration:

- Option A: Bi-Canister box and Administration Pack*
- Option B: Convenience box (Bi-Canister Box + 1 Ancillary Pack + 1 VARITHENA transfer unit)*

*The components in each packaging configuration are to be used only in conjunction with each other for activation of VARITHENA.

77.5 mg/7.75 mL Configuration: Always write the activation date and time on the canister and verify the product has not expired prior to use. Once the VARITHENA canister has been activated, the shelf life for the product is thirty (30) days.

A canister of VARITHENA generates 30 mL of foam which, following purging instructions contained in this IFU, is sufficient to yield 15 mL of usable foam for injection. The gas mix of the foam is 65:35 O₂:CO₂.

WARNINGS:

As the foam fills the syringe and before injecting, inspect the syringe full of foam for any visible bubbles. If there are any present, the foam should be emptied into the VARITHENA transfer unit waste chamber and the syringe refilled.

Do not shake VARITHENA canisters.

Always use a fresh pair of sterile gloves when handling the Bi-Canister and VARITHENA transfer unit.

Notes: Use a new sterile syringe after each injection. Never fill a syringe until just before the foam is required.

Use foam within 75 seconds of generation or discard and generate new foam.

The activated VARITHENA canister should always be stored with a VARITHENA transfer unit in place in the upright position at or below 86°F (30°C) in an appropriately controlled clean area to limit contamination. A new VARITHENA transfer unit must be used for each treatment session.

Unpacking VARITHENA:

Option A for 180 mg/18 mL: Bi-Canister Box and Administration Pack

Option A for 77.5 mg/7.75 mL: Bi-Canister Box and Administration Pack

Gather all the items needed for the generation of foam: the VARITHENA Bi-Canister box (Figure 1a), Administration Pack (including: VARITHENA transfer unit, manometer tube, compression pad and silicone-free syringes) (Figure 1b), and the following items that are not supplied: scissors, pen, sterile alcoholic wipes, timer and gloves (Figure 1c).

Open the VARITHENA Bi-Canister box and remove the VARITHENA Bi-Canister pouch. Open the Administration Pack and remove the components. Inspect the pouch and components for damage (do not use product if there are any visible signs of damage to pouch or components).

Figure 1a – VARITHENA Bi-Canister

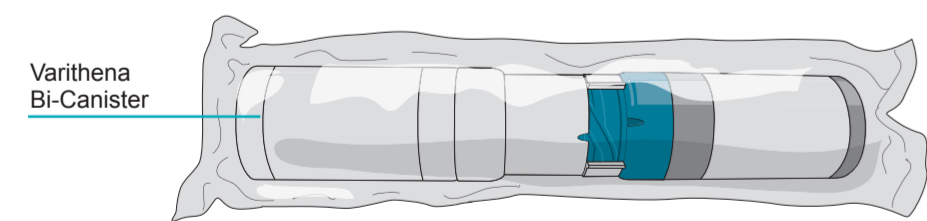

Figure 1b – Administration Pack

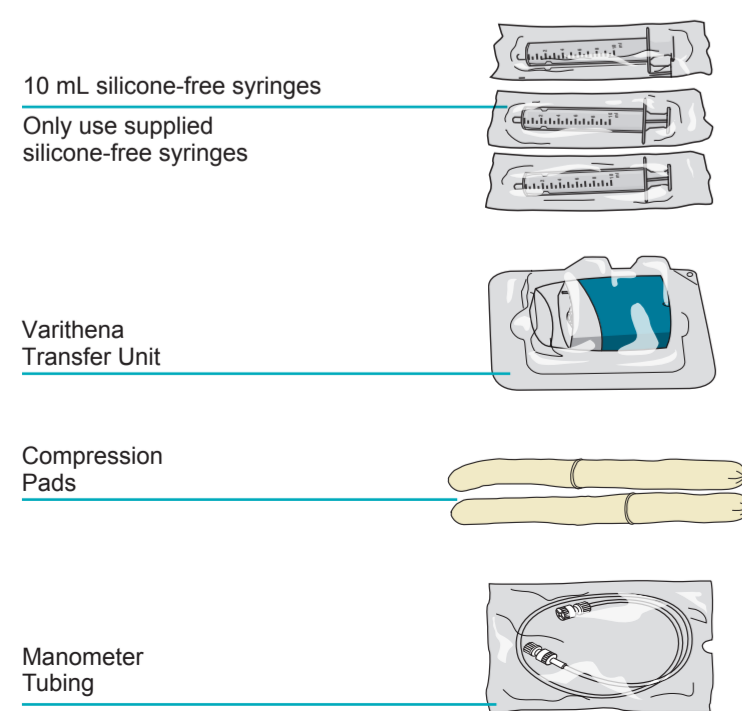
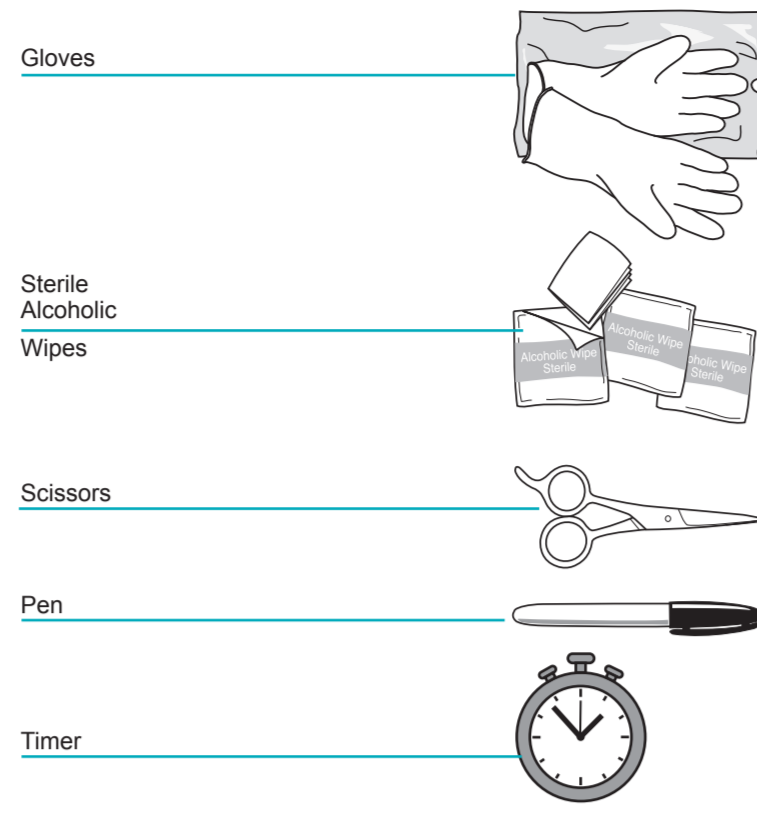

Figure 1c – Additional Procedure Items (not supplied)



Unpacking VARITHENA:

Option B for 180 mg/18 mL Product: Convenience Box (Bi-Canister Box + 3 Ancillary Packs + 3 VARITHENA transfer units)

Gather all the items needed for the generation of foam: the VARITHENA Bi-Canister Box (Figure 2a), Ancillary Pack (including silicone-free syringes, manometer tubing, and compression pads (Figure 2b) and VARITHENA transfer unit (Figure 2c), and the following items that are not supplied: scissors, pen, sterile alcoholic wipes, timer and gloves (Figure 2d).

Open the VARITHENA Convenience box and remove all the components. Open the VARITHENA Bi-Canister box and remove the VARITHENA Bi-Canister pouch. Open an Ancillary Pack and remove the components. Inspect the pouch and components for damage (do not use product if there are any visible signs of damage to pouch or components).

Figure 2a – VARITHENA Bi-Canister

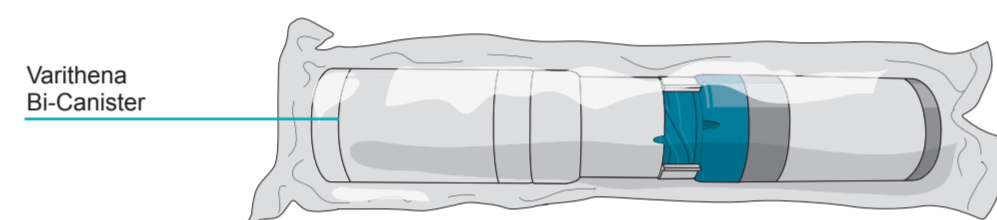

Figure 2b – Three Ancillary Packs

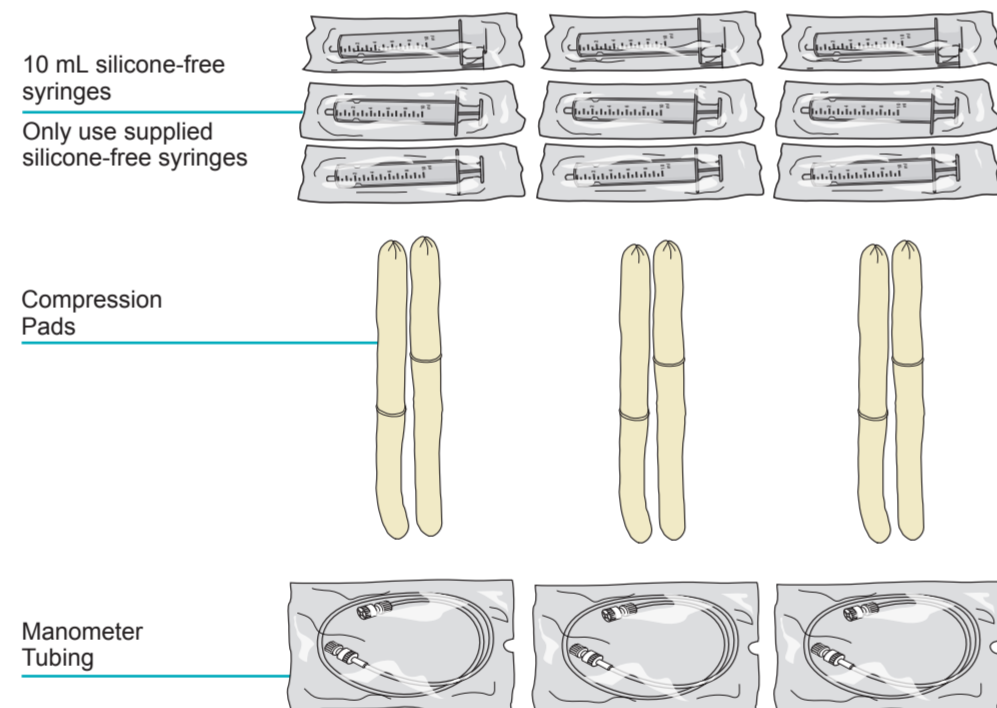
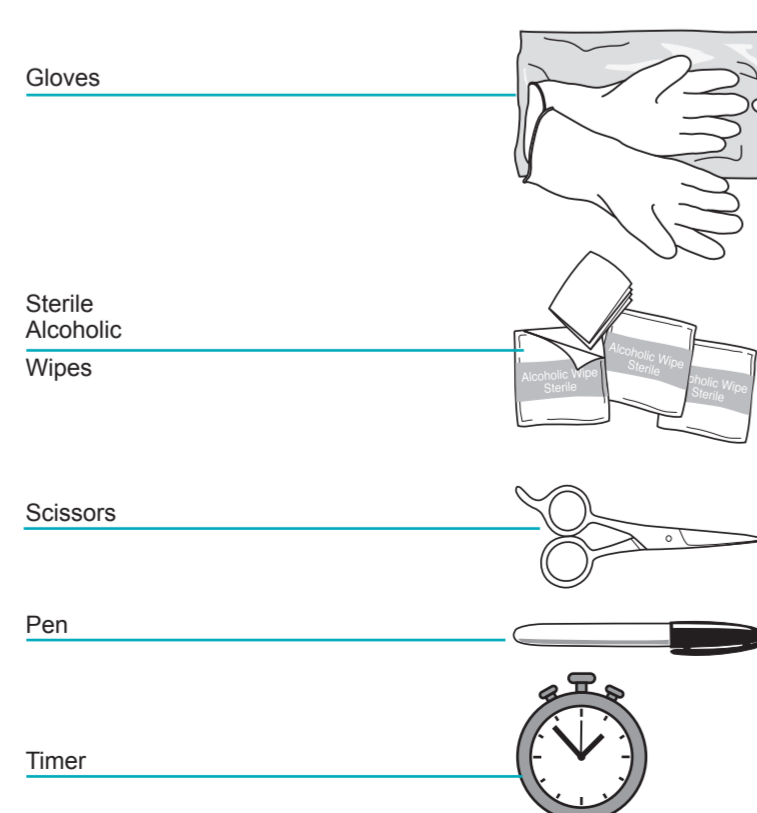

Figure 2c – Three VARITHENA transfer units



Figure 2d – Additional Procedure Items (not supplied)



Unpacking VARITHENA:

Option B for 77.5 mg/7.75 mL product: Convenience Box (Bi-Canister Box + 1 Ancillary Pack + 1 VARITHENA transfer unit)

Gather all the items needed for the generation of foam: the VARITHENA Bi-Canister Box (Figure 3a), Ancillary Pack (including silicone-free syringes, manometer tubing, and compression pads (Figure 3b) and VARITHENA transfer unit (Figure 3c), and the following items that are not supplied: scissors, pen, sterile alcoholic wipes, timer and gloves (Figure 3d).

Open the VARITHENA Convenience box and remove all the components. Open the VARITHENA Bi-Canister box and remove the VARITHENA Bi-Canister pouch. Open the Ancillary Pack and remove the components. Inspect the pouch and components for damage (do not use product if there are any visible signs of damage to pouch or components).

Figure 3a – VARITHENA Bi-Canister

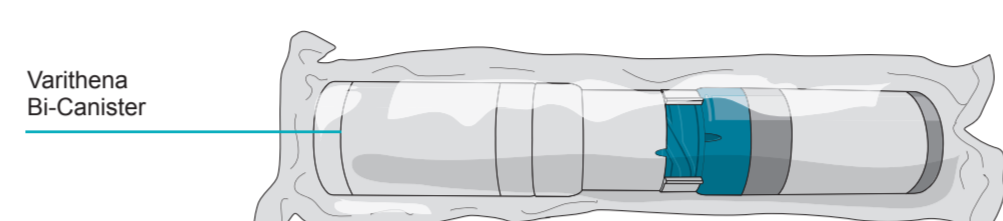

Figure 3b – Ancillary Pack

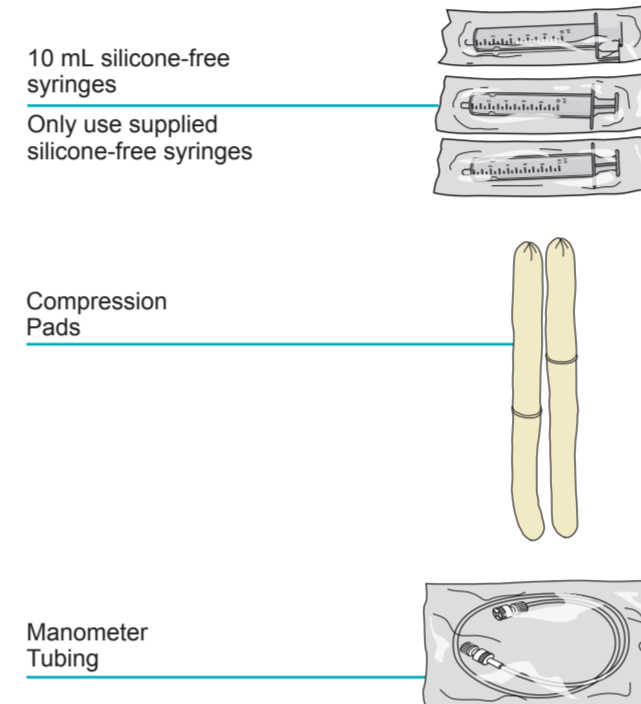
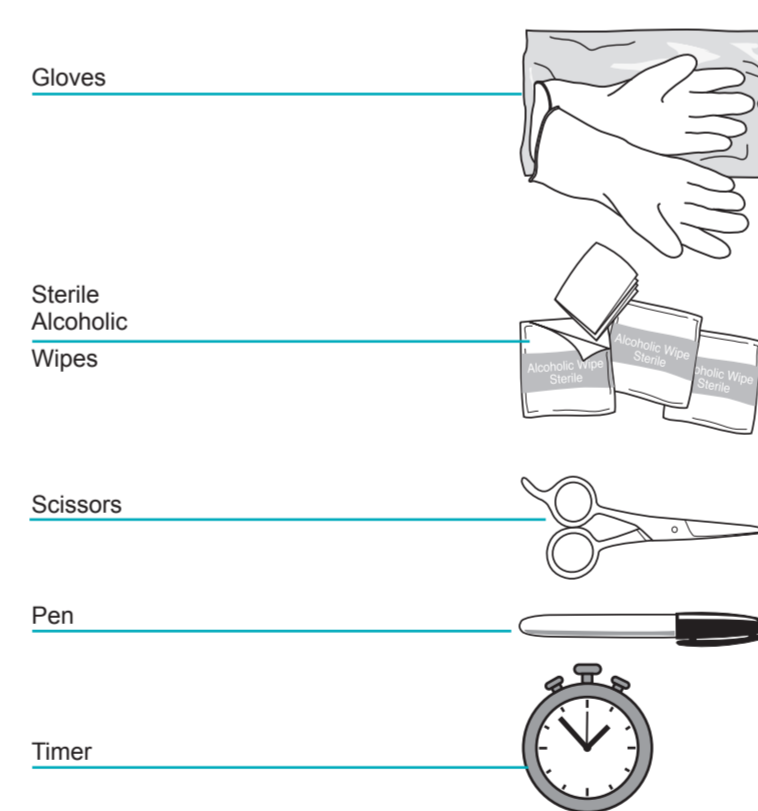

Figure 3c – VARITHENA transfer unit



Figure 3d – Additional Procedure Items (not supplied)



Preparing the Patient

Preparations for treating the patient with VARITHENA should include the following steps:

- Position the patient comfortably on the treatment table in a supine position with their hip externally rotated to facilitate access to the GSV.
- Use ultrasound to find the best site for venous access.
- Using an aseptic technique, infiltrate the skin over the venous access point with local anesthetic.
- Obtain venous access under ultrasound guidance.
- IV catheters that are 16 to 22 gauge and 40 - to 50 - mm long or micropuncture sets are recommended for venous access.
- Prefill the manometer tube with sterile heparinized normal saline solution and connect to the IV catheter.
- Confirm venous access by aspirating with a syringe, blood should be dark and under low pressure.
- Flush the IV catheter and manometer tube with heparinized normal saline and secure it to the skin with adhesive tape, leave the saline syringe connected.
- With the IV catheter in place and secure, place the patient supine and elevate the leg to approximately 45 degrees.

Complete all preparation of the patient and preparations for VARITHENA injectable foam injection before generation of the foam.

VARITHENA Preparation

- Wearing appropriate sterile gloves, open Bi-Canister pouch using a pair of scissors. Place canisters upright on a cleaned (sterile wipes) stable surface with the white oxygen canister on top (Figure 4). Discard empty pouch.
- Remove the safety clip by lifting one corner of the clip out (Figure 5). Discard the safety clip.

Figure 4

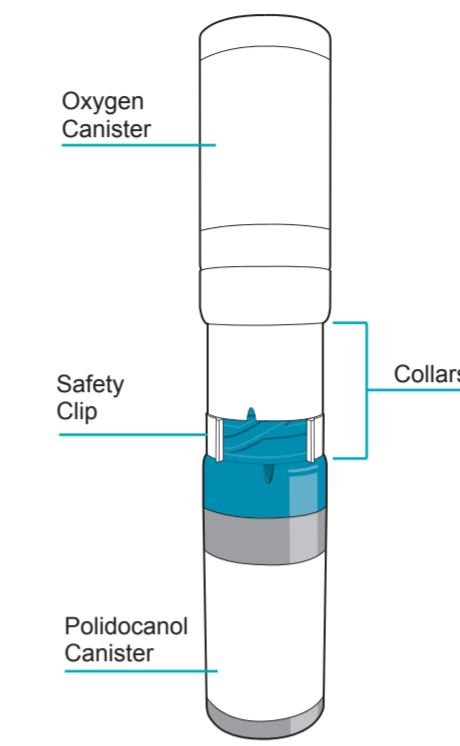
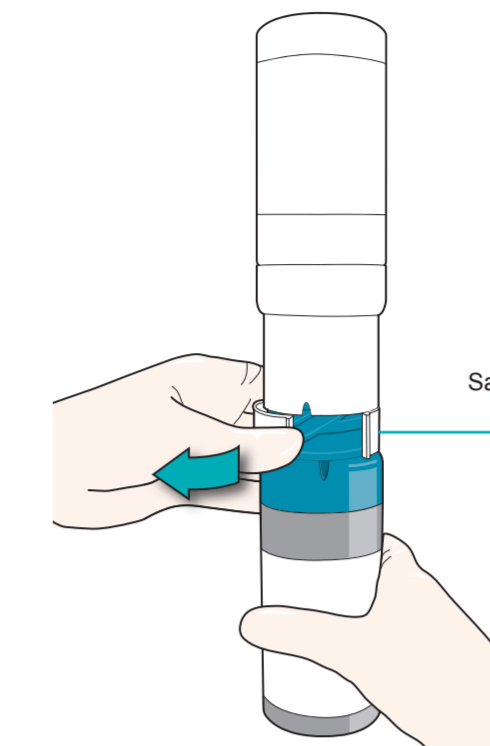

Figure 5



Gas Activation of the VARITHENA Canister

- To begin the gas transfer, twist the canisters together clockwise (Figure 6) until they come to a stop and the small indicators/marks on the collars are aligned (Figure 7). You may hear a bubbling sound.

While the canisters are activating, keep them upright on the clean flat surface for 1 minute. Use a timing device to keep track of the 1 minute time. Extended gassing periods (more than 10 minutes) are undesirable.

Figure 6

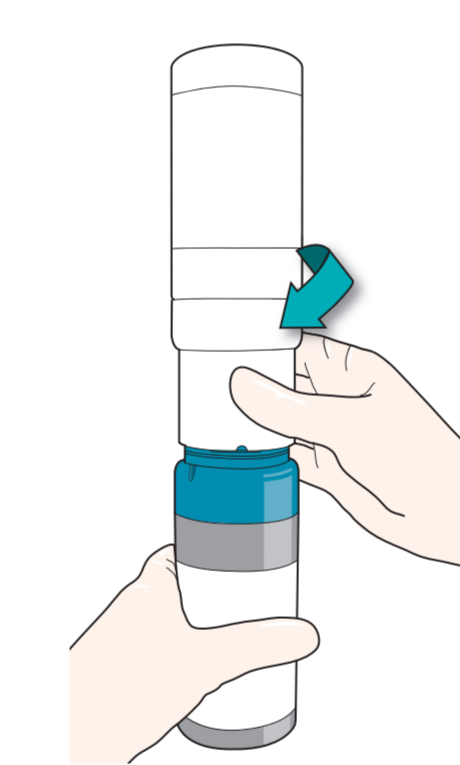
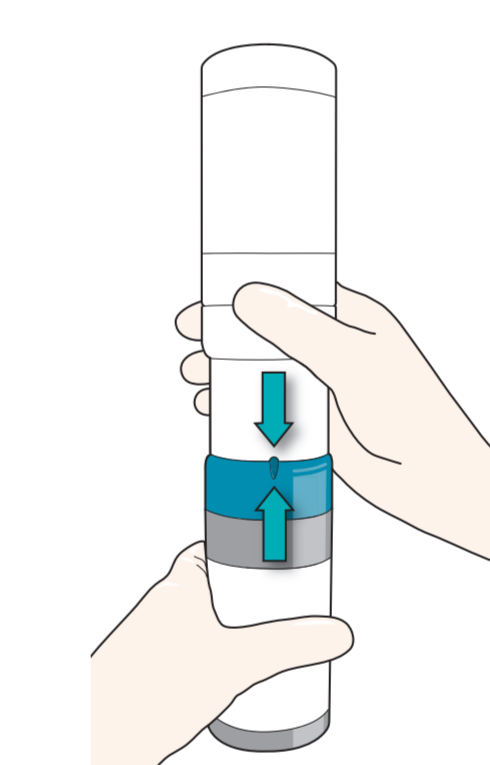
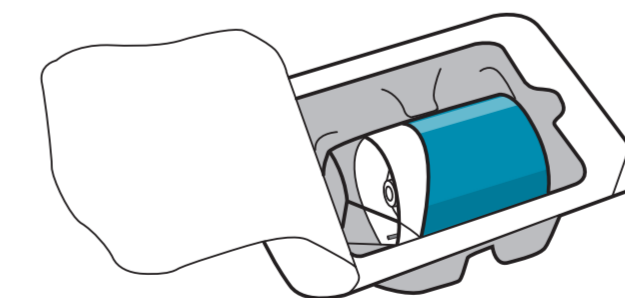

Figure 7



- Note:** In order to maintain sterility of the VARITHENA transfer unit, the following steps must be followed. While waiting 1 minute for the gas transfer, open a new VARITHENA transfer unit, blister pack, but leave the VARITHENA transfer unit in the package (Figure 8). The manometer tubing (20 inch) should have been previously filled with sterile heparinized normal saline solution.

Figure 8



- After 1 minute,
 - Twist the two canisters by turning them in the opposite direction (counterclockwise) as before (Figure 9).
 - Pull straight up to separate the oxygen canister from the VARITHENA canister, as shown (Figure 10). Do not separate canisters until you have a VARITHENA transfer unit ready to place onto the VARITHENA canister (See step 6).
 - Put the oxygen canister (with white collar) aside.
 - The VARITHENA canister (with blue collar) should remain on a clean flat surface, in the upright position.

Figure 9

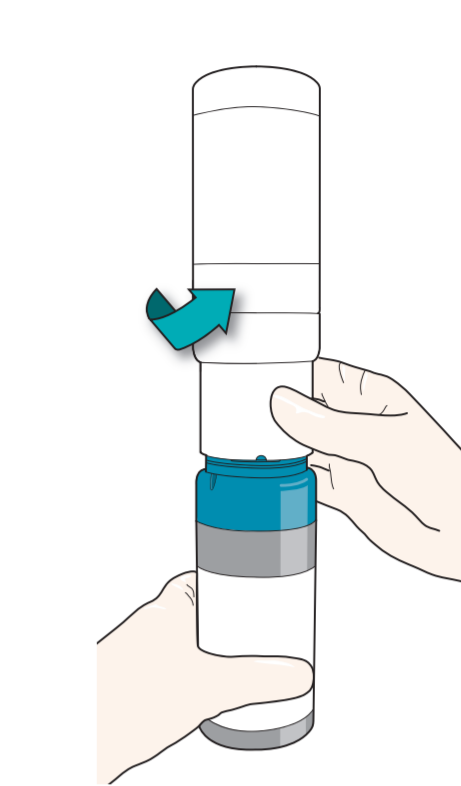
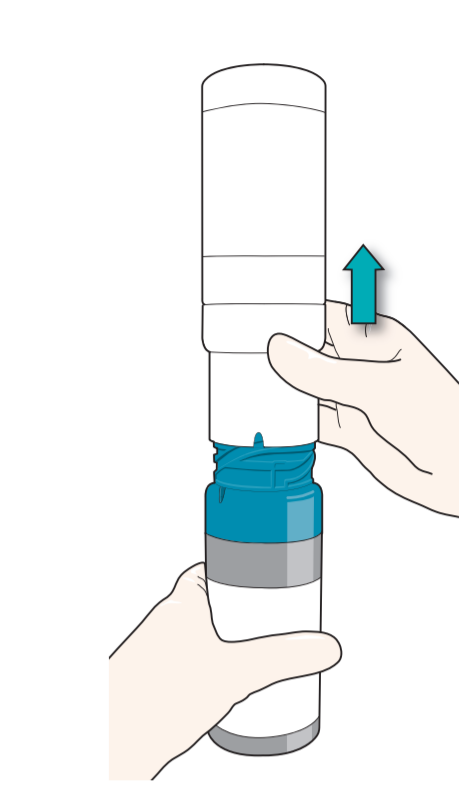

Figure 10



Write today's date and time in the "Date and Time of Activation" box on the VARITHENA canister (Figure 11)

Figure 11



Connecting a new VARITHENA transfer unit and syringe

6 Remove the VARITHENA transfer unit from the blister pack, wearing a fresh pair of sterile gloves. Make sure not to touch the sterile underside of the VARITHENA transfer unit, (discard VARITHENA transfer unit if contaminated).

Immediately place the VARITHENA transfer unit on top of the blue VARITHENA canister. Gently rotate the VARITHENA transfer unit clockwise as indicated (Figure 12) until it drops into the collar threads then twist the VARITHENA transfer unit (clockwise) until it reaches a stop (Figure 13).

Figure 12

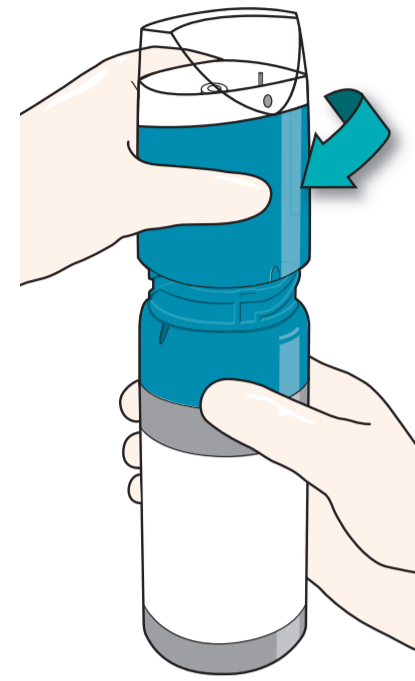
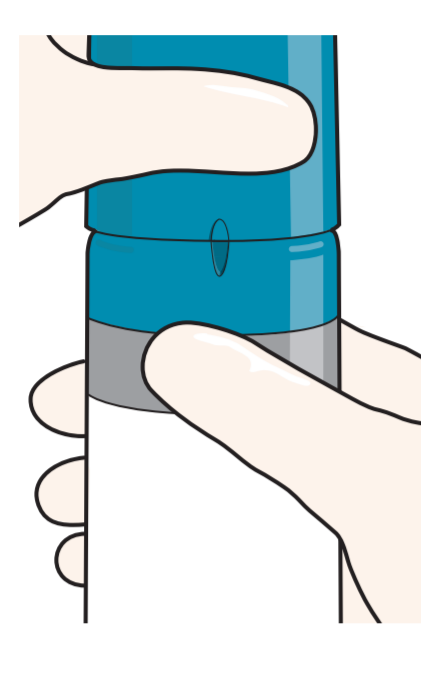

Figure 13



The system is now activated and ready for use.

7 Once all preparations for injection are complete, i.e., cannula *in situ*, patient's leg elevated and a good ultrasound view of the saphenofemoral junction (SFJ) obtained, foam may be generated for immediate use.

Open a sterile 10 mL silicone-free syringe blister pack and keep it in the package until needed.

Remove the syringe from the package, and connect it to the VARITHENA transfer unit as shown (Figure 14).

Figure 14

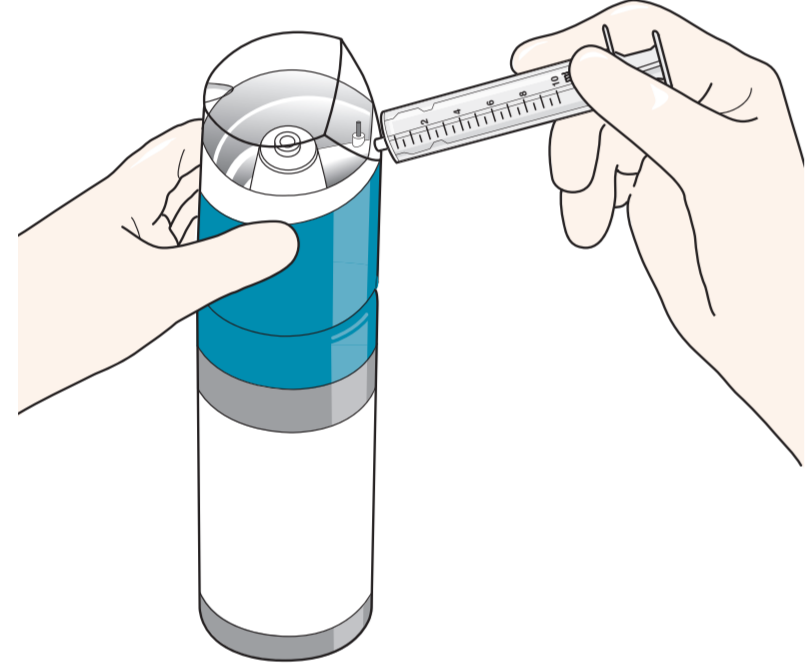

Priming a New Syringe

8 Gently press down the VARITHENA transfer unit to begin producing foam (Figure 15).

Using continuous pressure, allow the silicone-free syringe to fill between 3 mL and 5 mL.

Release the pressure on the VARITHENA transfer unit and leave the syringe connected.

Figure 15

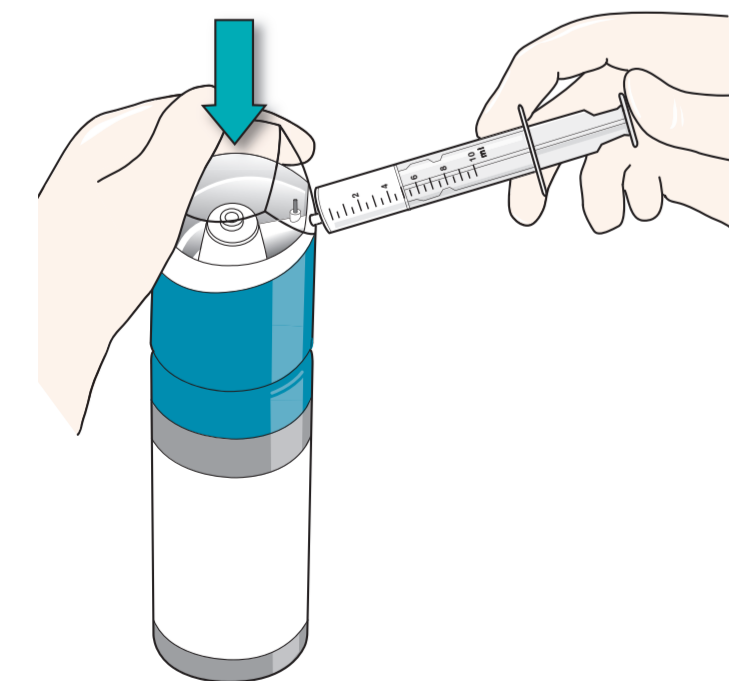

9 Push the silicone-free syringe plunger in fully to discard its contents (Figure 16). Do not disconnect the syringe.

Figure 16

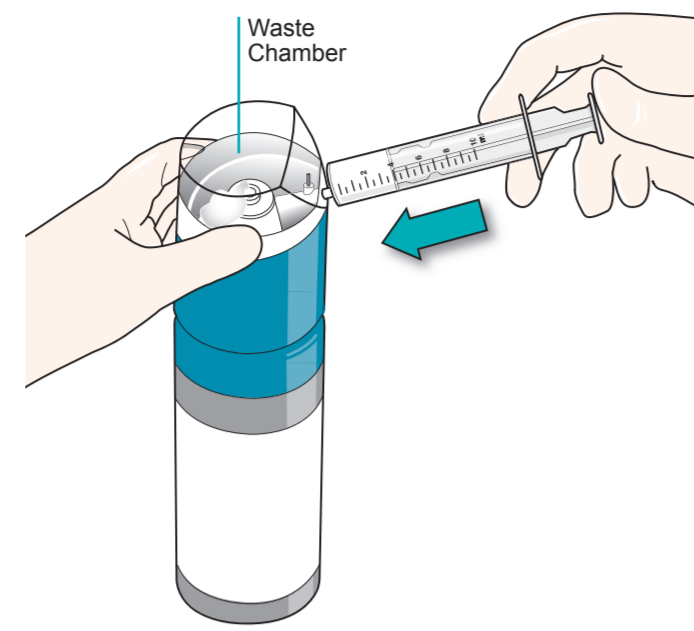

Note: The foam will automatically be diverted into the waste chamber within the VARITHENA transfer unit (Figure 17). This process eliminates the small quantity of air in the syringe and VARITHENA transfer unit.

Figure 17

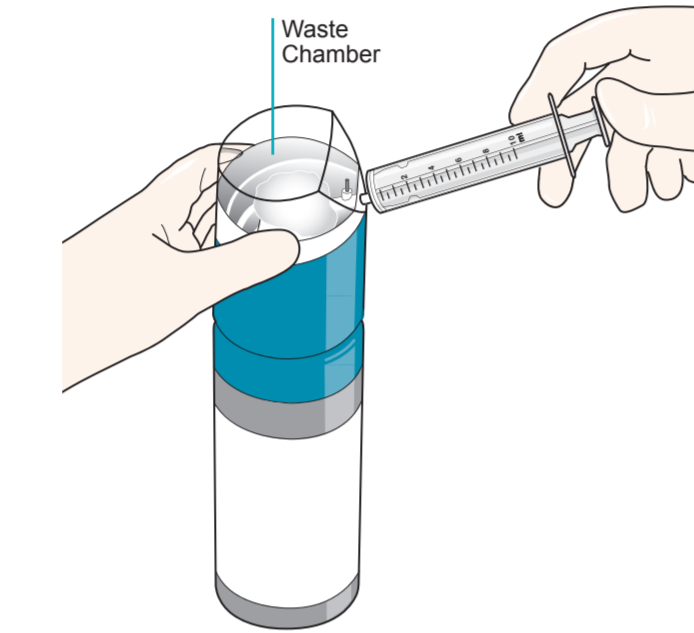

Generation of Foam

10 Foam Generation: The technique to produce usable foam requires a single purge cycle before filling the syringe, a process that takes less than 1 second.

Important Note: Foam must be generated by pushing down on the VARITHENA transfer unit continuously without pulling back on the plunger of the syringe (aspirating).

While holding the silicone-free syringe plunger in place, gently press down on the VARITHENA transfer unit to begin the purge cycle (Figure 18).

Figure 18

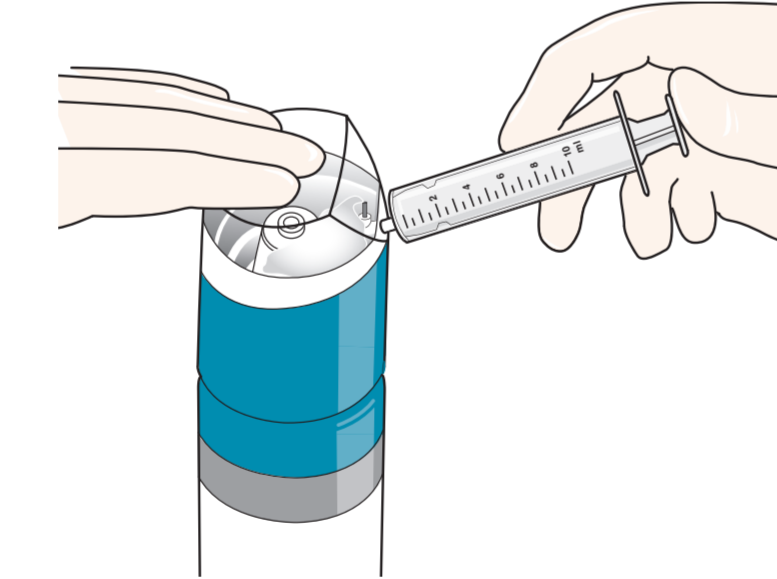

Visually inspect the flowing foam inside the VARITHENA transfer unit to make sure the visible air bubbles have been expelled (less than 1 second) before releasing the syringe plunger and allowing it to fill to the desired volume (Figure 19).

Draw up to 5 mL of foam into the syringe.

Figure 19

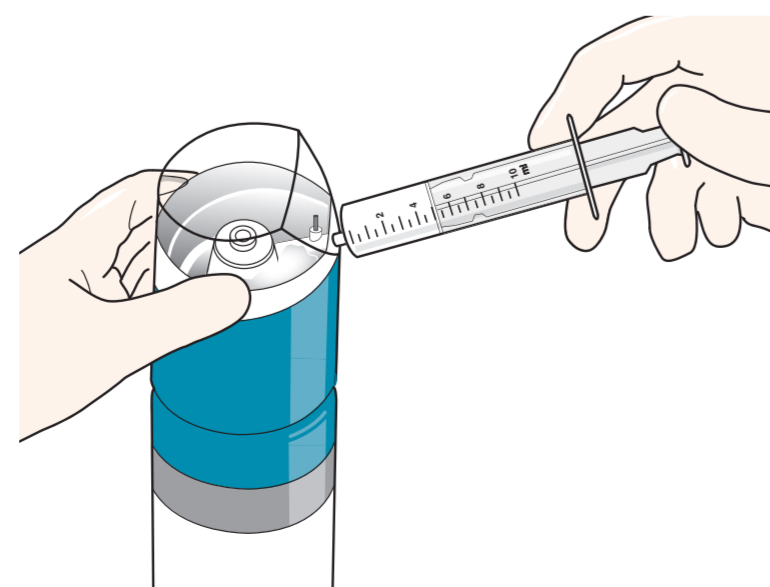

Inspecting and Injecting Foam

11 After the silicone-free syringe has filled to the desired volume, wait 10 seconds to allow the pressure to equalize before removing the syringe from the VARITHENA transfer unit (Figure 20).

WARNING: As the foam fills the syringe and before injecting, inspect the syringe full of foam for any visible bubbles (easily seen with the unaided eye at arm's length). If there are any present, empty the foam into the VARITHENA transfer unit waste chamber and refill the syringe.

Figure 20

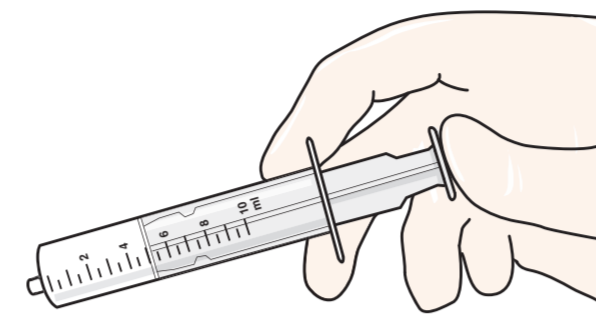

12 Remove the syringe from the VARITHENA transfer unit and inspect it for visible bubbles (Figure 21).

If no visible bubbles are present then the foam is ready for use.

Use the foam within 75 seconds of generation or discard and generate new foam.

WARNING: The total amount of foam injected in any one treatment session must not exceed 15 mL, comprised of individual injections of up to 5 mL each.

Figure 21

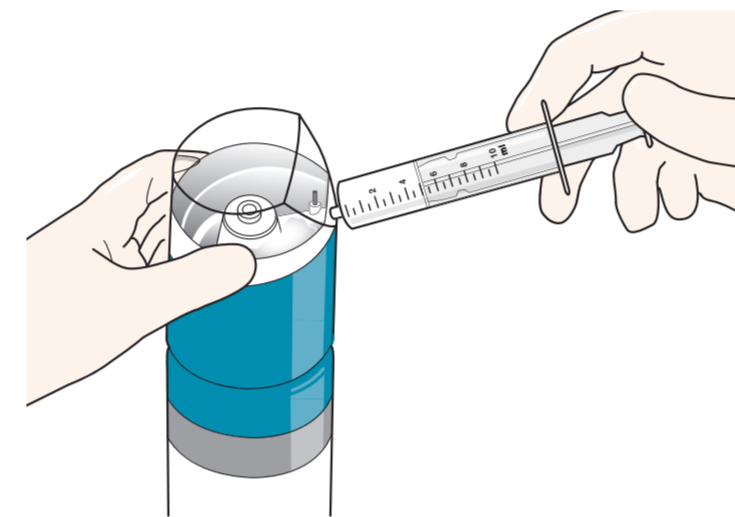

After each treatment session, mark-off on the canister label the number of aliquots of up to 5 mL of usable foam drawn from the canister per step 11 (Figure 22).

Figure 22



13 Connect a syringe of freshly generated foam to the manometer tubing, which is already connected to the cannula, in preparation for the initial injection. The manometer tubing (20) inch should have been previously filled with sterile heparinized normal saline solution.

14 Inject the foam at approximately 0.5 mL to 1.0 mL per second through the manometer tubing. Five (5) mLs of foam should be injected in approximately 10 seconds. Always inspect the foam as it passes through the manometer tubing for visible bubbles (Figure 23). If any visible bubbles are seen (easily seen with the unaided eye at arm's length) they should be aspirated back into the silicone-free syringe and the syringe contents discarded back into the VARITHENA transfer unit waste chamber, and a fresh syringe of foam generated.

Notes: Use a new sterile syringe after each injection.

Figure 23

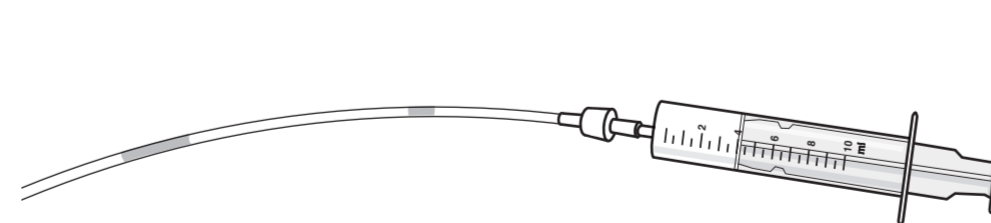

WARNING: The total amount of foam injected in any one treatment session must not exceed 15 mL, comprised of individual injections of up to 5 mL each.

Do not remove VARITHENA transfer unit if the VARITHENA canister is to be stored (see Storage)

Change sterile gloves appropriately, to limit any contamination of the VARITHENA transfer unit and Bi-Canister.

Compression Pads

15 Once treatment is complete, the Compression Pads should be used:

The objective of the pads is to focus the compression forces on the treated vein to keep them as free from blood as possible, thus minimizing retained thrombus.

The compression pads supplied should be placed along the course of the treated trunk vein in the thigh, and over raised treated varicose veins above and below the knee. The pads may be shaped to follow the course of the veins. The pads should be placed outside the first layer of limited stretch bandage and held in place by a second layer of bandage.

The appropriate length compression stocking is then applied.

Replacing the VARITHENA Transfer Unit

Important Note: Do not replace the VARITHENA transfer unit if the canister is to be stored for future use. The activated VARITHENA canister should always be stored in an appropriately cleaned area with a VARITHENA transfer unit in place in the upright position at or below 86°F (30°C). Replace the VARITHENA transfer unit just prior to the next treatment session.

16 Wearing appropriate new sterile gloves, hold the VARITHENA canister, twist the VARITHENA transfer unit counterclockwise and then pull up to separate from the canister (Figure 24).

Figure 24

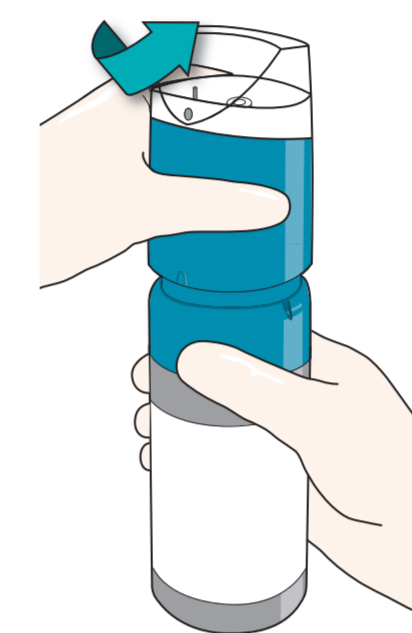

17 Discard the old VARITHENA transfer unit and open a new VARITHENA transfer unit. Make sure not to touch the sterile underside of the VARITHENA transfer unit.

18 Swab the uncovered shuttle with a fresh sterile alcohol wipe (Figure 25) and immediately place the VARITHENA transfer unit on top of the VARITHENA canister.

Figure 25

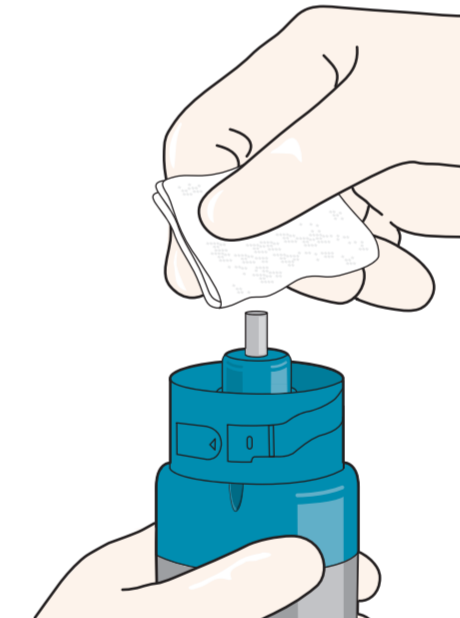

Gently rotate the VARITHENA transfer unit clockwise until it drops into the collar threads (Figure 26), then twist the VARITHENA transfer unit (clockwise) until it reaches a stop (Figure 27).

Figure 26

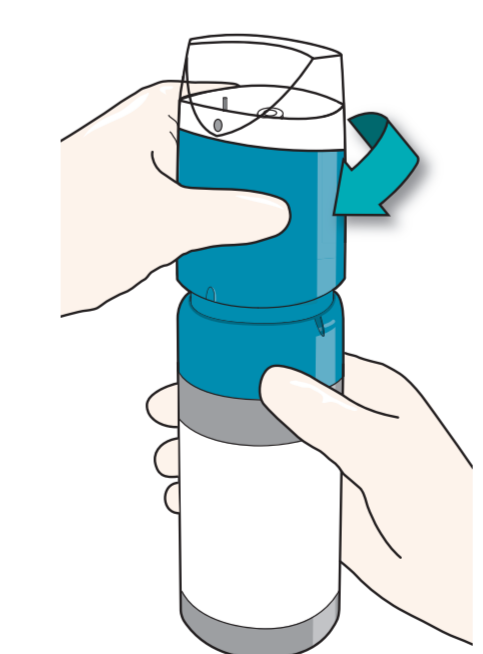
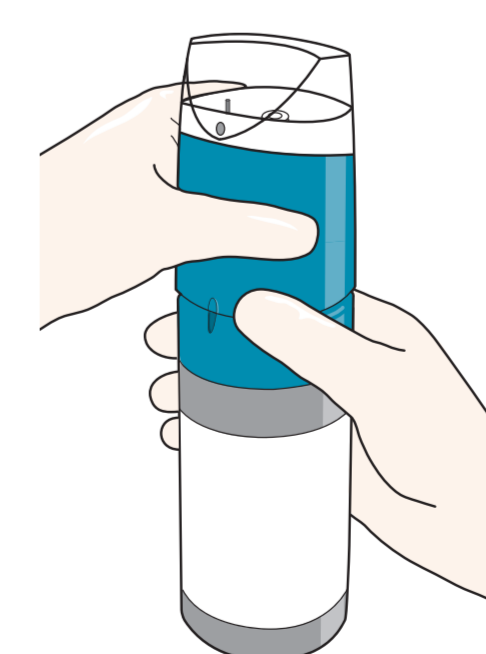

Figure 27



The VARITHENA device now ready for use for a new treatment session, following the instructions in Steps 7 to 15.

Storage and Disposal

Note: The activated VARITHENA canister should always be stored with a VARITHENA transfer unit in place in the upright position. Store at or below 86°F (30°C) in an appropriately controlled clean area to limit contamination.

Dispose of VARITHENA and oxygen canisters following local and state regulations for aerosol disposal.

The VARITHENA transfer unit can be disposed of as non-toxic non-clinical waste.

180 mg/18 mL Configuration:	77.5 mg/7.75 mL Configuration:
Once the VARITHENA canister has been activated, the shelf life for the product is thirty (30) calendar days. Always write the activation date and time on the canister and verify the product has not expired prior to use.	Once the VARITHENA canister has been activated, the shelf life for the product is thirty (30) calendar days. Always write the activation date and time on the canister and verify the product has not expired prior to use.
Net Contents: 18 mL	Net Contents: 7.75 mL
One canister of VARITHENA in the 180 mg/18 mL Configuration contains:	One canister of VARITHENA in the 77.5 mg/7.75 mL Configuration contains:
180 mg Polidocanol, 756 mg ethanol (96%), 43.2 mg disodium hydrogen phosphate dihydrate, 15.3 mg potassium dihydrogen phosphate, water for injection.	77.5 mg Polidocanol, 325.5 mg ethanol (96%), 18.6 mg disodium hydrogen phosphate dihydrate, 6.6 mg potassium dihydrogen phosphate, water for injection.
One canister of VARITHENA generates 90 mL of foam which, following purging instructions contained in this IFU, is sufficient to yield 45 mL of usable foam for injection. The gas mix of the foam is 65:35 O ₂ :CO ₂ .	One canister of VARITHENA generates 30 mL of foam which, following purging instructions contained in this IFU, is sufficient to yield 15 mL of usable foam for injection. The gas mix of the foam is 65:35 O ₂ :CO ₂ .
NDC 60635-118-01 VARITHENA 180 mg/18 mL Bi-Canister Administration Pack NDC 60635-133-01 VARITHENA 180 mg/18 mL Convenience Pack NDC 60635-018-01 180 mg/18 mL PD Canister	NDC 60635-107-01 VARITHENA 77.5 mg/7.75 mL Bi-Canister Administration Pack NDC 60635-111-01 VARITHENA 77.5 mg/7.75 mL Convenience Pack NDC 60635-007-01 77.5 mg/7.75 mL PD Canister

Manufactured for Provensis Ltd by: Biocompatibles UK Ltd Chapman House, Weydon Lane, Farnham, Surrey, UK, GU9 8QL

Distributed by: Biocompatibles Inc.

VARITHENA is a registered trademark of Provensis Ltd

BTG and the BTG roundel logo are registered trademarks of BTG International Ltd

Provensis Ltd, Biocompatibles UK Ltd, and Biocompatibles Inc. are BTG International group companies

Varithena[®]
(polidocanol injectable foam)

